



### General Description

AF1860 is the monolithic IC designed for a step-down DC/DC converter capable of driving 3A load without an additional transistor. The input voltage range is up to 60V. Its feedback voltage,  $V_{FB}$ , is 200mV. The AF1860 operates at a switching frequency of 52kHz. The external shutdown function is controlled by a logic level on the ON/OFF pin and then the circuit comes into the standby mode with  $I_{STBY} \sim 50\mu A$  (typ.). The ON/OFF pin may be used for the analog dimming. As the voltage on the ON/OFF pin is increased from 0.07V to 0.67V, the voltage on the FB pin falls from 200mV to 0V.

The self-protection features include a cycle-by-cycle current limit and a thermal protection.

The AF1860 is available in standard TO-263-5L packages and SOP-8EP package.

### Features

- $V_{IN Max} = 60V$
- $V_{FB} = 200mV$
- Frequency 52kHz
- $I_{LED Max} 1.5A$  ( PSOP-8 )
- $I_{LED Max} 3.0A$  ( TO-263-5L )
- On/Off input may be used for the Analog Dimming
- Thermal protection
- Cycle-by-cycle current limit

### Application

- DC-DC or AC-DC LED driver applications
- Back lighting of flat panel displays
- General purpose constant current source
- Automotive
- Chargers

### Pin Define

#### SOP-8EP

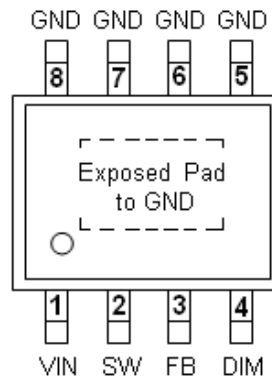

#### TO-263-5L

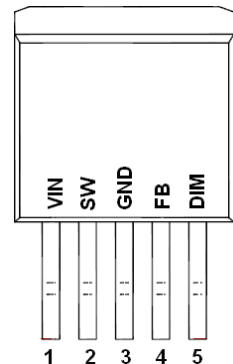

### Marking Information

#### SOP-8EP

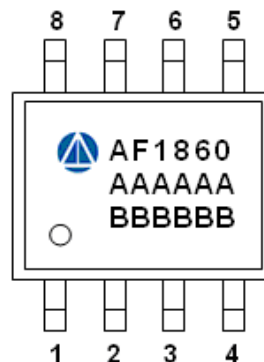

#### TO-263-5L

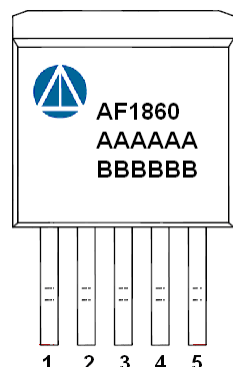



**Typical Application Circuit**

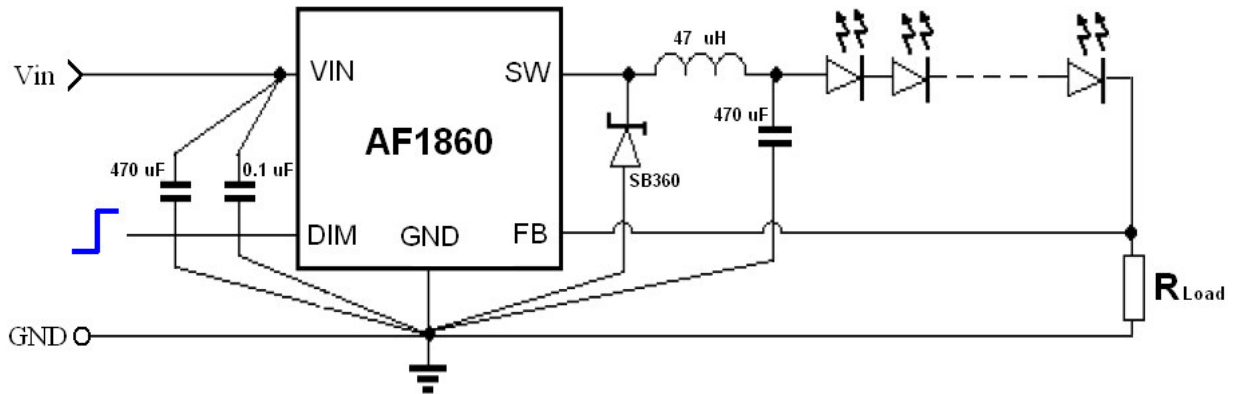

**SOP-8EP Pin Description**

| Pin | Symbol | Description          |
|-----|--------|----------------------|
| 1   | VIN    | Supply Voltage Input |
| 2   | SW     | Switching            |
| 3   | FB     | Feedback             |
| 4   | DIM    | On/Off & Dimming     |
| 5   | GND    | Ground               |
| 6   | GND    | Ground               |
| 7   | GND    | Ground               |
| 8   | GND    | Ground               |

**TO-263-5L Pin Description**

| Pin | Symbol | Description          |
|-----|--------|----------------------|
| 1   | VIN    | Supply Voltage Input |
| 2   | SW     | Switching            |
| 3   | GND    | Ground               |
| 4   | FB     | Feedback             |
| 5   | DIM    | On/Off & Dimming     |

**Ordering Information**

| Part Ordering No. | Part Marking | Package                    | Unit        | Quantity |
|-------------------|--------------|----------------------------|-------------|----------|
| AF1860S8EPRG      | AF1860       | SOP-8EP<br>( Exposed Pad ) | Tape & Reel | 2500 EA  |
| AF1860T265RG      | AF1860       | TO-263-5L                  | Tape & Reel | 800 EA   |

- ※ A Lot Code
- ※ B Date Code
- ※ AF1860S8EPRG : 13" Tape & Reel ; Pb- Free ; Halogen- Free
- ※ AF1860T265RG : 13" Tape Reel ; Pb- Free ; Halogen- Free



**Block Diagram**

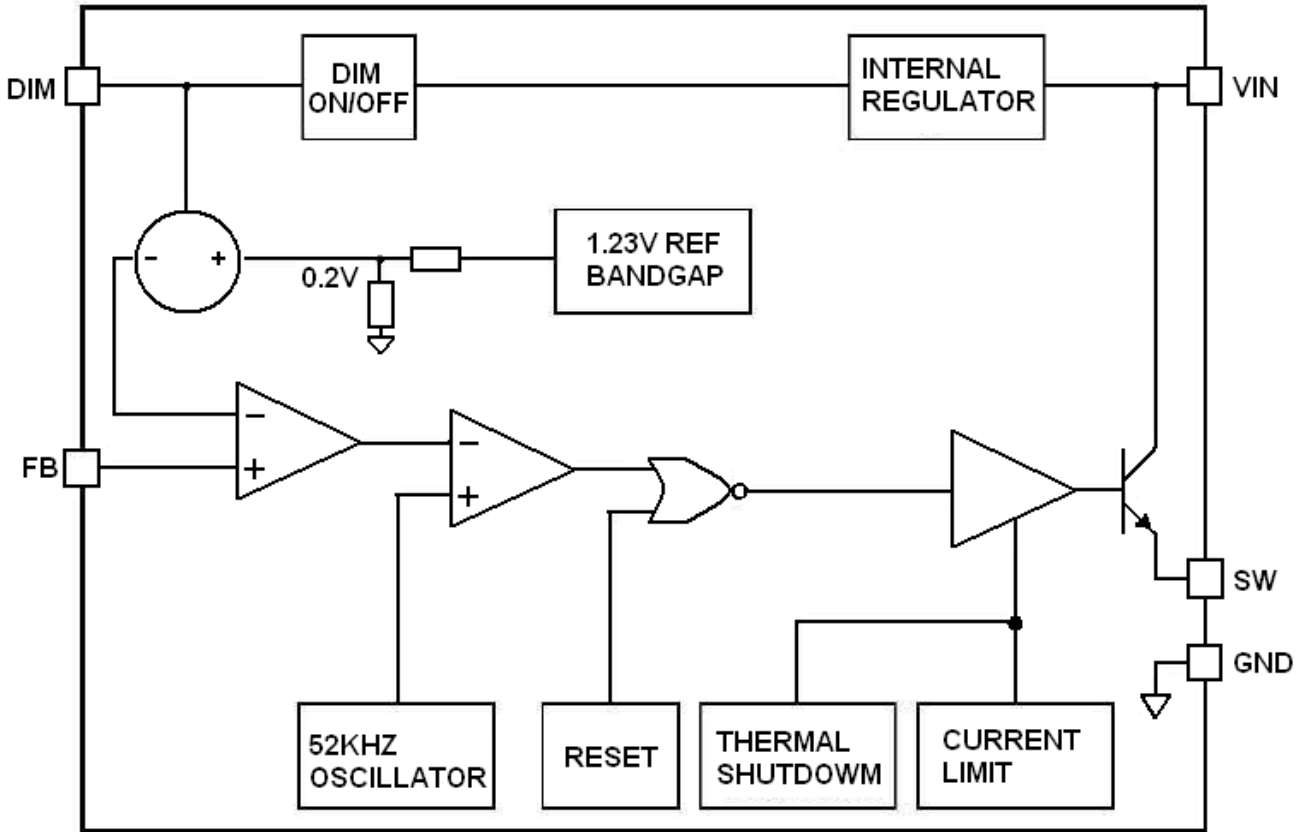

**Absolute Maximum Ratings** ( $T_A=25^{\circ}\text{C}$  Unless otherwise noted)

| Parameter                    | Symbol       | Value          | Unit               |
|------------------------------|--------------|----------------|--------------------|
| DC Supply Voltage            | $V_{IN}$     | 63             | V                  |
| ON/OFF and Dimming Voltage   | DIM          | -0.3~ $V_{IN}$ | V                  |
| SW Voltage                   | SW           | -0.8           | V                  |
| FB Voltage                   | FB           | -0.3~ $V_{IN}$ | V                  |
| Operating Temperature        | $T_{OPR}$    | -40 ~ 125      | $^{\circ}\text{C}$ |
| Maximum Junction Temperature | $T_{J(Max)}$ | 150            | $^{\circ}\text{C}$ |
| Storage Temperature          | $T_S$        | -65 ~ 150      | $^{\circ}\text{C}$ |

The IC has a protection circuit against static electricity ( $> 2\text{KV}$ ). Do not apply high static electricity or high voltage that exceeds the performance of the protection circuit to the IC.



**Electrical Characteristics**

( $T_j=25^{\circ}\text{C}$ ,  $V_{IN}=12\text{V}$ ,  $I_{LOAD}=350\text{mA}$  Unless otherwise specified)

| Symbol     | Parameter             | Conditions  | Min. | Typ.  | Max. | Unit |
|------------|-----------------------|---|------|-------|------|------|
| $V_{IN}$   | Operating Voltage     |   | 5.5  |       | 60   | V    |
| $V_{FB}$   | Feedback Voltage      | $V_{IN} = 12\text{V}$ , $I_{LOAD} = 350\text{mA}$ , $DIM = 0\text{V}$                     | 190  | 200   | 210  | mV   |
|            |                       | $V_{IN} = 5.5\text{V}\sim 60\text{V}$ , $I_{LOAD} = 350\text{mA}$ , $V_{DIM} = 0\text{V}$ | 180  |       | 220  | mV   |
| $I_{FB}$   | Feedback Current      | $V_{FB} = 250\text{mV}$ , $DIM = 0\text{V}$   | -150 | -50   | 150  | nA   |
| $F_{OSC}$  | Oscillator Frequency  |   | 47   | 52    | 58   | KHz  |
| $V_{SAT}$  | Saturation Current    | $I_{SW}=1.5\text{A}$ SOP-8EP  |      | 1.35  | 1.5  | V    |
|            |                       | $I_{SW}=3.0\text{A}$ TO-263-5L  |      | 1.5   | 1.8  | V    |
| $D_{MAX}$  | Max Duty              |   |      |       | 100  | %    |
| $I_{LO}$   | SW Leakage Current    | $V_{IN}=50\text{V}$ , $V_{FB} = 1.5\text{V}$ , $V_{SW} = 0\text{V}$                       | -0.3 | -0.07 |      | mA   |
| $CL$       | Current Limit         | SOP-8EP   | 1.5  |       | 4.0  | A    |
|            |                       | TO-263-5L   | 2.7  |       | 6.0  | A    |
| $V_{TH}$   | DIM Threshold Voltage |   | 1.0  | 1.4   | 2.0  | V    |
| $I_{IH}$   | Input Current On/Off  | $V_{On/Off} = 2.5\text{V}$  | -1.0 | 0.01  | 1.0  | uA   |
| $I_{IL}$   | Input Current On/Off  | $V_{On/Off} = 0\text{V}$  | -1.0 | -0.3  | 1.0  | uA   |
| $I_Q$      | Quiescent Current     | $V_{FB} = 1.5\text{V}$  |      | 5.3   | 10   | mA   |
| $I_{STBY}$ | Standby Current       | $V_{IN}=50\text{V}$ , $V_{DIM} = 5\text{V}$   |      | 50    | 200  | uA   |
| $V_{DIM}$  | Dimming Voltage       | $V_{IN} = 12\text{V}$ , $I_{LOAD} = 0$  | 600  | 670   | 750  | mV   |

**Note :**

LED must be ensured with load current ( $I_{LOAD}$ ) at  $V_{IN Min.}$

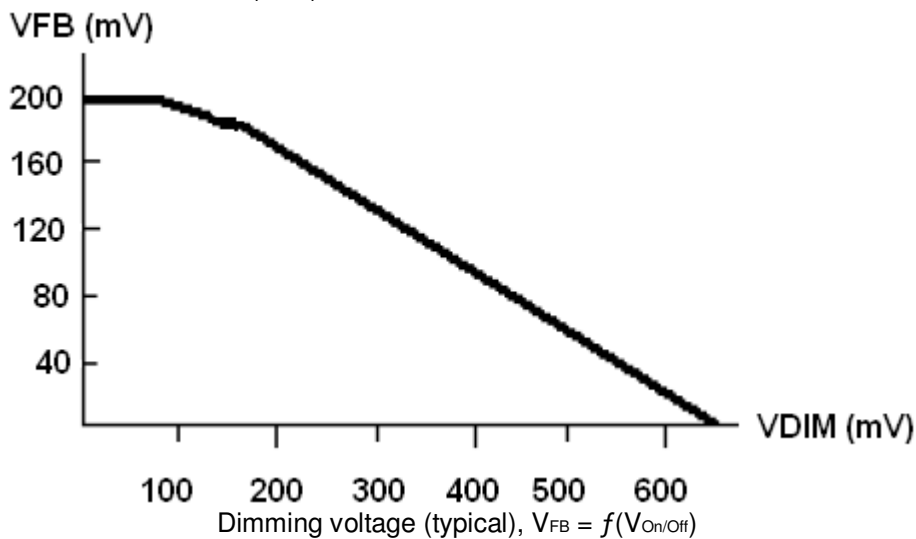



## Typical Performance Characteristics

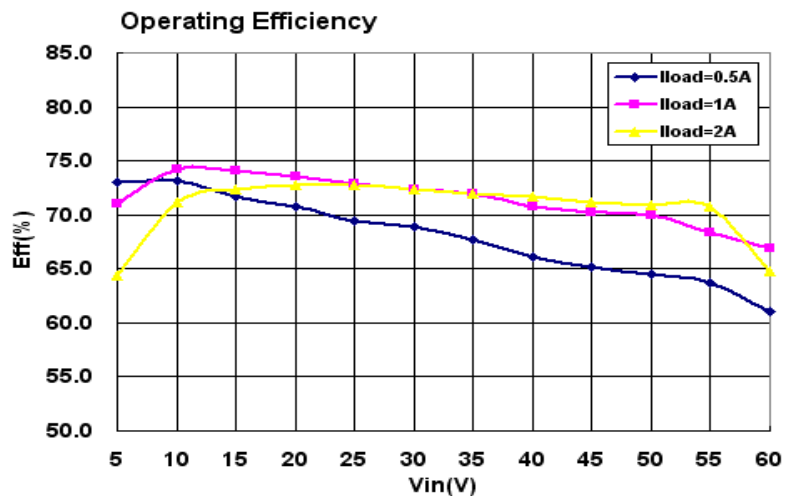
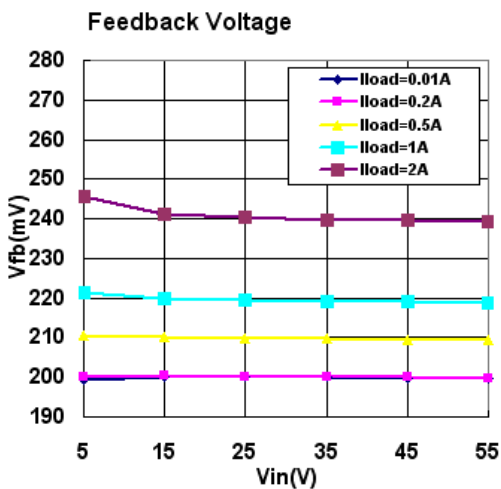
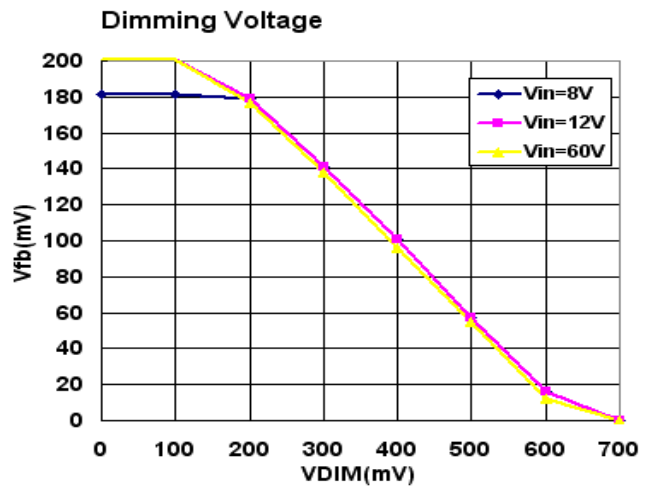
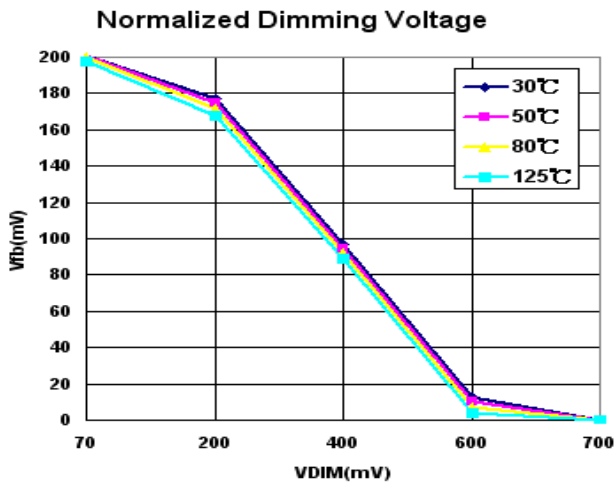
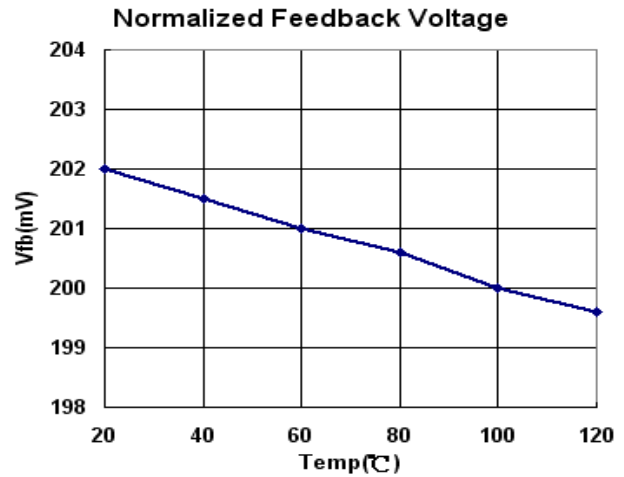
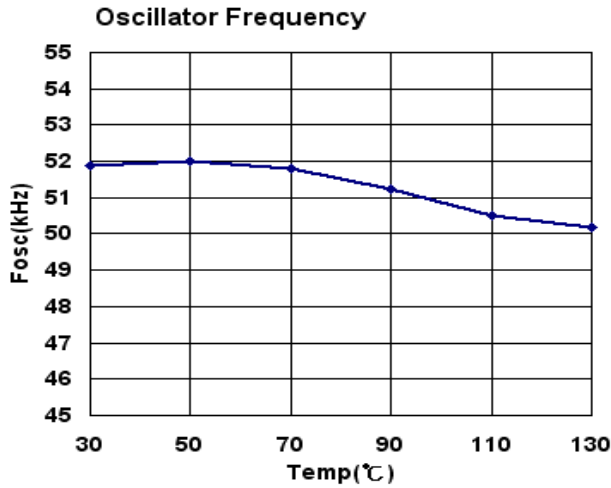



**Package Information ( SOP-8EP )**

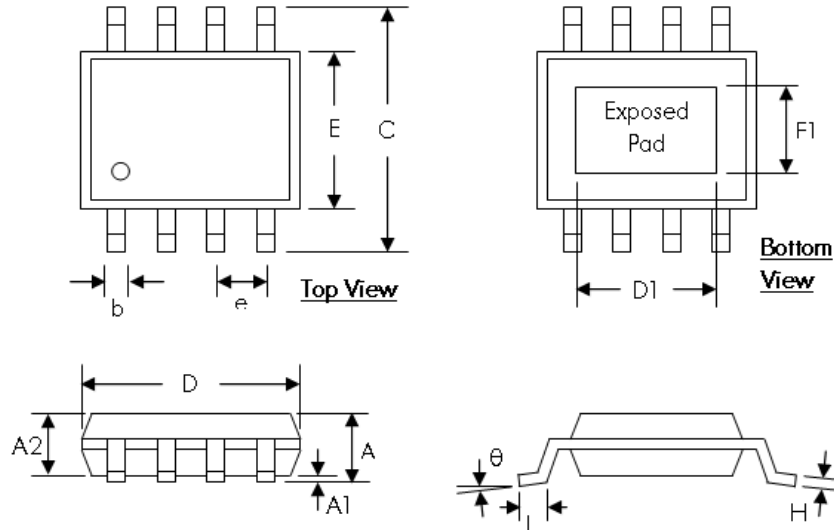

| SYMBOLS  | DIMENSION (MM) |      | DIMENSION (INCH) |        |
|----------|----------------|------|------------------|--------|
|          | MIN            | MAX  | MIN              | MAX    |
| A        | 1.30           | 1.70 | 0.051            | 0.067  |
| A1       | 0.00           | 0.15 | 0.000            | 0.006  |
| A2       | 1.25           | 1.52 | 0.049            | 0.060  |
| b        | 0.33           | 0.51 | 0.013            | 0.020  |
| C        | 5.80           | 6.20 | 0.228            | 0.244  |
| D        | 4.80           | 5.11 | 0.189            | 0.201  |
| D1       | 3.15           | 3.45 | 0.124            | 0.136  |
| E        | 3.80           | 4.00 | 0.150            | 0.157  |
| E1       | 2.26           | 2.56 | 0.089            | 0.101  |
| e        | 1.27 BSC       |      | 0.050 BSC        |        |
| H        | 0.19           | 0.25 | 0.0075           | 0.0098 |
| L        | 0.41           | 1.27 | 0.016            | 0.050  |
| $\theta$ | 0°             | 8°   | 0°               | 8°     |

©2010 Alfa-MOS Technology Corp.  
 2F, No.80, Sec.1, Cheng Kung Rd., Nan Kang Dist., Taipei City 115, Taiwan (R.O.C.)  
 Tel : 886 2) 2651 3928  
 Fax : 886 2) 2786 8483  
 ©http://www.alfa-mos.com



**Package Information ( TO-263-5L )**

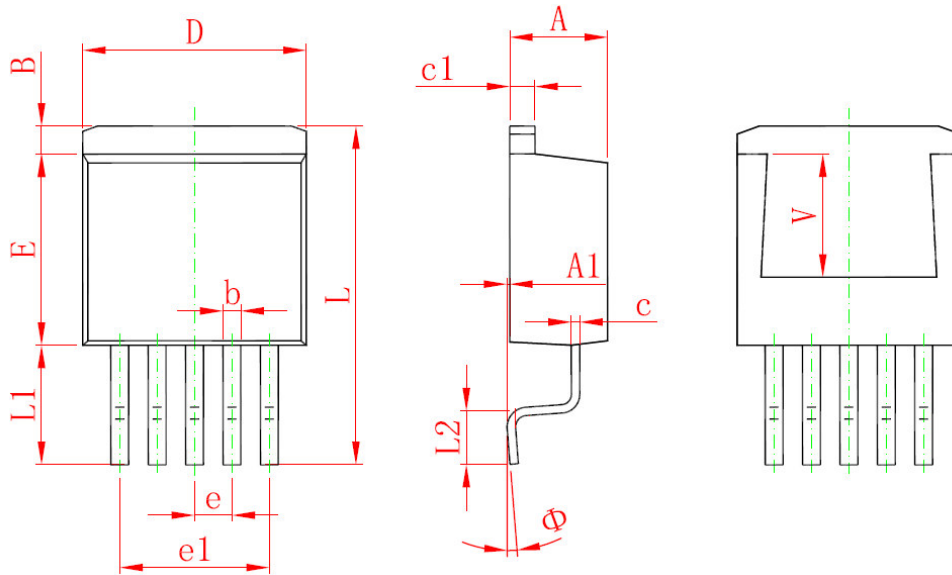

| Symbol | Dimensions In Millimeters |        | Dimensions In Inches |       |
|--------|---------------------------|--------|----------------------|-------|
|        | Min.                      | Max.   | Min.                 | Max.  |
| A      | 4.470                     | 4.670  | 0.176                | 0.184 |
| A1     | 0.000                     | 0.150  | 0.000                | 0.006 |
| B      | 1.560                     | 1.760  | 0.061                | 0.069 |
| b      | 0.710                     | 0.910  | 0.028                | 0.036 |
| c      | 0.310                     | 0.530  | 0.012                | 0.021 |
| c1     | 1.170                     | 1.370  | 0.046                | 0.054 |
| D      | 9.880                     | 10.180 | 0.389                | 0.401 |
| E      | 8.200                     | 8.600  | 0.323                | 0.339 |
| e      | 1.700 TYP.                |        | 0.067 TYP.           |       |
| e1     | 6.700                     | 6.900  | 0.264                | 0.272 |
| L      | 15.140                    | 15.540 | 0.596                | 0.612 |
| L1     | 5.080                     | 5.480  | 0.200                | 0.216 |
| L2     | 2.340                     | 2.740  | 0.092                | 0.108 |
| Φ      | 0°                        | 8°     | 0°                   | 8°    |
| V      | 5.600 REF.                |        | 0.220 REF.           |       |

©2010 Alfa-MOS Technology Corp.  
2F, No.80, Sec.1, Cheng Kung Rd., Nan Kang Dist., Taipei City 115, Taiwan (R.O.C.)  
Tel : 886 2) 2651 3928  
Fax : 886 2) 2786 8483  
©http://www.alfa-mos.com