

## Low IR Schottky barrier diode

### Features

- Low IR
- Low VF
- Center tap connection

### Applications

- High frequency operation
- DC-DC converters
- AC adapter

### Outline drawings, mm

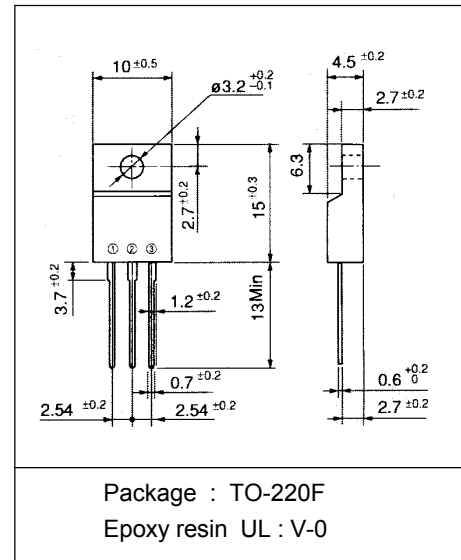

### Connection diagram

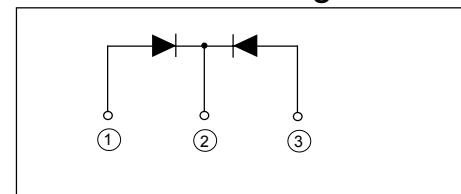

### Maximum ratings and characteristics

#### Maximum ratings

Item	Symbol	Conditions	Rating	Unit
Repetitive peak surge reverse voltage	$V_{RSM}$	tw=500ns, duty=1/40	60	V
Repetitive peak reverse voltage	$V_{RRM}$		60	V
Isolating voltage	Viso	Terminals-to-Case, AC. 1min.	1500	V
Average output current	$I_o$	Square wave, duty=1/2 $T_c=109^{\circ}C$	20 *	A
Non-repetitive surge current	$I_{FSM}$	Sine wave 10ms	145	A
non-repetitive reverse surge power dissipation	PRM	tw=10μs, $T_j=25^{\circ}C$	660	W
Operating junction temperature	$T_j$		+150	$^{\circ}C$
Storage temperature	$T_{stg}$		-40 to +150	$^{\circ}C$

\* Out put current of center tap full wave connection

#### Electrical characteristics (at $T_a=25^{\circ}C$ Unless otherwise specified )

Item	Symbol	Conditions	Max.	Unit
Forward voltage **	$V_F$	$I_F=10A$	0.74	V
Reverse current **	$I_R$	$V_R=60V$	175	μA
Thermal resistance	$R_{th(j-c)}$	Junction to case	2.5	$^{\circ}C/W$

\*\*Rating per element

#### Mechanical characteristics

Mounting torque	Recommended torque	0.3 to 0.5	N·m
Approximate mass		2	g

■ Characteristics

Forward Characteristic (typ.)

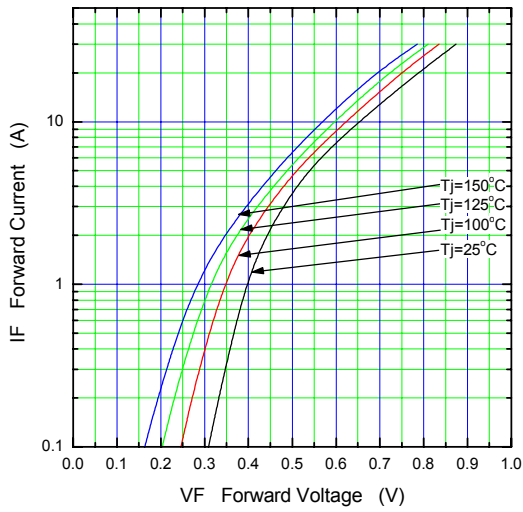

Reverse Characteristic (typ.)

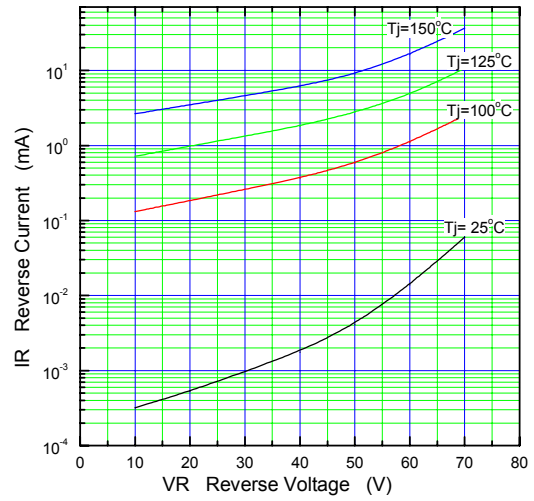

Forward Power Dissipation (max.)

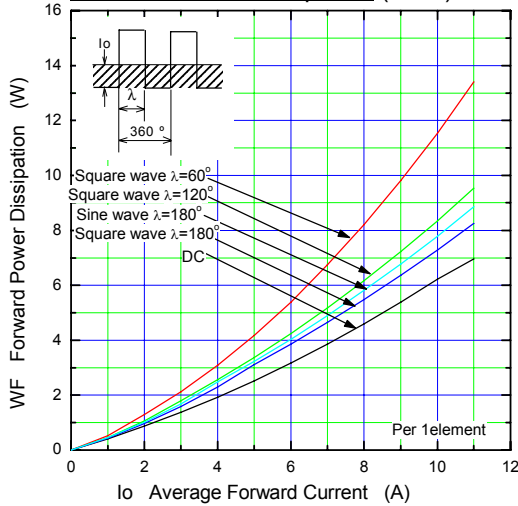

Reverse Power Dissipation (max.)

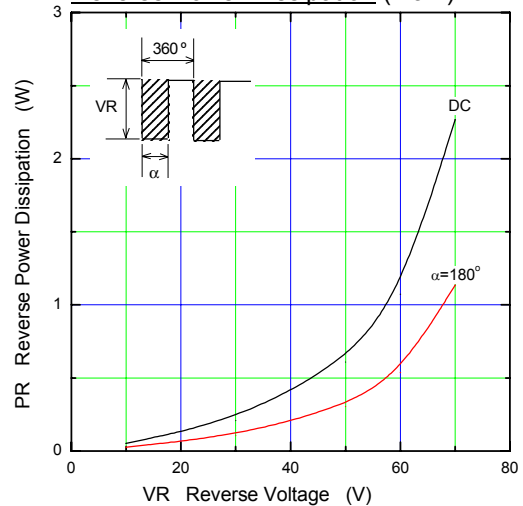

Current Derating (Io-Tc) (max.)

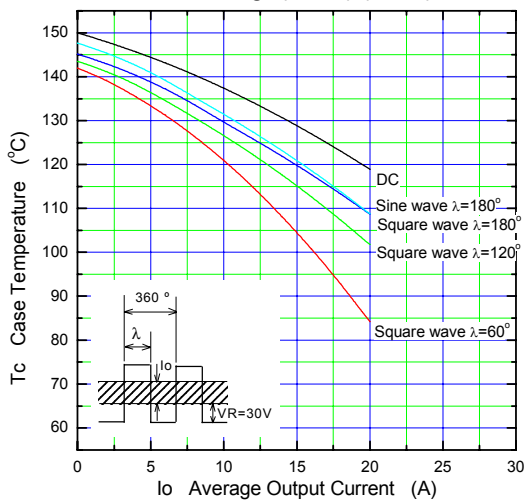

Junction Capacitance Characteristic (max.)

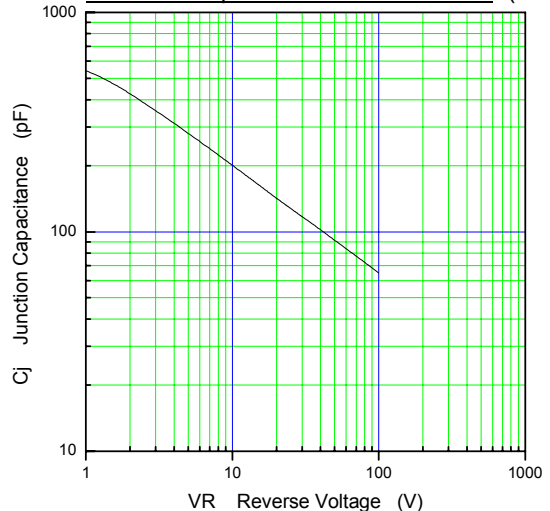

λ: Conduction angle of forward current for each rectifier element  
Io: Output current of center-tap full wave connection

