

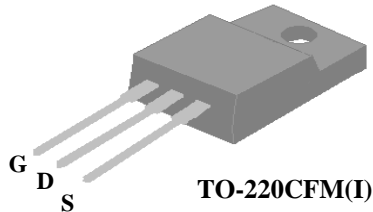

- ▼ Lower On-resistance
- ▼ Simple Drive Requirement
- ▼ Fast Switching Characteristic



$BV_{DSS}$	-100V
$R_{DS(ON)}$	160m $\Omega$
$I_D$	-12A

**Description**

Advanced Power MOSFETs from APEC provide the designer with the best combination of fast switching, ruggedized device design, low on-resistance and cost-effectiveness.

The TO-220CFM isolation package is widely preferred for commercial -industrial through hole applications.

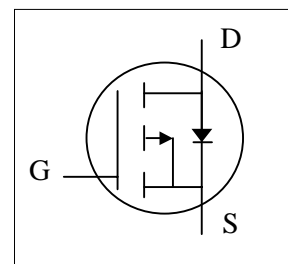

**Absolute Maximum Ratings**

Symbol	Parameter	Rating	Units
$V_{DS}$	Drain-Source Voltage	-100	V
$V_{GS}$	Gate-Source Voltage	$\pm 32$	V
$I_D@T_C=25^\circ C$	Continuous Drain Current, $V_{GS}$ @ 10V	-12	A
$I_D@T_C=100^\circ C$	Continuous Drain Current, $V_{GS}$ @ 10V	-10	A
$I_{DM}$	Pulsed Drain Current <sup>1</sup>	-48	A
$P_D@T_C=25^\circ C$	Total Power Dissipation	31.25	W
	Linear Derating Factor	0.25	W/ $^\circ C$
$E_{AS}$	Single Pulse Avalanche Energy <sup>2</sup>	40	mJ
$I_{AR}$	Avalanche Current	-9	A
$T_{STG}$	Storage Temperature Range	-55 to 150	$^\circ C$
$T_J$	Operating Junction Temperature Range	-55 to 150	$^\circ C$

**Thermal Data**

Symbol	Parameter	Value	Units
Rthj-c	Maximum Thermal Resistance, Junction-case	4.0	$^\circ C/W$
Rthj-a	Maximum Thermal Resistance, Junction-ambient	65	$^\circ C/W$



# AP18P10GI

## Electrical Characteristics @ $T_j=25^\circ\text{C}$ (unless otherwise specified)

Symbol	Parameter	Test Conditions	Min.	Typ.	Max.	Units
$BV_{DSS}$	Drain-Source Breakdown Voltage	$V_{GS}=0V, I_D=-250\mu A$	-100	-	-	V
$\Delta BV_{DSS}/\Delta T_j$	Breakdown Voltage Temperature Coefficient	Reference to $25^\circ\text{C}$ , $I_D=-1\text{mA}$	-	-0.1	-	$V/^\circ\text{C}$
$R_{DS(ON)}$	Static Drain-Source On-Resistance <sup>3</sup>	$V_{GS}=-10V, I_D=-8A$	-	-	160	$\text{m}\Omega$
		$V_{GS}=-4.5V, I_D=-6A$	-	-	200	$\text{m}\Omega$
$V_{GS(th)}$	Gate Threshold Voltage	$V_{DS}=V_{GS}, I_D=-250\mu A$	-1	-	-3	V
$g_{fs}$	Forward Transconductance	$V_{DS}=-10V, I_D=-8A$	-	8	-	S
$I_{DSS}$	Drain-Source Leakage Current ( $T_j=25^\circ\text{C}$ )	$V_{DS}=-100V, V_{GS}=0V$	-	-	-1	$\mu A$
	Drain-Source Leakage Current ( $T_j=150^\circ\text{C}$ )	$V_{DS}=-80V, V_{GS}=0V$	-	-	-25	$\mu A$
$I_{GSS}$	Gate-Source Leakage	$V_{GS}=\pm 32V$	-	-	$\pm 100$	nA
$Q_g$	Total Gate Charge <sup>3</sup>	$I_D=-8A$	-	16	25.6	nC
$Q_{gs}$	Gate-Source Charge	$V_{DS}=-80V$	-	4.4	-	nC
$Q_{gd}$	Gate-Drain ("Miller") Charge	$V_{GS}=-4.5V$	-	8.7	-	nC
$t_{d(on)}$	Turn-on Delay Time <sup>3</sup>	$V_{DS}=-50V$	-	9	-	ns
$t_r$	Rise Time	$I_D=-8A$	-	14	-	ns
$t_{d(off)}$	Turn-off Delay Time	$R_G=3.3\Omega, V_{GS}=-10V$	-	45	-	ns
$t_f$	Fall Time	$R_D=6.25\Omega$	-	40	-	ns
$C_{iss}$	Input Capacitance	$V_{GS}=0V$	-	1590	2550	pF
$C_{oss}$	Output Capacitance	$V_{DS}=-25V$	-	110	-	pF
$C_{rss}$	Reverse Transfer Capacitance	$f=1.0\text{MHz}$	-	70	-	pF
$R_g$	Gate Resistance	$f=1.0\text{MHz}$	-	8	12	$\Omega$

## Source-Drain Diode

Symbol	Parameter	Test Conditions	Min.	Typ.	Max.	Units
$V_{SD}$	Forward On Voltage <sup>3</sup>	$I_S=-12A, V_{GS}=0V$	-	-	-1.3	V
$t_{rr}$	Reverse Recovery Time <sup>3</sup>	$I_S=-8A, V_{GS}=0V,$	-	49	-	ns
$Q_{rr}$	Reverse Recovery Charge	$dI/dt=-100A/\mu s$	-	110	-	nC

### Notes:

1. Pulse width limited by Max. junction temperature.
2. Starting  $T_j=25^\circ\text{C}$ ,  $V_{DD}=-50V$ ,  $L=1.0\text{mH}$ ,  $R_G=25\Omega$ .
3. Pulse test

THIS PRODUCT IS AN ELECTROSTATIC SENSITIVE, PLEASE HANDLE WITH CAUTION.

THIS PRODUCT HAS BEEN QUALIFIED FOR CONSUMER MARKET. APPLICATIONS OR USES AS CRITICAL COMPONENT IN LIFE SUPPORT DEVICE OR SYSTEM ARE NOT AUTHORIZED.

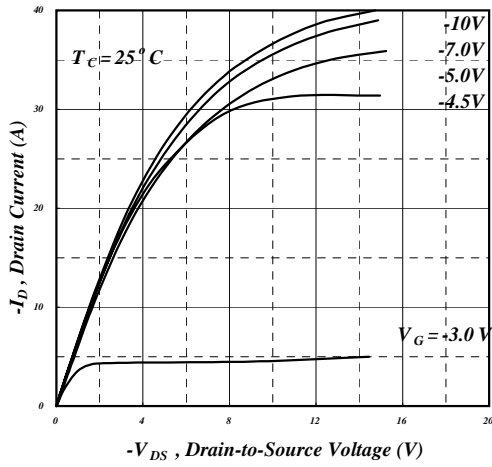

Fig 1. Typical Output Characteristics

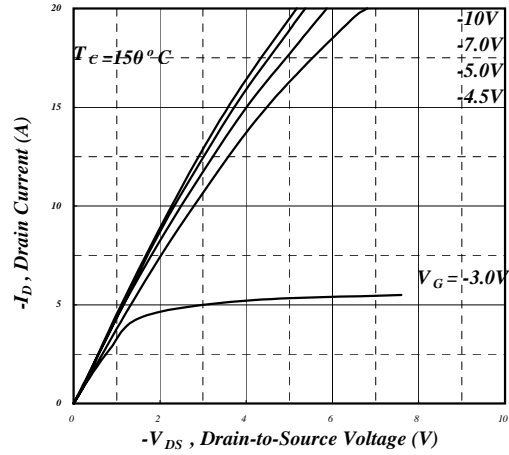

Fig 2. Typical Output Characteristics

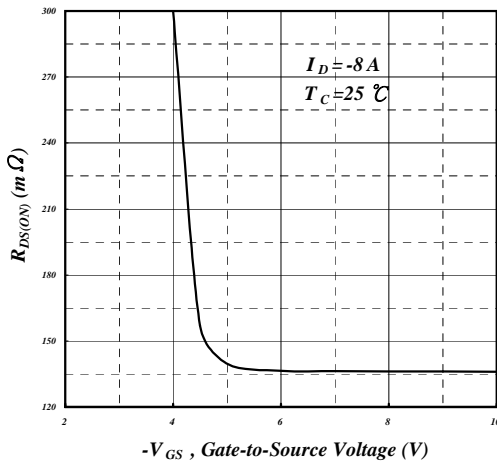

Fig 3. On-Resistance v.s. Gate Voltage

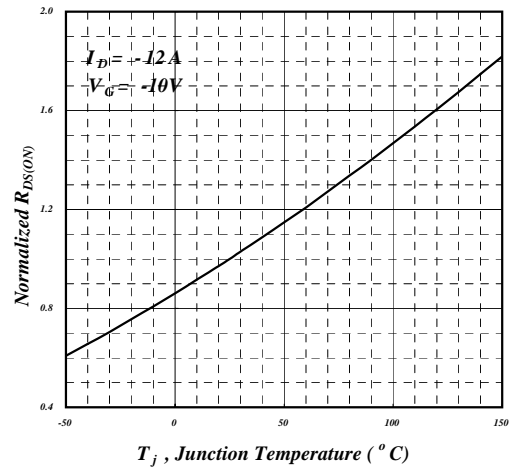

Fig 4. Normalized On-Resistance v.s. Junction Temperature

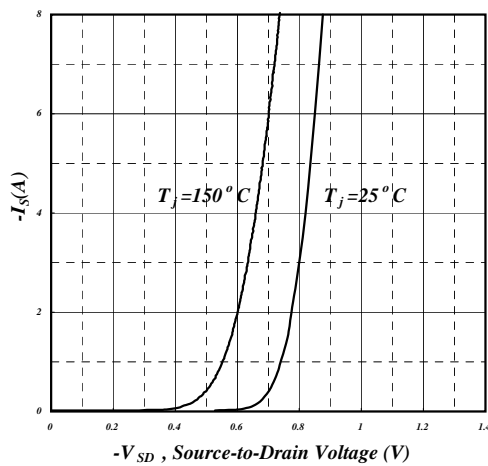

Fig 5. Forward Characteristic of Reverse Diode

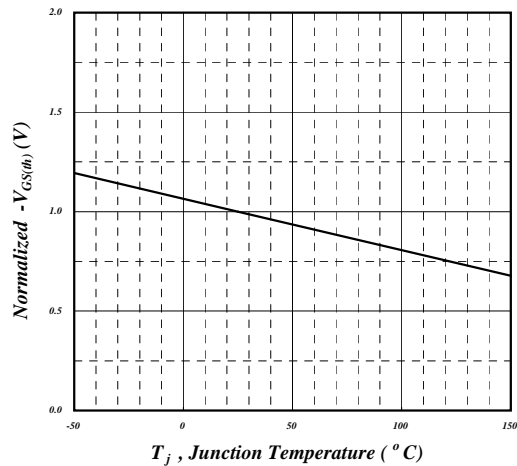

Fig 6. Gate Threshold Voltage v.s. Junction Temperature

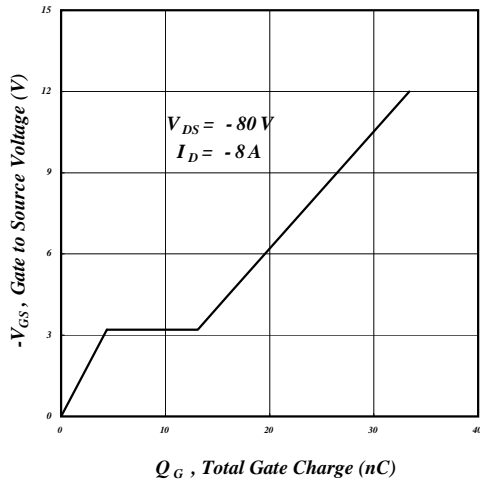

Fig 7. Gate Charge Characteristics

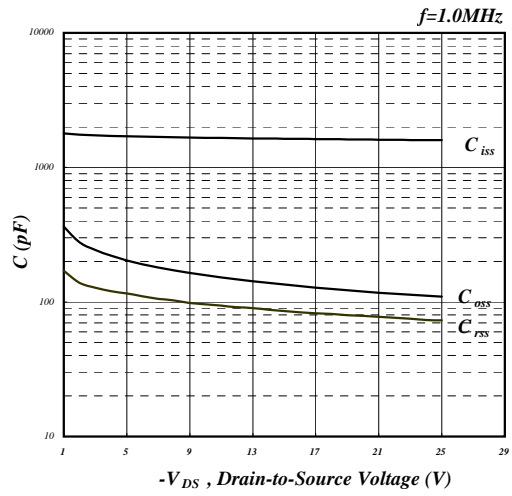

Fig 8. Typical Capacitance Characteristics

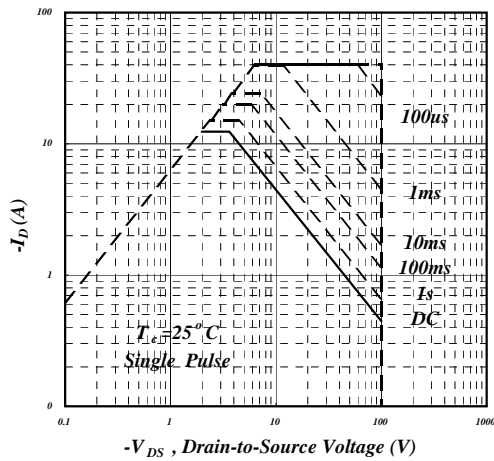

Fig 9. Maximum Safe Operating Area

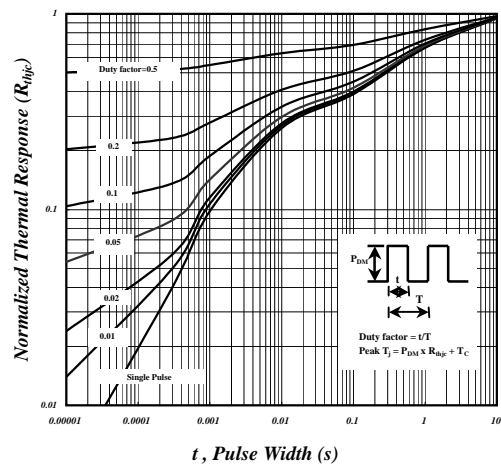

Fig 10. Effective Transient Thermal Impedance

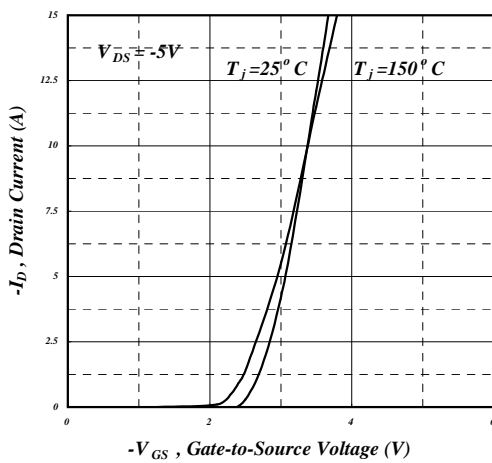

Fig 11. Transfer Characteristics

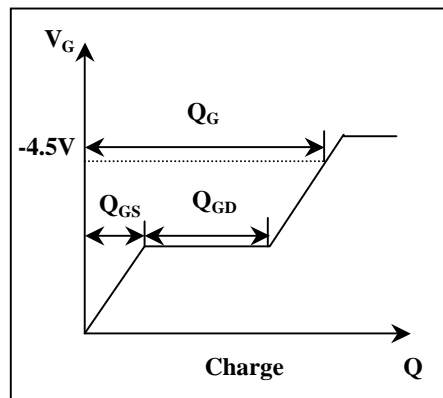
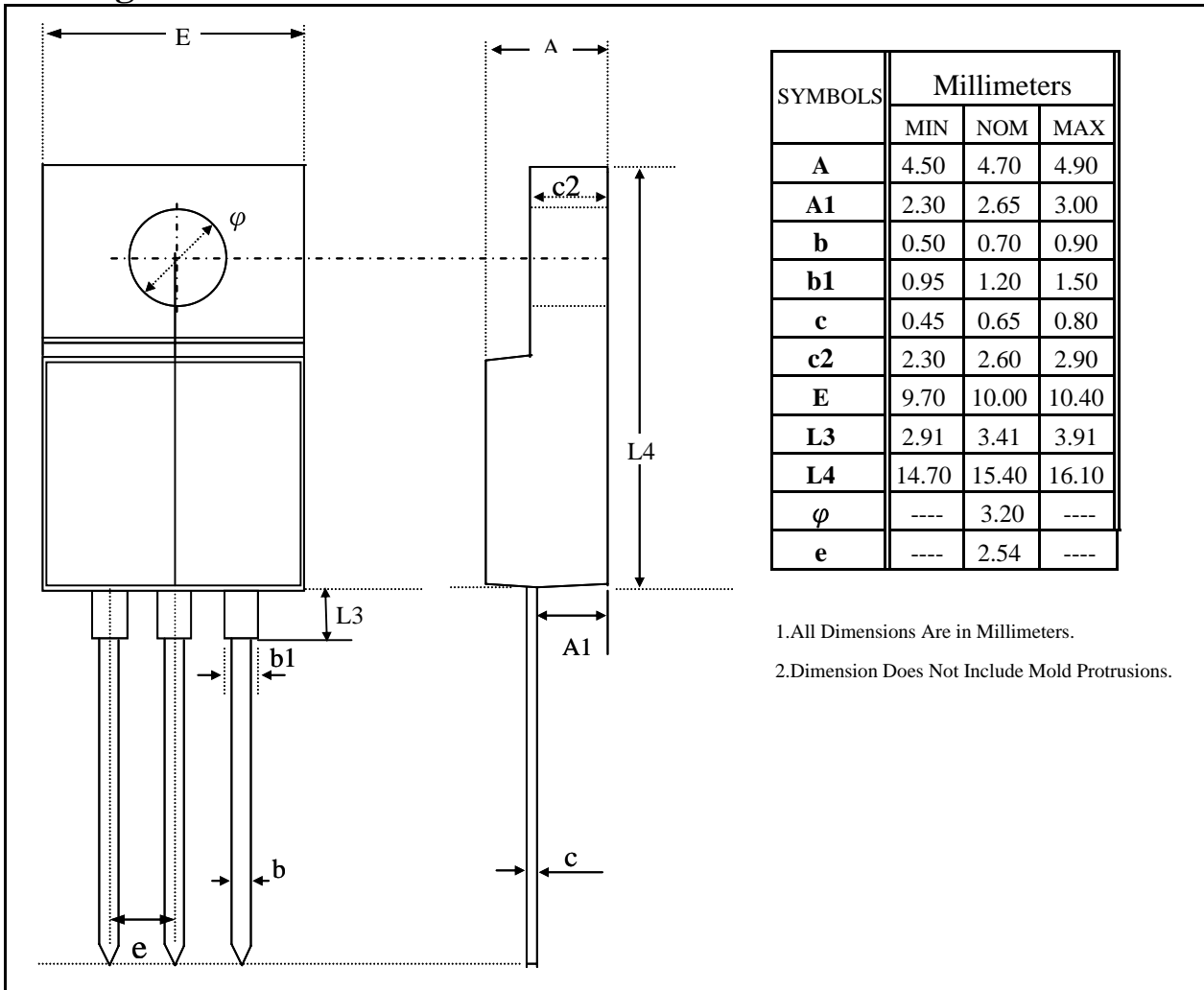

Fig 12. Gate Charge Waveform



## Package Outline : TO-220CFM



## Part Marking Information & Packing : TO-220CFM

