

Hi-Rel 40 V, 0.8 A NPN transistor

Datasheet - production data

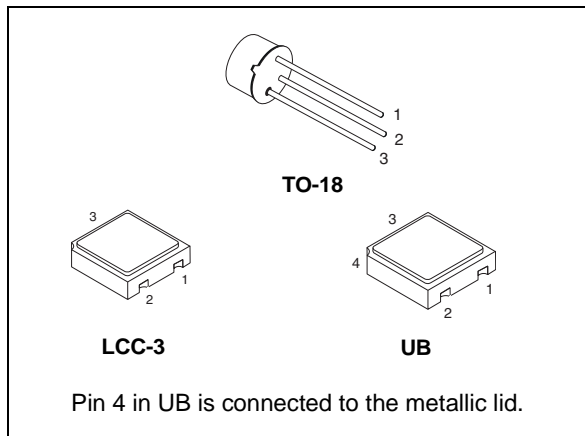
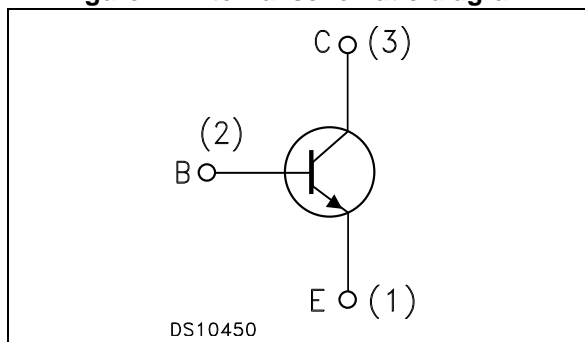

Figure 1. Internal schematic diagram



Features

Parameter	ESCC	JANS
$BV_{CEO \text{ min}}$	40 V	50 V
$I_C \text{ (max)}$	0.8 A	
$h_{FE} \text{ at } 10 \text{ V} - 150 \text{ mA}$	100	

- Hermetic packages
- ESCC and JANS qualified
- Up to 100 krad(Si) low dose rate

Description

The 2N2222AHR is a silicon planar NPN transistor specifically designed and housed in hermetic packages for aerospace and Hi-Rel applications. It is available in the JAN qualification system (MIL-PRF19500 compliance) and in the ESCC qualification system (ESCC 5000 compliance). In case of discrepancies between this datasheet and the relevant agency specification, the latter takes precedence.

Table 1. Device summary

Device	Qualification system	Agency specification	Package	Radiation level	EPPL
JANSR2N2222AUBx	JANSR	MIL-PRF-19500/255	UB	100 krad high and low dose rate	-
JANS2N2222AUBx	JANS	MIL-PRF-19500/255	UB	-	-
2N2222ARUBx	ESCC Flight	5201/002	UB	100 krad - low dose rate	Target
2N2222AUBx	ESCC Flight	5201/002	UB	-	Target
SOC2222ARHRx	ESCC Flight	5201/002	LCC-3	100 krad - low dose rate	Yes
SOC2222AHRx	ESCC Flight	5201/002	LCC-3	-	Yes
2N2222ARHRx	ESCC Flight	5201/002	TO-18	100 krad - low dose rate	Target
2N2222AHRx	ESCC Flight	5201/002	TO-18	-	-

Contents

1	Electrical ratings	3
2	Electrical characteristics	4
2.1	JANS electrical characteristics	4
2.2	ESCC electrical characteristics	5
2.3	Electrical characteristics (curves)	6
2.4	Test circuits	7
3	Radiation hardness assurance	9
4	Package mechanical data	12
4.1	UB	13
4.2	LCC-3	15
4.3	TO-18	17
5	Order codes	18
6	Shipping details	20
6.1	Date code	20
6.2	Documentation	20
7	Revision history	21

1 Electrical ratings

Table 2. Absolute maximum ratings

Symbol	Parameter	Value	Unit
V_{CBO}	Collector-base voltage ($I_E = 0$)	75	V
V_{CEO}	Collector-emitter voltage ($I_B = 0$) for JANS devices	50	V
	Collector-emitter voltage ($I_B = 0$) for ESCC devices	40	V
V_{EBO}	Emitter-base voltage ($I_C = 0$)	6	V
I_C	Collector current	0.8	A
P_{TOT}	Total dissipation at $T_{amb} \leq 25\text{ °C}$ ESCC: TO-18	0.5	W
	LCC-3 and UB	0.5	
	LCC-3 and UB ⁽¹⁾	0.73	
	JANS: LCC-3UB	0.5	
P_{TOT}	Total dissipation at $T_{case} \leq 25\text{ °C}$ ESCC: TO-18	1.8	W
	Total dissipation at $T_{sp(IS)} = 25\text{ °C}$ JANS: UB	1	
T_{STG}	Storage temperature	-65 to 200	°C
T_J	Max. operating junction temperature	200	°C

1. When mounted on a 15 x 15 x 0.6 mm ceramic substrate.

Table 3. Thermal data

Symbol	Parameter	LCC-3 and UB	TO-18	Unit
R_{thJC}	Thermal resistance junction-case (max) for JANS	-	-	°C/W
	Thermal resistance junction-case (max) for ESCC	-	97	
$R_{thJSP(IS)}$	Thermal resistance junction-solder pad (infinite sink) (max) for JANS	90	-	
	Thermal resistance junction-solder pad (infinite sink) (max) for ESCC	-	-	
R_{thJA}	Thermal resistance junction-ambient (max) for JANS	325	-	
	Thermal resistance junction-ambient (max) for ESCC	350 240 ⁽¹⁾	350	

1. When mounted on a 15 x 15 x 0.6 mm ceramic substrate.

2 Electrical characteristics

JANS and ESCC version of the products are assembled and tested in compliance with the agency specification it is qualified in. The electrical characteristics of each version are provided in dedicated tables.

$T_{case} = 25\text{ °C}$ unless otherwise specified.

2.1 JANS electrical characteristics

Table 4. JANS electrical characteristics

Symbol	Parameter	Test conditions	Min.	Typ.	Max.	Unit
I_{CBO}	Collector cut-off current ($I_E = 0$)	$V_{CB} = 75\text{ V}$ $V_{CB} = 60\text{ V}$ $V_{CB} = 60\text{ V}$ $T_{amb} = 150\text{ °C}$		-	10 10 10	μA nA μA
I_{CES}	Collector cut-off current ($I_E = 0$)	$V_{CE} = 50\text{ V}$		-	50	nA
I_{EBO}	Emitter cut-off current ($I_C = 0$)	$V_{EB} = 6\text{ V}$ $V_{EB} = 4\text{ V}$		-	10 10	μA nA
$V_{(BR)CEO}^{(1)}$	Collector-emitter breakdown voltage ($I_B = 0$)	$I_C = 10\text{ mA}$	50	-		V
$V_{CE(sat)}^{(1)}$	Collector-emitter saturation voltage	$I_C = 150\text{ mA}$ $I_B = 15\text{ mA}$ $I_C = 500\text{ mA}$ $I_B = 50\text{ mA}$		-	0.3 1	V V
$V_{BE(sat)}^{(1)}$	Base-emitter saturation voltage	$I_C = 150\text{ mA}$ $I_B = 15\text{ mA}$ $I_C = 500\text{ mA}$ $I_B = 50\text{ mA}$	0.6		1.2 2	V V
$h_{FE}^{(1)}$	DC current gain	$I_C = 0.1\text{ mA}$ $V_{CE} = 10\text{ V}$ $I_C = 1\text{ mA}$ $V_{CE} = 10\text{ V}$ $I_C = 10\text{ mA}$ $V_{CE} = 10\text{ V}$ $I_C = 150\text{ mA}$ $V_{CE} = 10\text{ V}$ $I_C = 500\text{ mA}$ $V_{CE} = 10\text{ V}$ $I_C = 10\text{ mA}$ $V_{CE} = 10\text{ V}$ $T_{amb} = -55\text{ °C}$	50 75 100 100 30 35	-	325 300	
h_{fe}	Small signal current gain	$V_{CE} = 20\text{ V}$ $I_C = 20\text{ mA}$ $f = 100\text{ MHz}$ $V_{CE} = 10\text{ V}$ $I_C = 1\text{ mA}$ $f = 1\text{ kHz}$	2.5 50	-		
C_{obo}	Output capacitance ($I_E = 0$)	$V_{CB} = 10\text{ V}$ 100 kHz E f E 1 MHz		-	8	pF
C_{ibo}	Output capacitance ($I_E = 0$)	$V_{EB} = 0.5\text{ V}$ 100 kHz E f E 1 MHz		-	25	pF

Table 4. JANS electrical characteristics (continued)

Symbol	Parameter	Test conditions	Min.	Typ.	Max.	Unit
t_{on}	Turn-on time	$V_{CC} = 30\text{ V}$ $I_C = 150\text{ mA}$ $I_{B1} = 15\text{ mA}$		-	35	ns
t_{off}	Turn-off time	$V_{CC} = 30\text{ V}$ $I_C = 150\text{ mA}$ $I_{B1} = -I_{B2} = 15\text{ mA}$		-	300	ns

1. Pulsed duration = 300 μs , duty cycle $\leq 2\%$

2.2 ESCC electrical characteristics

Table 5. ESCC electrical characteristics

Symbol	Parameter	Test conditions	Min.	Typ.	Max.	Unit
I_{CBO}	Collector cut-off current ($I_E = 0$)	$V_{CB} = 60\text{ V}$ $V_{CB} = 60\text{ V}$ $T_{amb} = 150\text{ }^\circ\text{C}$		-	10 10	nA μA
I_{EBO}	Emitter cut-off current ($I_C = 0$)	$V_{EB} = 3\text{ V}$		-	10	nA
$V_{(BR)CBO}$	Collector-base breakdown voltage ($I_E = 0$)	$I_C = 100\text{ }\mu\text{A}$	75	-		V
$V_{(BR)CEO}^{(1)}$	Collector-emitter breakdown voltage ($I_B = 0$)	$I_C = 30\text{ mA}$	40	-		V
$V_{(BR)EBO}$	Emitter-base breakdown voltage ($I_C = 0$)	$I_E = 100\text{ }\mu\text{A}$	6	-		V
$V_{CE(sat)}^{(1)}$	Collector-emitter saturation voltage	$I_C = 150\text{ mA}$ $I_B = 15\text{ mA}$		-	0.3	V
$V_{BE(sat)}^{(1)}$	Base-emitter saturation voltage	$I_C = 150\text{ mA}$ $I_B = 15\text{ mA}$		0.87	1.2	V
$h_{FE}^{(1)}$	DC current gain	$I_C = 0.1\text{ mA}$ $V_{CE} = 10\text{ V}$ $I_C = 10\text{ mA}$ $V_{CE} = 10\text{ V}$ $I_C = 150\text{ mA}$ $V_{CE} = 10\text{ V}$ $I_C = 500\text{ mA}$ $V_{CE} = 10\text{ V}$ $I_C = 10\text{ mA}$ $V_{CE} = 10\text{ V}$ $T_{amb} = -55\text{ }^\circ\text{C}$	35 75 100 40 35	-	300	
h_{fe}	Small signal current gain	$V_{CE} = 20\text{ V}$ $I_C = 20\text{ mA}$ $f = 100\text{ MHz}$	3	-	10	
C_{obo}	Output capacitance ($I_E = 0$)	$V_{CB} = 10\text{ V}$ 100 kHz $\leq f \leq 1\text{ MHz}$		-	8	pF

Table 5. ESCC electrical characteristics (continued)

Symbol	Parameter	Test conditions	Min.	Typ.	Max.	Unit
t_{on}	Turn-on time	$V_{CC} = 30\text{ V}$ $I_C = 150\text{ mA}$ $I_{B1} = 15\text{ mA}$		-	35	ns
t_{off}	Turn-off time	$V_{CC} = 30\text{ V}$ $I_C = 150\text{ mA}$ $I_{B1} = -I_{B2} = 15\text{ mA}$		-	285	ns

1. Pulsed duration = 300 μs , duty cycle $\leq 2\%$

2.3 Electrical characteristics (curves)

Figure 2. Safe operating area for LCC-3 and UB

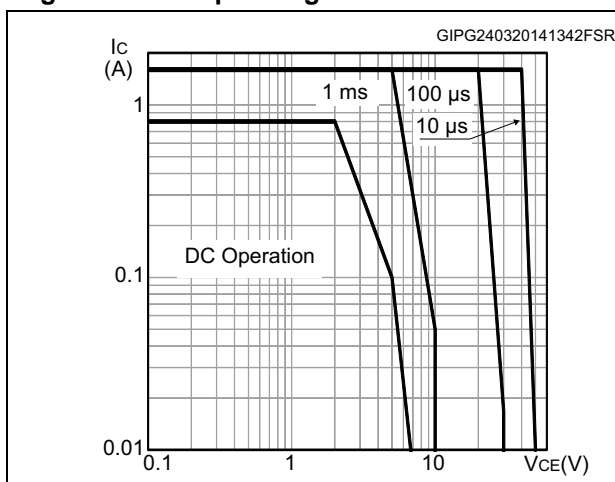

Figure 3. Safe operating area for TO-18

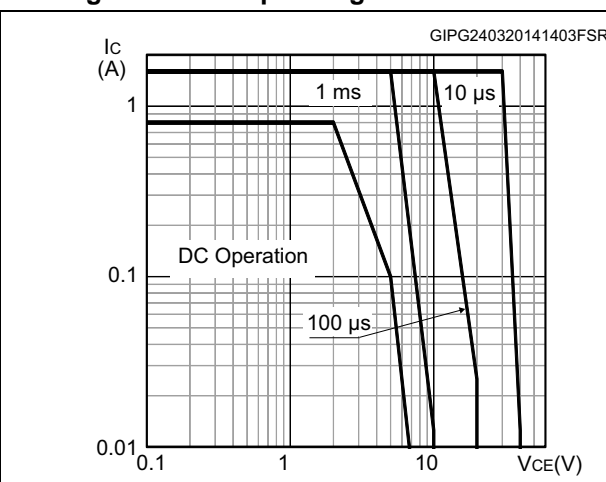

Figure 4. DC current gain

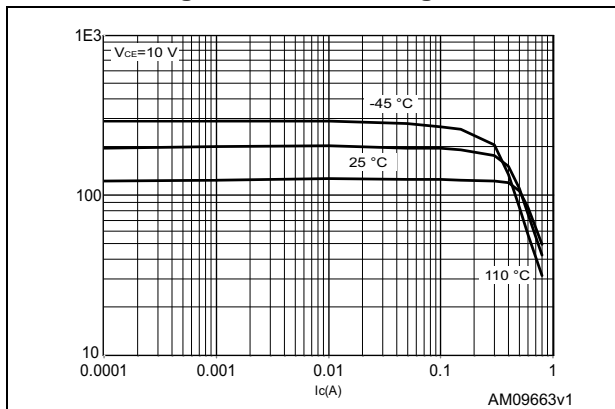

Figure 5. Collector emitter saturation voltage

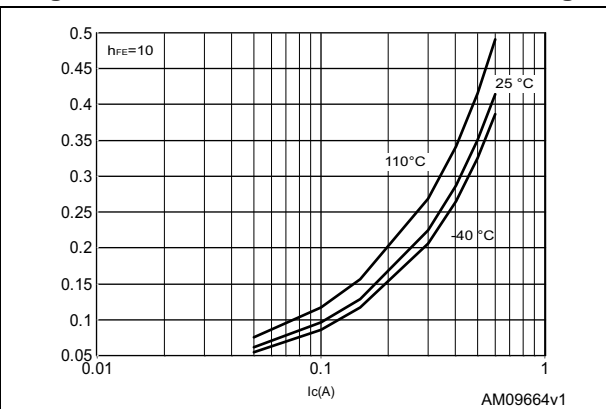
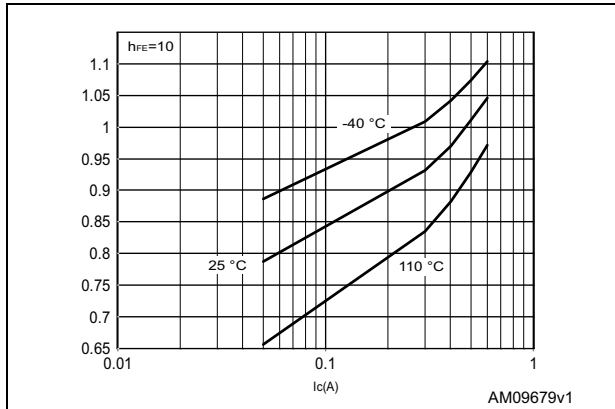

Figure 6. Base emitter saturation voltage



2.4 Test circuits

Figure 7. JANS saturated turn-on switching time test circuit

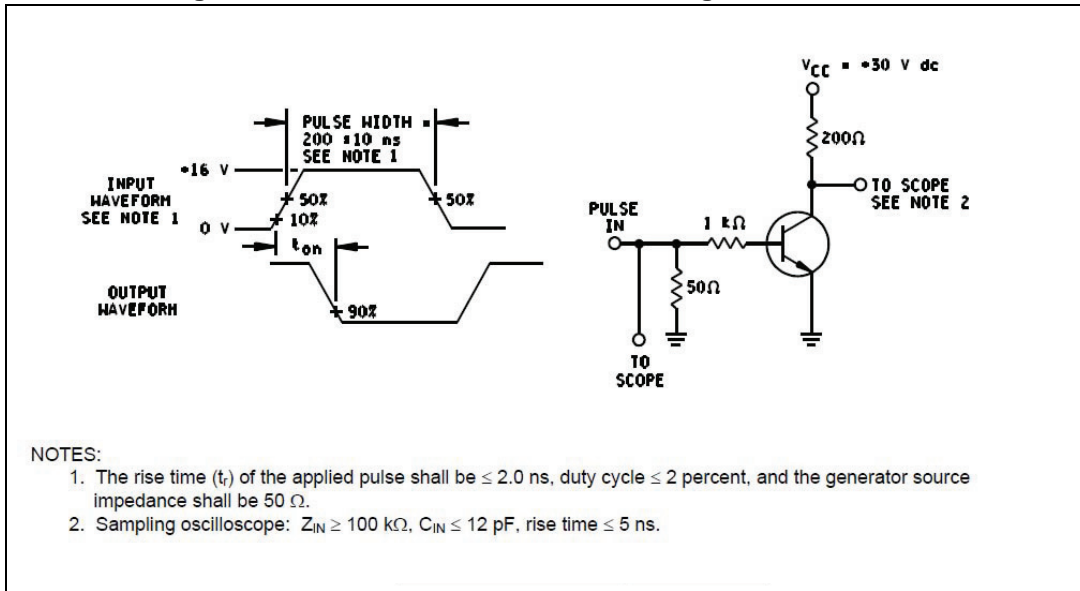

Figure 8. JANS saturated turn-off switching time test circuit

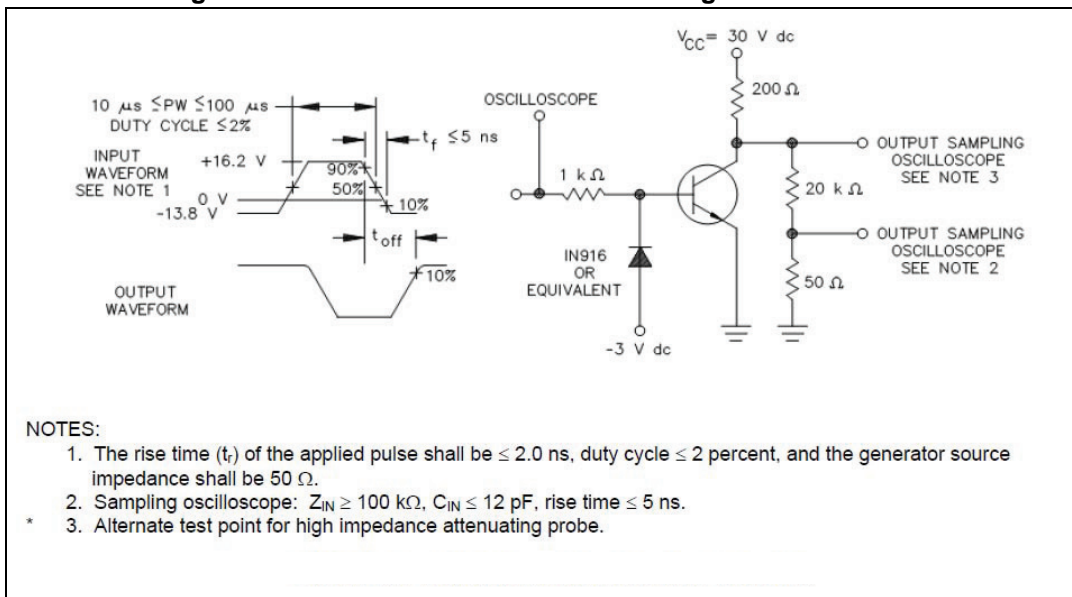
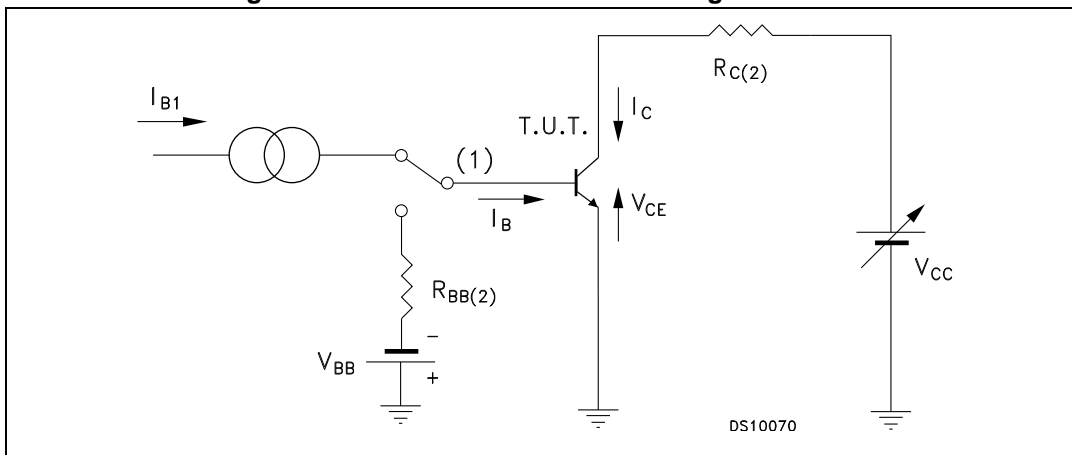

Figure 9. ESCC resistive load switching test circuit



1. Fast electronic switch
2. Non-inductive resistor

3 Radiation hardness assurance

The products guaranteed in radiation within the JANS system fully comply with the MIL-PRF-19500/255 specification.

The products guaranteed in radiation within the ESCC system fully comply with the ESCC 5201/002 and ESCC 22900 specifications.

JANS radiation assurance

ST JANS parts guaranteed at 100 krad (Si), tested, in full compliancy with the MIL-PRF-19500 specification, specifically the Group D, subgroup 2 inspection, between 50 and 300 rad/s. On top of the standard JANSR high dose rate by wafer lot guarantee, ST 2N2222AHR series include an additional wafer by wafer 100 krad Low dose rate guarantee at 0.1 rad/s, identical to the ESCC 100 krad guarantee. It is supported with the same Radiation Verification Test report provided with each shipment. A brief summary of the standard High Dose Rate by wafer lot JANSR guarantee is provided below:

- All test are performed in accordance to MIL-PRF-19500 and test method 1019 of MIL-STD-750 for total Ionizing dose.
- The table below provides for each monitored parameters of the test conditions and the acceptance criteria

Table 6. MIL-PRF-19500 (test method 1019) post radiation electrical characteristics

Symbol	Parameter	Test conditions	Value		Unit
			Min.	Max.	
I_{CBO}	Collector to base cutoff current	$V_{CB} = 75$		20	μA
		$V_{CB} = 60 V$		20	nA
I_{EBO}	Emitter to base cutoff current	$V_{EB} = 6 V$		20	μA
		$V_{EB} = 4 V$		20	nA
$V_{(BR)CEO}$	Breakdown voltage, collector to emitter	$I_C = 10 mA$	50		V
I_{CES}	Collector to emitter cutoff current	$V_{CE} = 50 V$		100	nA
h_{FE}	Forward-current transfer ratio	$V_{CE} = 10 V; I_C = 0.1 mA$	[25] ⁽¹⁾		
		$V_{CE} = 10 V; I_C = 1.0 mA$	[37.5] ⁽¹⁾	325	
		$V_{CE} = 10 V; I_C = 10 mA$	[50] ⁽¹⁾		
		$V_{CE} = 10 V; I_C = 150 mA$	[50] ⁽¹⁾	300	
		$V_{CE} = 10 V; I_C = 500 mA$	[15] ⁽¹⁾		
$V_{CE(sat)}$	Collector-emitter saturation voltage	$I_C = 150 mA; I_B = 15 mA$		0.35	V
		$I_C = 500 mA; I_B = 50 mA$		1.15	
$V_{BE(sat)}$	Base-emitter saturation voltage	$I_C = 150 mA; I_B = 15 mA$	0.6	1.38	V
		$I_C = 500 mA; I_B = 50 mA$		2.3	

1. See method 1019 of MIL-STD-750 for how to determine $[h_{FE}]$ by first calculating the delta ($1/h_{FE}$) from the pre- and Post-radiation h_{FE} . Notice the $[h_{FE}]$ is not the same as h_{FE} and cannot be measured directly. The $[h_{FE}]$ value can never exceed the pre-radiation minimum h_{FE} that it is based upon.

ESCC radiation assurance

Each product lot is tested according to the ESCC basic specification 22900, with a minimum of 11 samples per diffusion lot and 5 samples per wafer, one sample being kept as unirradiated sample, all of them being fully compliant with the applicable ESCC generic and/or detailed specification.

ST goes beyond the ESCC specification by performing the following procedure:

- Test of 11 pieces by wafer, 5 biased at least 80% of $V_{(BR)CEO}$, 5 unbiased and 1 kept for reference
- Irradiation at 0.1 rad (Si)/s
- Acceptance criteria of each individual wafer if as 100 krad guaranteed if all 10 samples comply with the post radiation electrical characteristics provided in [Table 8](#)
- Delivery together with the parts of the radiation verification test (RVT) report of the particular wafer used to manufacture the products. This RVT includes the value of each parameter at 30, 50, 70 and 100 krad (Si) and after 24 hour annealing at room temperature and after an additional 168 hour annealing at 100°C.

Table 7. Radiation summary

Radiation test	100 krad ESCC
Wafer test	each
Part tested	5 biased + 5 unbiased
Dose rate	0.1 rad/s
Acceptance	MIL-STD-750 method 1019
Displacement damage	Optional
Agency part number (ex)	5202/001/02 ⁽¹⁾
ST part number (ex)	SOC2222ARHRG
Documents	CoC + RVT

1. Example of the 2N2222A in LCC-3 gold finish.



Table 8. ESCC 5201/002 post radiation electrical characteristics

Symbol	Parameter	Test conditions	Min.	Typ.	Max.	Unit
I_{CBO}	Collector cut-off current ($I_E = 0$)	$V_{CB} = 60 \text{ V}$		-	10	nA
I_{EBO}	Emitter cut-off current ($I_C = 0$)	$V_{EB} = 3 \text{ V}$		-	10	nA
$V_{(BR)CBO}$	Collector-base breakdown voltage ($I_E = 0$)	$I_C = 100 \mu\text{A}$	75	-		V
$V_{(BR)CEO}^{(1)}$	Collector-emitter breakdown voltage ($I_B = 0$)	$I_C = 30 \text{ mA}$ $I_C = 10 \text{ mA}$	40 50	-		V V
$V_{(BR)EBO}$	Emitter-base breakdown voltage ($I_C = 0$)	$I_E = 100 \mu\text{A}$	6	-		V
$V_{CE(sat)}^{(1)}$	Collector-emitter saturation voltage	$I_C = 150 \text{ mA}$ $I_B = 15 \text{ mA}$		-	0.3	V
$V_{BE(sat)}^{(1)}$	Base-emitter saturation voltage	$I_C = 150 \text{ mA}$ $I_B = 15 \text{ mA}$			1.2	V
$[h_{FE}]^{(1)}$	Post irradiation gain calculation ⁽²⁾	$I_C = 0.1 \text{ mA}$ $V_{CE} = 10 \text{ V}$ $I_C = 10 \text{ mA}$ $V_{CE} = 10 \text{ V}$ $I_C = 150 \text{ mA}$ $V_{CE} = 10 \text{ V}$ $I_C = 500 \text{ mA}$ $V_{CE} = 10 \text{ V}$	[17.5] [37.5] [50] [20]	-	300	

1. Pulsed duration = 300 μs , duty cycle $\leq 2\%$

2. The post-irradiation gain calculation of $[h_{FE}]$, made using h_{FE} measurements from prior to and on completion of irradiation testing and after each annealing step if any, shall be as specified in MILSTD-750 method 1019.

4 Package mechanical data

In order to meet environmental requirements, ST offers these devices in different grades of ECOPACK[®] packages, depending on their level of environmental compliance. ECOPACK[®] specifications, grade definitions and product status are available at: www.st.com. ECOPACK[®] is an ST trademark.

Table 9. Product mass summary

Package	Mass (g)
UB	0.06
LCC-3	0.06
TO-18	0.40

4.1 UB

Figure 10. UB drawings

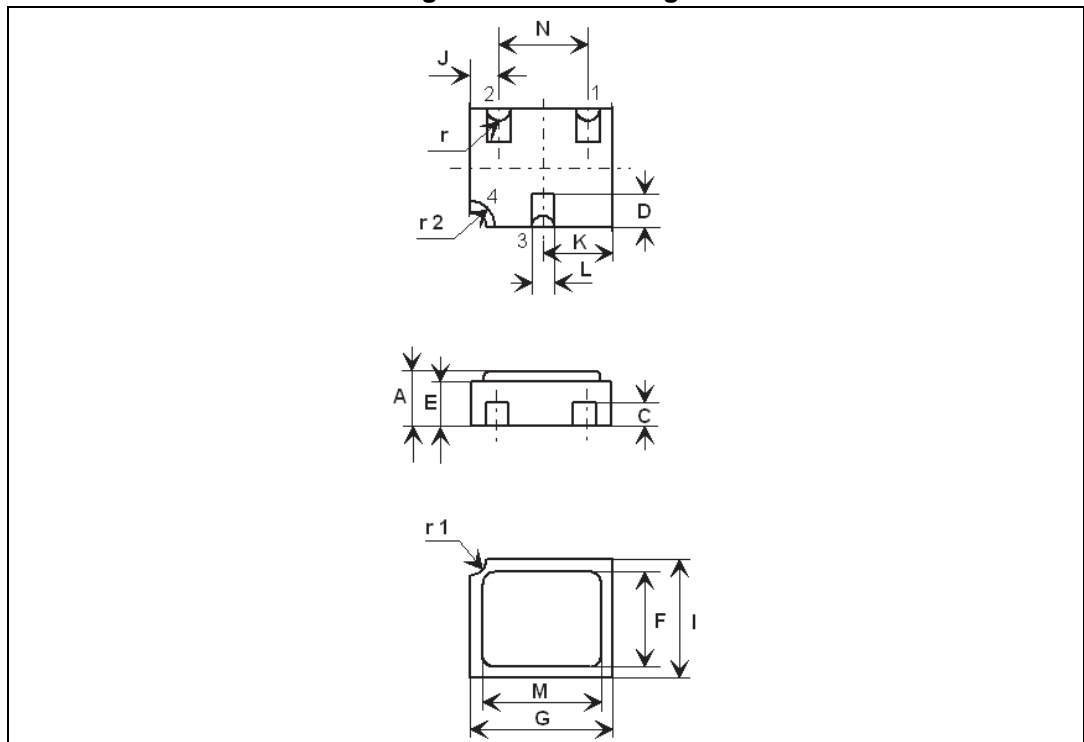

Table 10. UB mechanical data

Dim.	mm.		
	Min.	Typ.	Max.
A	1.16		1.42
C	0.46	0.51	0.56
D	0.56	0.76	0.96
E	0.92	1.02	1.12
F	1.95	2.03	2.11
G	2.92	3.05	3.18
I	2.41	2.54	2.67
J	0.42	0.57	0.72
K	1.37	1.52	1.67
L	0.41	0.51	0.61
M	2.46	2.54	2.62
N	1.81	1.91	2.01
r		0.20	
r1		0.30	
r2		0.56	

4.2 LCC-3

Figure 11. LCC-3 drawings

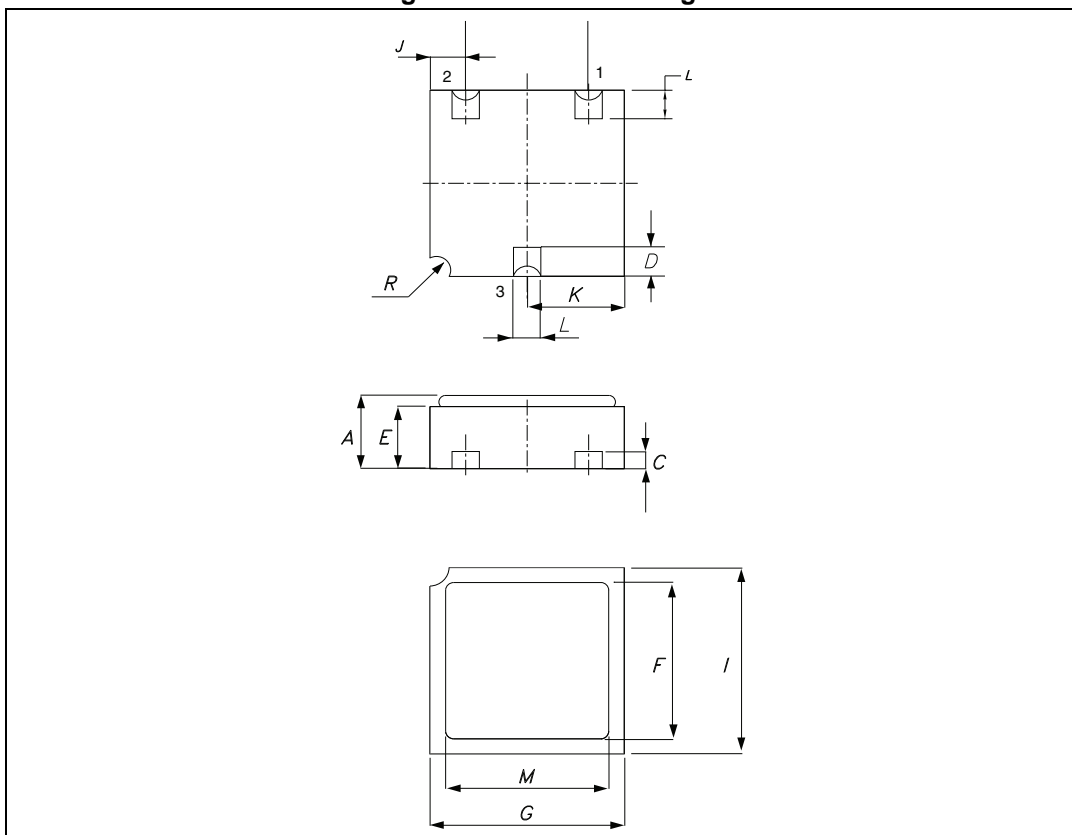

Table 11. LCC-3 mechanical data

Dim.	mm.		
	Min.	Typ.	Max.
A	1.16		1.42
C	0.45	0.50	0.56
D	0.60	0.76	0.91
E	0.91	1.01	1.12
F	1.95	2.03	2.11
G	2.92	3.05	3.17
I	2.41	2.54	2.66
J	0.42	0.57	0.72
K	1.37	1.52	1.67
L	0.40	0.50	0.60
M	2.46	2.54	2.62
N	1.80	1.90	2.00
R		0.30	

4.3 TO-18

Figure 12. TO-18 drawings

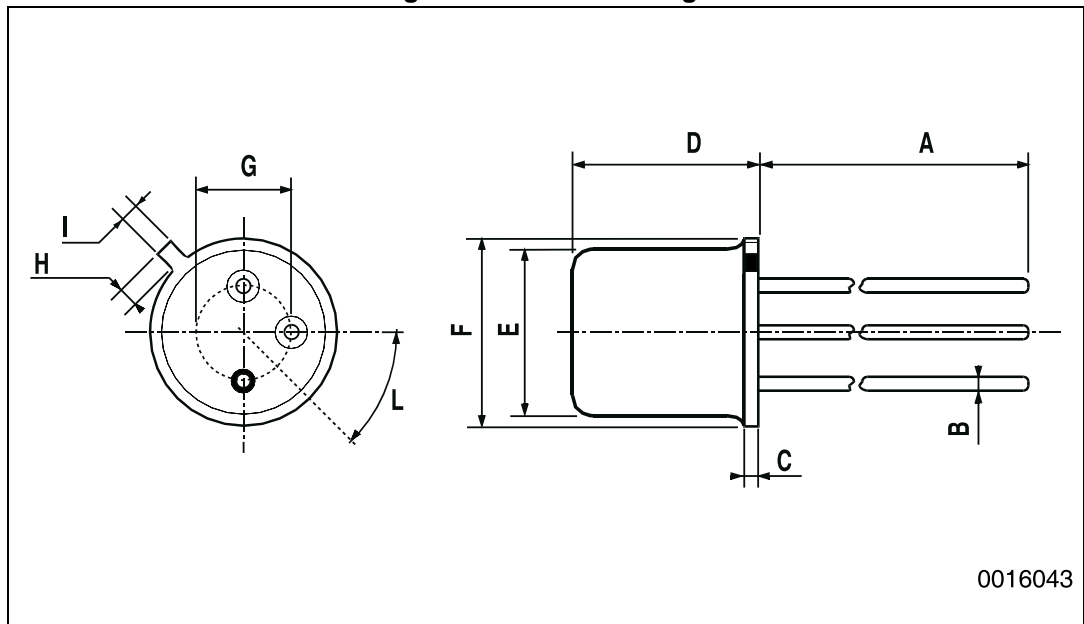

Table 12. TO-18 mechanical data

Dim.	mm.		
	Min.	Typ.	Max.
A		12.7	
B			0.49
D			5.3
E			4.9
F			5.8
G	2.54		
H			1.2
I			1.16
L	45°		

5 Order codes

Table 13. Ordering information

CPN	Agency specification	EPPL	Quality level	Radiation level ⁽¹⁾	Package	Lead finish	Marking ⁽²⁾	Packing
J2N2222AUB1	-	-	Engineering model JANS	-	UB	Gold	J2222AUB1	WafflePack
2N2222AUB1	-	-	Engineering model ESCC	-	UB	Gold	2N2222AUB1	WafflePack
SOC2222A1	-	-	Engineering model ESCC	-	LCC-3	Gold	SOC2222A1	WafflePack
JANSR2N2222AUBG	MIL-PRF-19500/255	-	JANSR	100 krad high and low dose rate	UB	Gold	JSR2222	WafflePack
JANSR2N2222AUBT	MIL-PRF-19500/255	-	JANSR	100 krad high and low dose rate	UB	Solder Dip	JSR2222	WafflePack
JANS2N2222AUBG	MIL-PRF-19500/255	-	JANS	-	UB	Gold	JS2222	WafflePack
JANS2N2222AUBT	MIL-PRF-19500/255	-	JANS	-	UB	Solder Dip	JS2222	WafflePack
2N2222ARUBG	5201/002/11R	Target	ESCC Flight	100 krad - low dose rate	UB	Gold	520100211R	WafflePack
2N2222ARUBT	5201/002/12R	Target	ESCC Flight	100 krad - low dose rate	UB	Solder Dip	520100212R	WafflePack
2N2222AUBG	5201/002/11	Target	ESCC Flight	-	UB	Gold	520100211	WafflePack
2N2222AUBT	5201/002/12	Target	ESCC Flight	-	UB	Solder Dip	520100212	WafflePack
SOC2222ARHRG	5201/002/04R	Yes	ESCC Flight	100 krad - low dose rate	LCC-3	Gold	520100204R	WafflePack
SOC2222ARHRT	5201/002/05R	Yes	ESCC Flight	100 krad - low dose rate	LCC-3	Solder Dip	520100205R	WafflePack
SOC2222AHRG	5201/002/04	Yes	ESCC Flight	-	LCC-3	Gold	520100204	WafflePack
SOC2222AHRT	5201/002/05	Yes	ESCC Flight	-	LCC-3	Solder Dip	520100205	WafflePack
2N2222ARHRG	5201/002/01R	Target	ESCC Flight	100 krad - low dose rate	TO-18	Gold	520100201R	Strip Pack
2N2222ARHRT	5201/002/02R	Target	ESCC Flight	100 krad - low dose rate	TO-18	Solder Dip	520100202R	Strip Pack



Table 13. Ordering information (continued)

CPN	Agency specification	EPPL	Quality level	Radiation level ⁽¹⁾	Package	Lead finish	Marking ⁽²⁾	Packing
2N2222AHRG	5201/002/01	-	ESCC Flight	-	TO-18	Gold	520100201	Strip Pack
2N2222AHRT	5201/002/02	-	ESCC Flight	-	TO-18	Solder Dip	520100202	Strip Pack

1. High dose rate as per MIL-PRF-19500 specification group D, subgroup 2 inspection. Low dose rate as per ESCC specification 22900.
2. Specific marking only. The full marking includes in addition: For the Engineering Models: ST logo, date code; country of origin (FR). For ESCC flight parts: ST logo, date code, country of origin (FR), ESA logo, serial number of the part within the assembly lot. For JANS flight parts: ST logo, date code, country of origin (FR), manufacturer code (CSTM), serial number of the part within the assembly lot.

Contact ST sales office for information about the specific conditions for:

- Products in die form
- Other JANS quality levels
- Tape and reel packing

6 Shipping details

6.1 Date code

Date code xyywwz is structured as below table:

Table 14. Date code

	x	yy	ww	z
EM (ESCC & JANS)	3	last two digits of the year	week digits	lot index in the week
ESCC FLIGHT	-			
JANS FLIGHT (diffused in Singapore)	W			

6.2 Documentation

Table 15. Documentation provided for each type of product

Quality level	Radiation level	Documentation
Engineering model	-	-
JANS Flight	-	Certificate of conformance
JANSR Flight	MIL-STD 100krad	Certificate of conformance 50 rad/s radiation verification test report
	ST 100Krad	Certificate of conformance 0.1 rad/s radiation verification test report on each wafer
ESCC Flight	-	Certificate of conformance
	100 krad	Certificate of conformance 0.1 rad/s radiation verification test report

7 Revision history

Table 16. Document revision history

Date	Revision	Changes
04-Jan-2010	1	Initial release
16-Apr-2010	2	Added Table 1 on page 1
09-Jul-2010	3	Modified: Table 1 on page 1 and Table 12 on page 17
30-Nov-2011	4	<ul style="list-style-type: none"> – Modified: Table 5 on page 5 – Added: Section 2.3: Electrical characteristics (curves) – Modified: Table 1 and 2 – Added: Table 2, 11, 12 – Minor text changes in the document title and description on the cover page.
12-Dec-2011	5	Minor text changes to improve readability
17-Apr-2012	6	<p>Updated:</p> <ul style="list-style-type: none"> – Title and description in cover page. – P_{TOT} in Table 2: Absolute maximum ratings. – The entire Section 2: Electrical characteristics. <p>Added:</p> <ul style="list-style-type: none"> – Table 3: Thermal data, Section 3: Radiation hardness assurance and Table 13: Ordering information. – Figure 7: JANS saturated turn-on switching time test circuit and Figure 8: JANS saturated turn-off switching time test circuit. – Section 6: Shipping details.
19-Apr-2012	7	Updated titles in Figure 7: JANS saturated turn-on switching time test circuit and Figure 8: JANS saturated turn-off switching time test circuit .
24-Apr-2012	8	Updated R_{thJA} value in Table 3: Thermal data .
14-May-2012	9	Updated Table 13: Ordering information .
21-Feb-2013	10	<p>Table 1: Device summary and Table 13: Ordering information have been updated.</p> <p>Updated text in Section 3: Radiation hardness assurance.</p>
04-Apr-2013	11	Inserted Table 7: Radiation summary
06-Jun-2013	12	Updated package name for UB.
18-Sep-2013	13	Table 1: Device summary and Table 13: Ordering information have been updated.
25-Mar-2014	14	<p>Table 1: Device summary and Table 13: Ordering information have been updated.</p> <p>Updated Section 3: Radiation hardness assurance and Section 4: Package mechanical data</p> <p>Inserted Figure 2: Safe operating area for LCC-3 and UB and Figure 3: Safe operating area for TO-18</p>

Table 16. Document revision history (continued)

Date	Revision	Changes
01-Apr-2014	15	Modified note in package silhouette on cover page.
29-May-2014	16	Updated Table 1: Device summary and Table 13: Ordering information .
17-Feb-2015	17	Updated Table 1.: Device summary Minor text changes.
27-Feb-2015	18	Minor text changes
05-May-2015	19	Updated Table 1.: Device summary Minor text changes.

IMPORTANT NOTICE – PLEASE READ CAREFULLY

STMicroelectronics NV and its subsidiaries ("ST") reserve the right to make changes, corrections, enhancements, modifications, and improvements to ST products and/or to this document at any time without notice. Purchasers should obtain the latest relevant information on ST products before placing orders. ST products are sold pursuant to ST's terms and conditions of sale in place at the time of order acknowledgement.

Purchasers are solely responsible for the choice, selection, and use of ST products and ST assumes no liability for application assistance or the design of Purchasers' products.

No license, express or implied, to any intellectual property right is granted by ST herein.

Resale of ST products with provisions different from the information set forth herein shall void any warranty granted by ST for such product.

ST and the ST logo are trademarks of ST. All other product or service names are the property of their respective owners.

Information in this document supersedes and replaces information previously supplied in any prior versions of this document.

© 2015 STMicroelectronics – All rights reserved

Mouser Electronics

Authorized Distributor

Click to View Pricing, Inventory, Delivery & Lifecycle Information:

[STMicroelectronics:](#)

[2N2222A](#) [2N2222](#)