



Spec. No.	PS-ND-08090304
Rev.	A

PRODUCT SPECIFICATION

Model No : CSM-88138A9/88148A9

Descriptions:

- 1.85 Inch 8X8 Dot-Matrix Display
- Dot Pitch 6.0mm
- CSM-88138: Column Anode, Row Cathode
- CSM-88148: Column Cathode, Row Anode
- Emitting Color: Super Bright Amber



CUSTOMER APPROVED SIGNATURES	APPROVED BY	CHECKED BY	PREPARED BY

CHINA SEMICONDUCTOR CORPORATION

Address:2FL. NO.909,Chung-Cheng Road,
Chung-Ho City Taipei Hsien,Taiwan.

Tel:886-2-2223-9696
Fax:886-2-2223-9377

OPTO PLUS TECHNOLOGIES CO.,LTD

Address:696 Shun jiang Rd.,Ji Shan St.Shaoxing,
ZheJiang,China

Tel:86-0575-88623888
Fax:86-0575-88623112



Spec. No.	PS-ND-08090304
Rev.	A

Model No : CSM-88138A9/88148A9

■ Features -

1. 1.85 inch (47.0mm) Matrix height.
2. 8x8 array with X-Y select.
3. RoHS compliant.
4. Low power consumption.
5. Easy mounting on P.C. board or socket.

■ Device Selection Guide -

Part No.	Chip		Description	
	Material	Emitted Color	Column	Row
CSM-88138A9	GaAsP	Super Bright Amber	Anode	Cathode
CSM-88148A9	GaAsP	Super Bright Amber	Cathode	Anode

■ Package Dimensions -

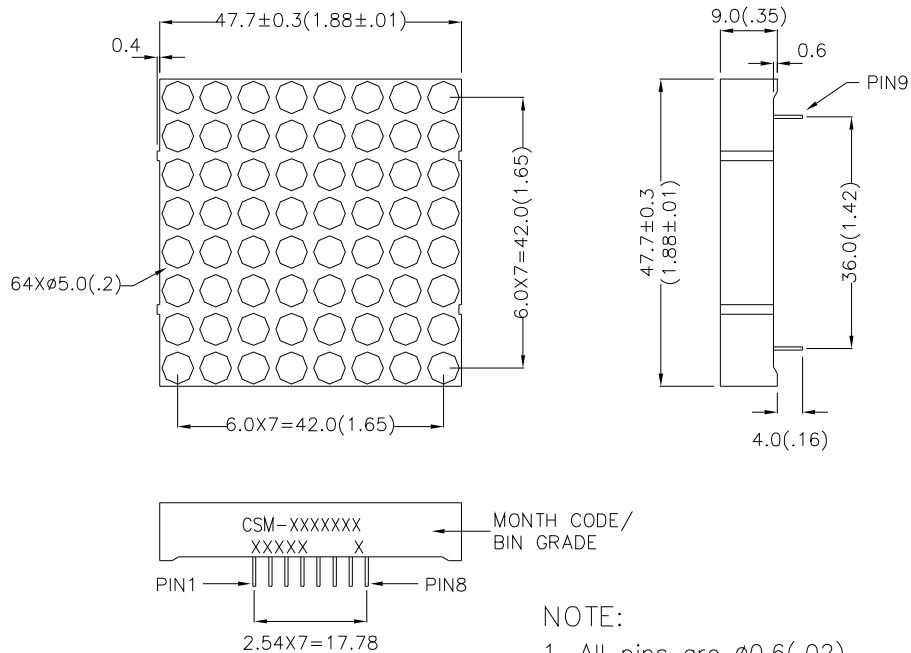

NOTE:

1. All pins are $\phi 0.6$ (.02).
2. Dimensions in millimeters (inch), tolerance is ± 0.25 (.01) unless otherwise noted.



Model No : CSM-88138A9/88148A9

Internal Circuit Diagrams -

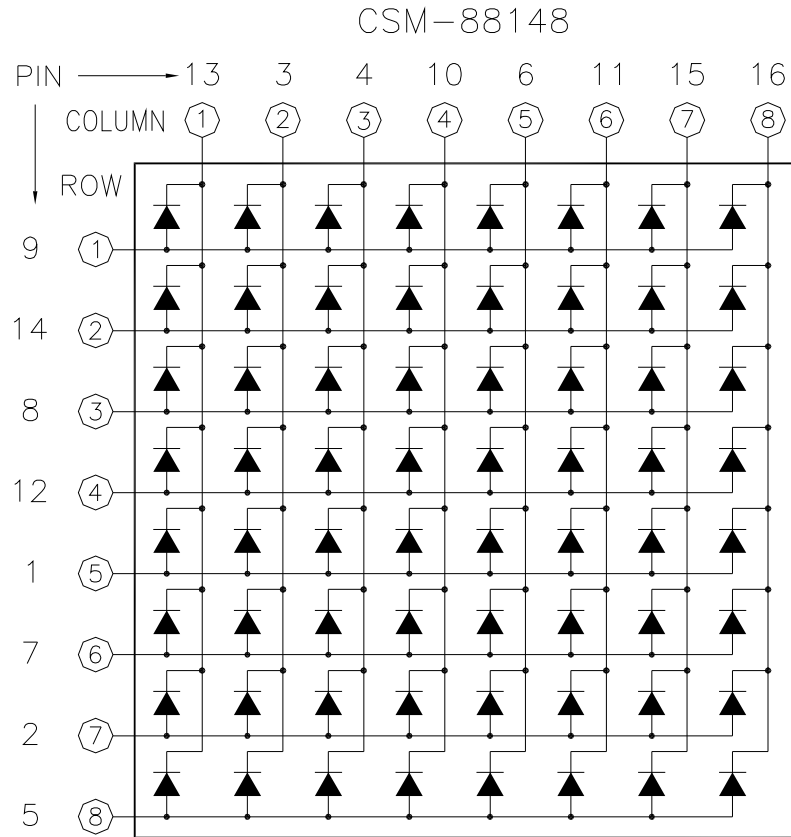

CSM-88138				CSM-88148			
PIN NO.	FUNCTION	PIN NO.	FUNCTION	PIN NO.	FUNCTION	PIN NO.	FUNCTION
1	Cathode Row 5	9	Cathode Row 1	1	Anode Row 5	9	Anode Row 1
2	Cathode Row 7	10	Anode Column 4	2	Anode Row 7	10	Cathode Column 4
3	Anode Column 2	11	Anode Column 6	3	Cathode Column 2	11	Cathode Column 6
4	Anode Column 3	12	Cathode Row 4	4	Cathode Column 3	12	Anode Row 4
5	Cathode Row 8	13	Anode Column 1	5	Anode Row 8	13	Cathode Column 1
6	Anode Column 5	14	Cathode Row 2	6	Cathode Column 5	14	Anode Row 2
7	Cathode Row 6	15	Anode Column 7	7	Anode Row 6	15	Cathode Column 7
8	Cathode Row 3	16	Anode Column 8	8	Anode Row 3	16	Cathode Column 8



Model No : CSM-88138A9/88148A9

■ Absolute Maximum Rating -

(Ta=25°C)

Parameter	Symbol	Rating	Unit
Power Dissipation Per Dice	P _{AD}	70	mW
Continuous Forward Current Per Dice	I _{AF}	25	mA
Peak Current Per Dice(duty cycle 1/10,1KHz)	I _{PF}	90	mA
Derating Linear From 25°C Per Dice	-	0.33	mA/°C
Reverse Voltage Per Dice	V _R	5	V
Operating Temp.	T _{opr}	-35 ~ +85	°C
Storage Temp.	T _{stg}	-35 ~ +85	°C
Solder temperature 1/16 inch below seating plane for 3 seconds at 260°C			

■ Electro-optical Characteristics -

(Ta=25°C)

Parameter	Symbol	Min.	Typ.	Max.	Unit	Condition
Forward Voltage Per Dot	V _F	-	2.0	2.8	V	I _F =20mA
Luminous Intensity Per Dot	I _v	-	45	-	mcd	I _F =10mA
Peak Emission Wavelength	λ _p	-	612	-	nm	I _F =20mA
Dominant Wavelength	λ _d	-	606	-	nm	I _F =20mA
Spectrum Radiation Bandwidth	Δλ	-	20	-	nm	I _F =20mA
Reverse Current	I _R	-	-	100	μA	V _R =5V
Luminous Intensity Matching Ratio	I _{V-m}	-	-	2:1	-	I _p =80mA 1/16Duty



Spec. No.	PS-ND-08090304
Rev.	A

Model No : CSM-88138A9/88148A9

■ Typical Electrical / Optical Characteristics Curves -

(Ta = 25°C Unless Otherwise Noted)

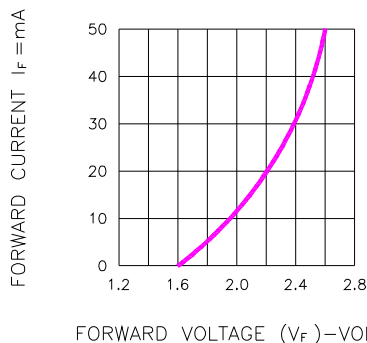

Fig.1 FORWARD CURRENT VS. FORWARD VOLTAGE

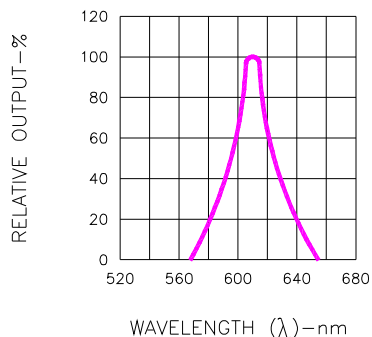

Fig.2 SPECTRAL RESPONSE

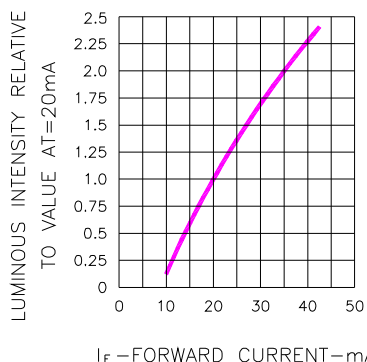

Fig.3 RELATIVE LUMINOUS INTENSITY VS. FORWARD CURRENT

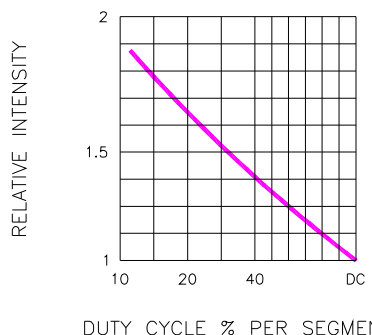

Fig.5 LUMINOUS INTENSITY VS. DUTY CYCLE

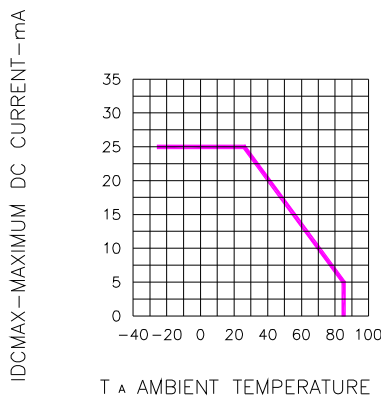

Fig.4 MAXIMUM ALLOWABLE DC CURRENT PER SEGMENT VS. A FUNCTION OF AMBIENT

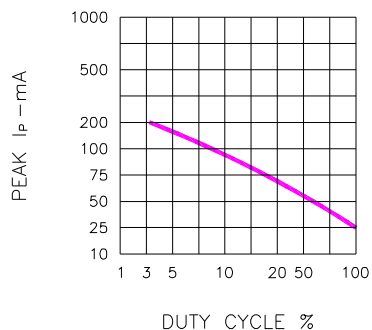

Fig.6 MAX PEAK CURRENT VS. DUTY CYCLE % (REFRESH RATE f=1 KHz)



Spec. No.	PS-ND-08090304
Rev.	A

Model No : CSM-88138A9/88148A9

■ Package Dimensions

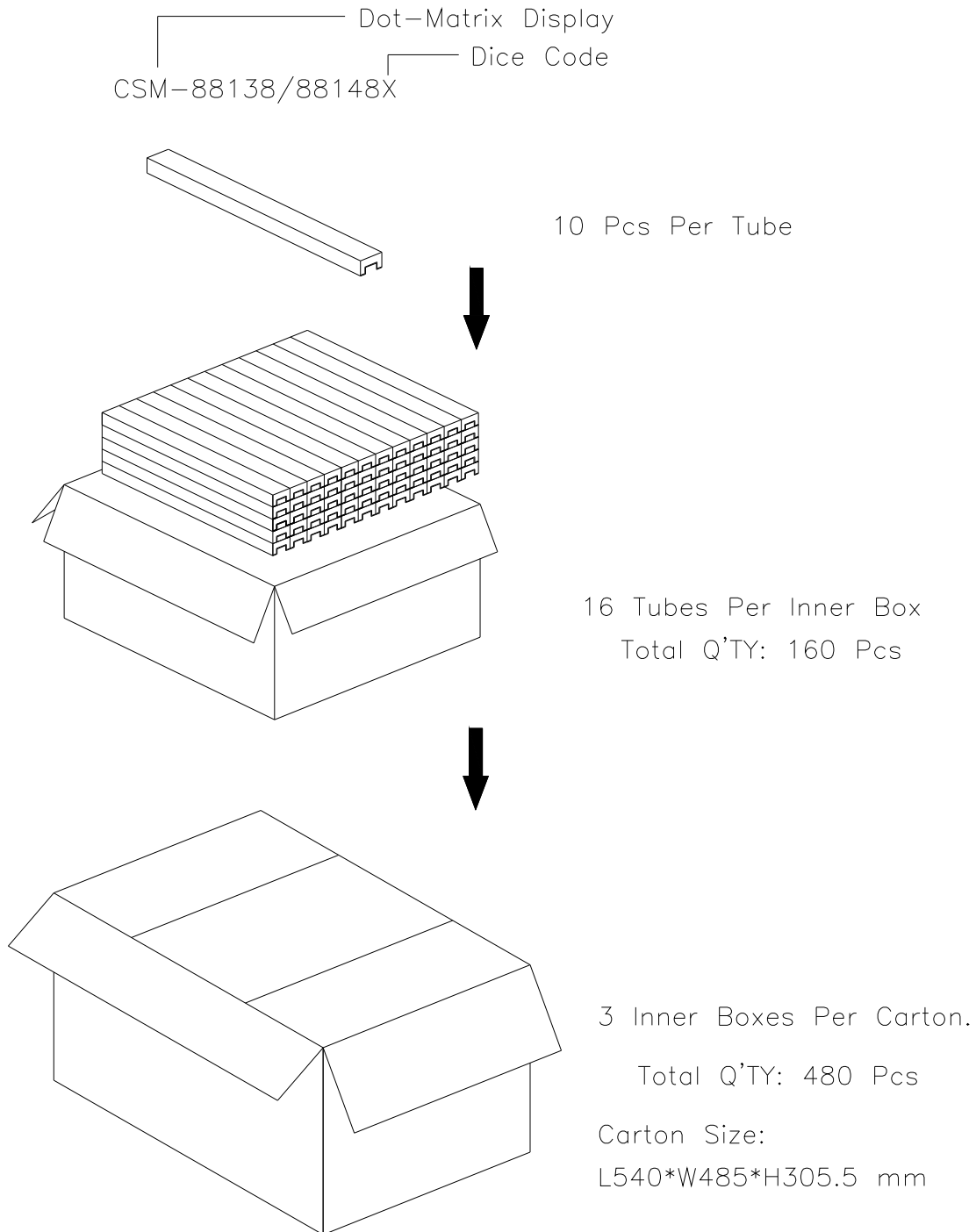

Note: The specifications are subject to change without notice. Please contact us for updated information.