

Ultrafast Rectifier

Features

- Ultrafast Recovery Time
- Low Forward Voltage Drop
- Low Leakage Current
- 175°C Operating Junction Temperature

$t_{rr} = 60ns$
$I_{F(AV)} = 30Amp$
$V_R = 400V$

Description/ Applications

International Rectifier's FRED.. series are the state of the art Ultra fast recovery rectifiers specifically designed with optimized performance of forward voltage drop and ultra fast recovery time.

The planar structure and the platinum doped life time control, guarantee the best overall performance, ruggedness and reliability characteristics.

These devices are intended for use in the output rectification stage of SMPS, UPS, DC-DC converters as well as free-wheeling diode in low voltage inverters and chopper motor drives.

Their extremely optimized stored charge and low recovery current minimize the switching losses and reduce over dissipation in the switching element and snubbers.

Absolute Maximum Ratings

Parameters	Max	Units
V_{RRM} Peak Repetitive Peak Reverse Voltage	400	V
$I_{F(AV)}$ Average Rectified Forward Current	Per Leg 15	A
	Total Device (Rated V_R), $T_C = 149^\circ C$ Total Device 30	
I_{FSM} Non Repetitive Peak Surge Current, @ 25°C	Per Leg 200	
I_{FRM} Peak Repetitive Forward Current	Per Leg 30	
$(Rated V_R, Square wave, 20 KHz), T_C = 149^\circ C$		
T_J, T_{STG} Operating Junction and Storage Temperatures	- 65 to 175	°C

Case Styles

30CPU04

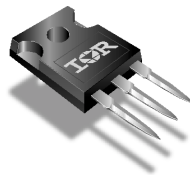

TO247AC

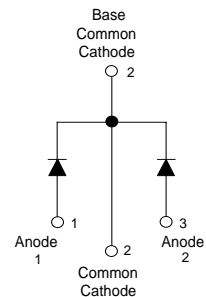

Electrical Characteristics @ T_J = 25°C (unless otherwise specified)

Parameters	Min	Typ	Max	Units	Test Conditions
V _{BR} , V _r Breakdown Voltage, Blocking Voltage	400	-	-	V	I _R = 100μA
V _F Forward Voltage	-	1.17	1.25	V	I _F = 15A
	-	0.93	1.12	V	I _F = 15A, T _J = 150°C
I _R Reverse Leakage Current	-	0.3	10	μA	V _R = V _R Rated
	-	30	500	μA	T _J = 150°C, V _R = V _R Rated
C _T Junction Capacitance	-	28	-	pF	V _R = 400V
L _S Series Inductance	-	12	-	nH	Measured lead to lead 5mm from package body

Dynamic Recovery Characteristics @ T_J = 25°C (unless otherwise specified)

Parameters	Min	Typ	Max	Units	Test Conditions
t _{rr} Reverse Recovery Time	-	36	60	ns	I _F = 1.0A, di _F /dt = 50A/μs, V _R = 30V
	-	46	-		T _J = 25°C
	-	80	-		T _J = 125°C
I _R RRM Peak Recovery Current	-	3.6	-	A	T _J = 25°C
	-	8.7	-		T _J = 125°C
Q _{rr} Reverse Recovery Charge	-	84	-	nC	T _J = 25°C
	-	345	-		T _J = 125°C

I_F = 15A
V_R = 200V
di_F/dt = 200A/μs

Thermal - Mechanical Characteristics

Parameters	Min	Typ	Max	Units
T _J Max. Junction Temperature Range	-	-	175	°C
T _{Stg} Max. Storage Temperature Range	- 65	-	175	
R _{thJC} Thermal Resistance, Junction to Case	-	0.8	1.5	°C/W
R _{thJA} ^① Thermal Resistance, Junction to Ambient	-	-	40	
R _{thCS} ^② Thermal Resistance, Case to Heatsink	-	0.4	-	
Wt Weight	-	6.0	-	g
	-	0.21	-	(oz)
Mounting Torque	6.0	-	12	Kg-cm
	5.0	-	10	lbf.in

① Typical Socket Mount

② Mounting Surface, Flat, Smooth and Greased

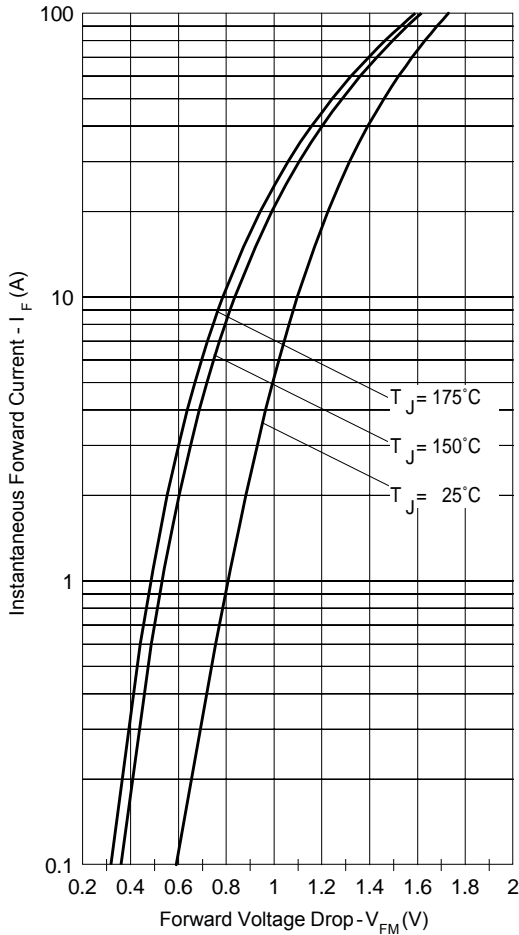

Fig. 1 - Typical Forward Voltage Drop Characteristics

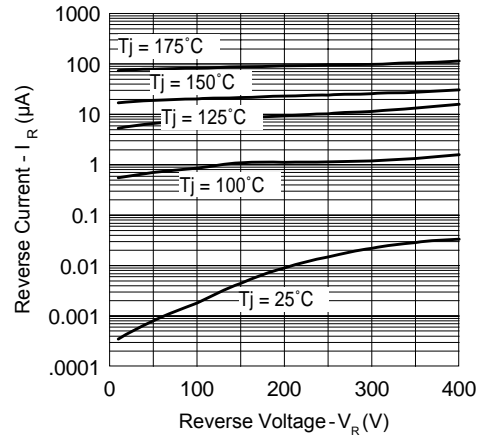

Fig. 2 - Typical Values Of Reverse Current Vs. Reverse Voltage

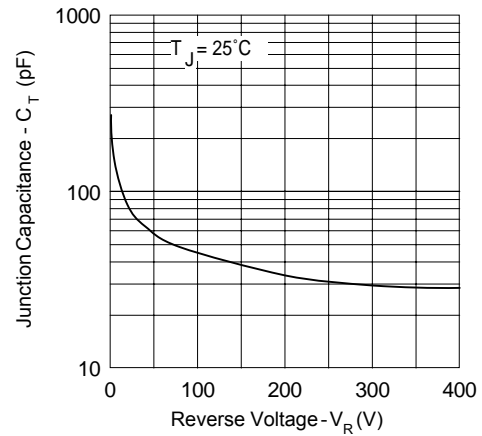

Fig. 3 - Typical Junction Capacitance Vs. Reverse Voltage

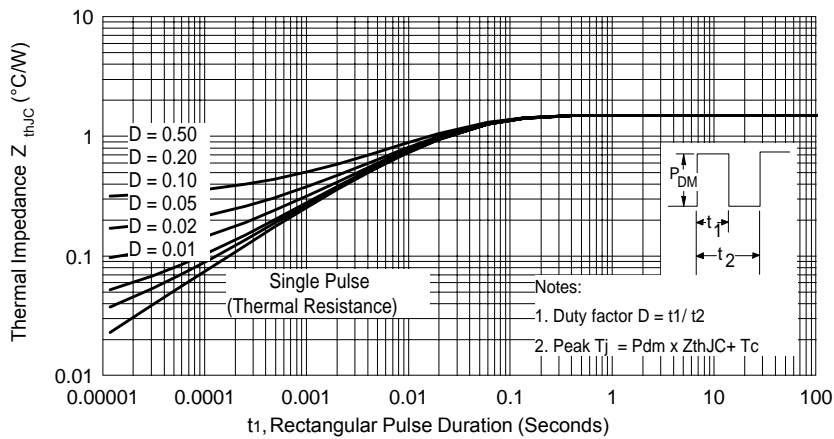

Fig. 4 - Max. Thermal Impedance Z_{thJC} Characteristics

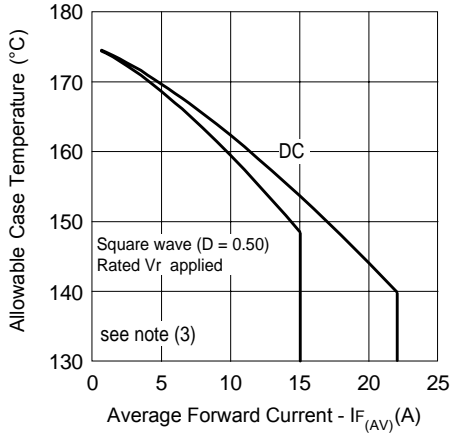

Fig. 5 - Max. Allowable Case Temperature Vs. Average Forward Current

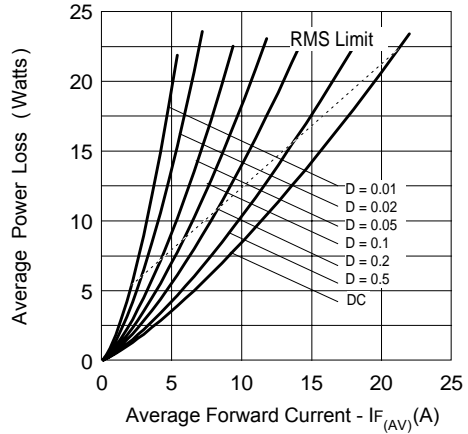

Fig. 6 - Forward Power Loss Characteristics

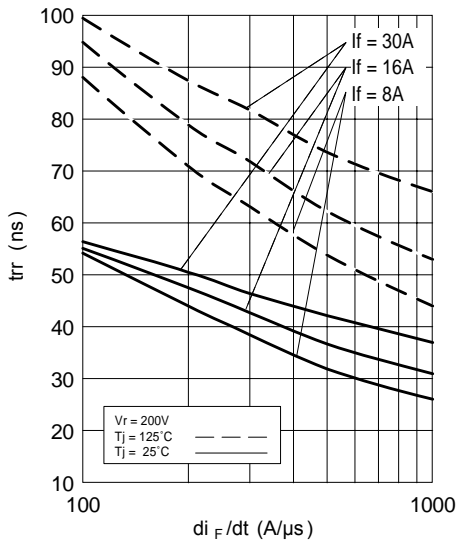

Fig. 7 - Typical Reverse Recovery vs. di_F/dt

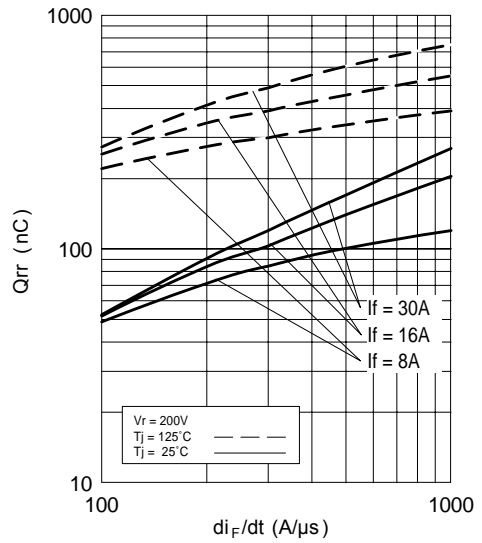

Fig. 8 - Typical Stored Charge vs. di_F/dt

(3) Formula used: $T_c = T_j - (Pd + Pd_{REV}) \times R_{thJC}$;

Pd = Forward Power Loss = $I_{F(AV)} \times V_{FM} @ (I_{F(AV)}/D)$ (see Fig. 6);

Pd_{REV} = Inverse Power Loss = $V_{R1} \times I_R (1-D)$; $I_R @ V_{R1}$ = rated V_R

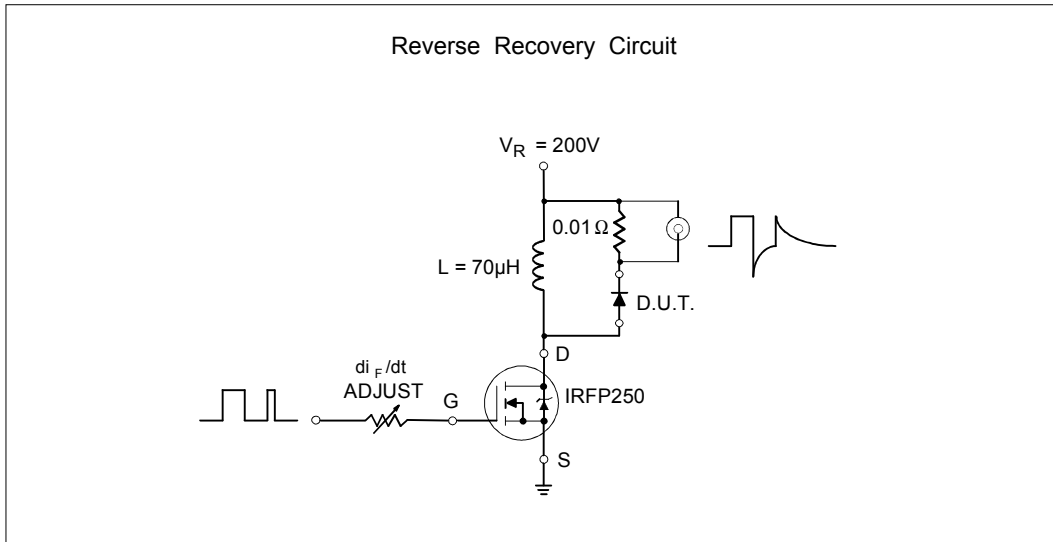

Fig. 9- Reverse Recovery Parameter Test Circuit

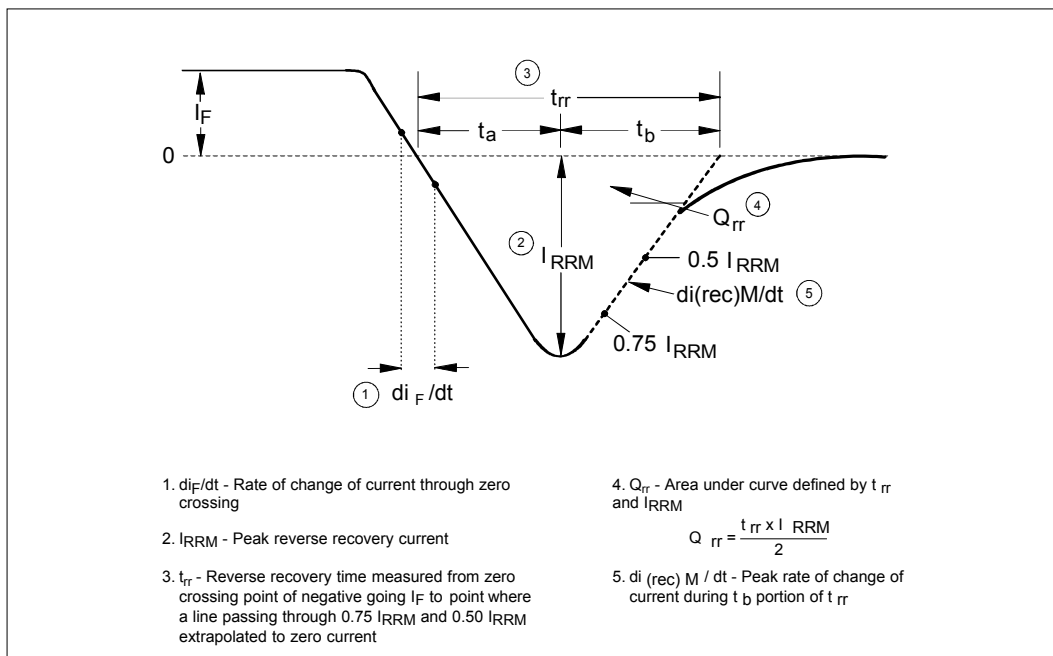
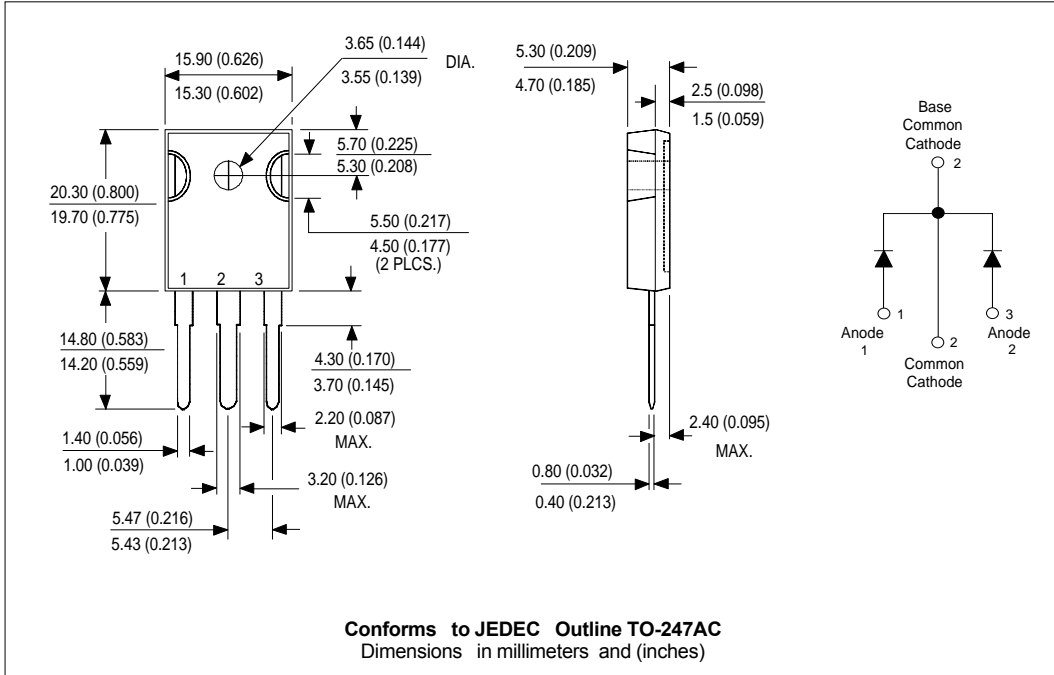

Fig. 10 - Reverse Recovery Waveform and Definitions

Outline Table



Ordering Information Table

Device Code				
30	C	P	U	04
①	②	③	④	⑤
1	-	Current Rating	(30 = 30A)	
2	-	Common Cathode		
3	-	TO-247AC		
4	-	Ultrafast Recovery		
5	-	Voltage Rating	(04 = 400V)	

Data and specifications subject to change without notice.
This product has been designed and qualified for Industrial Level.
Qualification Standards can be found on IR's Web site.

International
IOR Rectifier

IR WORLD HEADQUARTERS: 233 Kansas St., El Segundo, California 90245, USA Tel: (310) 252-7105
TAC Fax: (310) 252-7309
Visit us at www.irf.com for sales contact information. 11/01