

# SRF520 THRU SRF5200 ( SINGLE CHIP)



**SCHOTTKY BARRIER RECTIFIER**  
Reverse Voltage - 20 to 200 Volts  
Forward Current - 5.0 Amperes

## FEATURES

- Plastic package has Underwriters Laboratory Flammability Classification 94V-0
- Metal silicon junction ,majority carrier conduction
- Guard ring for overvoltage protection
- Low power loss ,high efficiency
- High current capability ,Low forward voltage drop
- Single rectifier construction
- High surge capability
- For use in low voltage ,high frequency inverters, free wheeling ,and polarity protection applications
- High temperature soldering guaranteed:260°C/10 seconds, 0.25"(6.35mm)from case
- Component in accordance to RoHS 2002/95/EC and WEEE 2002/96/EC

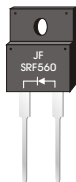

## ITO-220AC

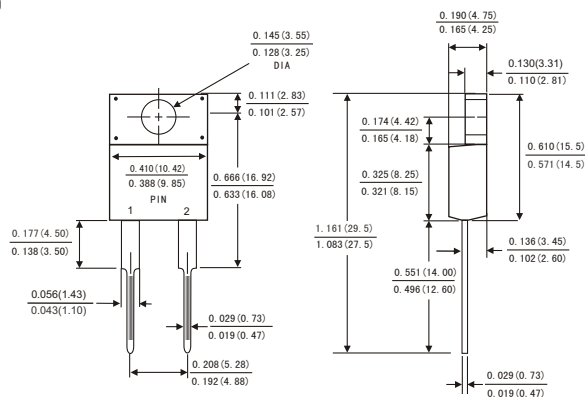

Dimensions in inches and (millimeters)

## MECHANICAL DATA

- Case: JEDEC ITO-220AC molded plastic body
- Terminals: Lead solderable per MIL-STD-750,method 2026
- Polarity: As marked
- Mounting Position: Any
- Weight: 0.08ounce, 2.24 gram

## MAXIMUM RATINGS AND ELECTRICAL CHARACTERISTICS

(Ratings at 25°C ambient temperature unless otherwise specified ,Single phase ,half wave ,resistive or inductive load. For capacitive load,derate by 20%.)

	Symbols	SRF 520	SRF 530	SRF 540	SRF 550	SRF 560	SRF 580	SRF 5A0	SRF 5150	SRF 5200	Units
Maximum repetitive peak reverse voltage	$V_{RRM}$	20	30	40	50	60	80	100	150	200	Volts
Maximum RMS voltage	$V_{RMS}$	14	21	28	35	42	57	71	105	140	Volts
Maximum DC blocking voltage	$V_{DC}$	20	30	40	50	60	80	100	150	200	Volts
Maximum average forward rectified current 0.375"(9.5mm) lead length(see fig.1)	$I(AV)$	5.0									Amps
Peak forward surge current 8.3ms single half sine-wave superimposed on rated load (JEDEC method at rated $T_J$ )	$I_{FSM}$	150.0									Amps
Maximum instantaneous forward voltage at 5.0 A(Note 1)	$V_F$	0.60			0.75		0.85		0.90	0.95	Volts
Maximum instantaneous reverse current at rated DC blocking voltage(Note 1)	$T_A = 25^\circ C$	0.5									mA
	$T_A = 100^\circ C$	50			25						
Typical junction capacitance(Note 3)	$C_J$	500			400						pF
Typical thermal resistance (Note 2)	$R_{\theta JA}$	25.0									°C/W
	$R_{\theta JL}$	8.0									
Operating junction temperature range	$T_J$	-65 to +125				-65 to +150					°C
Storage temperature range	$T_{STG}$	-65 to +150									°C

Notes: 1.Pulse test: 300  $\mu$  s pulse width,1% duty cycle

2.Thermal resistance from junction to lead vertical P.C.B. mounted , 0.375"(9.5mm)lead length

3.Measured at 1MHz and reverse voltage of 4.0volts

# RATINGS AND CHARACTERISTIC CURVES SRF520 THRU SRF5200 (SINGLE CHIP)

FIG.1-FORWARD CURRENT DERATING CURVE

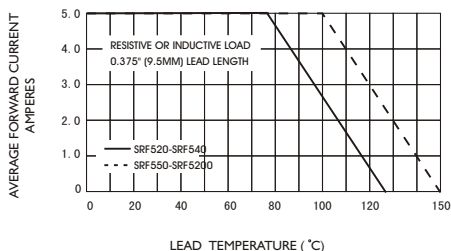

FIG.2-MAXIMUM NON-REPETITIVE PEAK FORWARD SURGE CURRENT

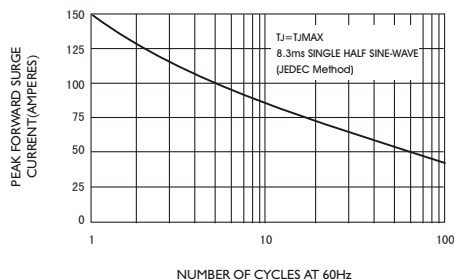

FIG.3-TYPICAL INSTANTANEOUS FORWARD CHARACTERISTICS

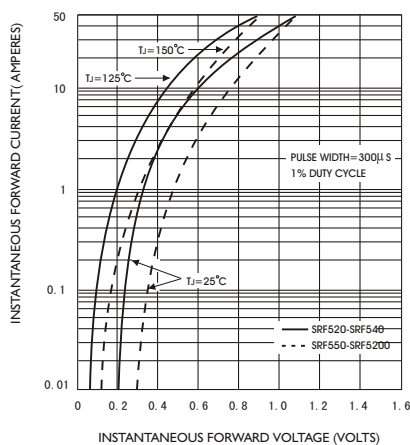

FIG.4-TYPICAL REVERSE CHARACTERISTICS

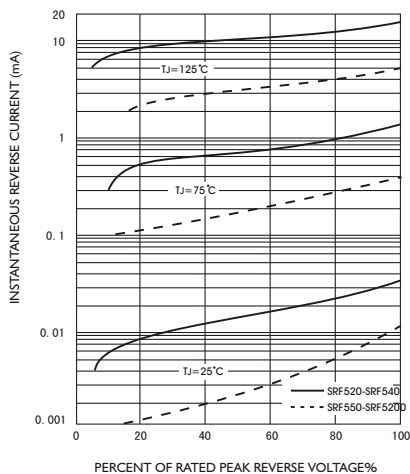

FIG.5-TYPICAL JUNCTION CAPACITANCE

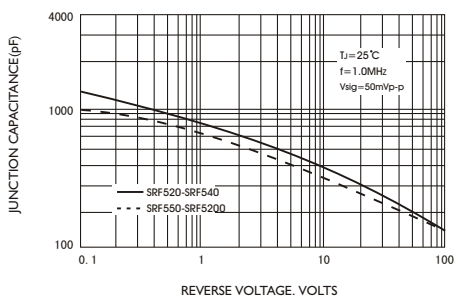

FIG.6-TYPICAL TRANSIENT THERMAL IMPEDANCE

