

Low IR Schottky barrier diode

Features

- Low IR
- Low VF
- Center tap connection

Applications

- High frequency operation
- DC-DC converters
- AC adapter

Outline drawings, mm

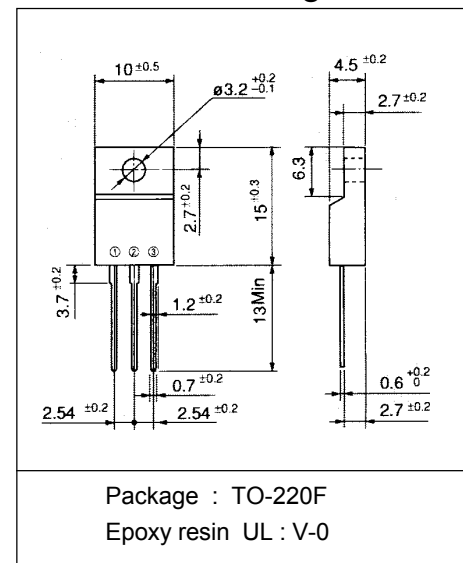

Connection diagram

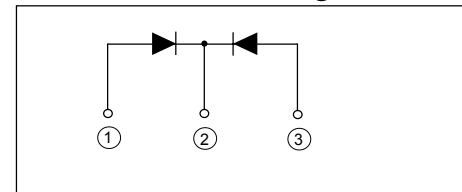

Maximum ratings and characteristics

Maximum ratings

Item	Symbol	Conditions	Rating	Unit
Repetitive peak surge reverse voltage	V_{RSM}	tw=500ns, duty=1/40	60	V
Repetitive peak reverse voltage	V_{RRM}		60	V
Isolating voltage	Viso	Terminals-to-Case, AC. 1min.	1500	V
Average output current	I_o	Square wave, duty=1/2 $T_c=101^\circ\text{C}$	30 *	A
Non-repetitive surge current	I_{FSM}	Sine wave 10ms	160	A
non-repetitive reverse surge power dissipation	PRM	tw=10 μ s, $T_j=25^\circ\text{C}$	750	W
Operating junction temperature	T_j		+150	$^\circ\text{C}$
Storage temperature	T_{stg}		-40 to +150	$^\circ\text{C}$

* Out put current of center tap full wave connection

Electrical characteristics (at $T_a=25^\circ\text{C}$ Unless otherwise specified)

Item	Symbol	Conditions	Max.	Unit
Forward voltage **	V_F	$I_F=15\text{A}$	0.74	V
Reverse current **	I_R	$V_R=60\text{V}$	200	μA
Thermal resistance	$R_{th(j-c)}$	Junction to case	2.0	$^\circ\text{C/W}$

**Rating per element

Mechanical characteristics

Mounting torque	Recommended torque	0.3 to 0.5	N·m
Approximate mass		2	g

■ Characteristics

