

Loose

Taped

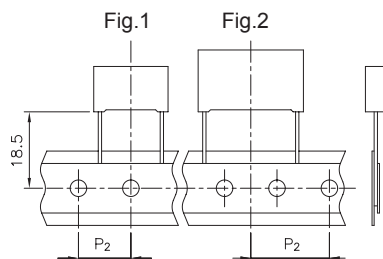
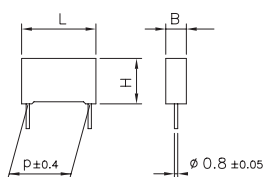

Ød ±0.05	p = 10	15 ≤ p ≤ 27.5	p = 37.5
	0.6	0.8	1.0

All dimensions are in mm.

**PRODUCT CODE SYSTEM**

The part number, comprising 14 digits, is formed as follows:



Digit 1 to 3 Series code.

Digit 4 a.c. rated voltage:  
L = 250V N = 400V 5 = 500V  
7 = 700V 9 = 900V

Digit 5 Pitch: F=10.0mm; l =15.0mm; N=22.5mm;  
R=27.5mm W=37.5mm

Digit 6 to 9 Digits 7 - 8 - 9 indicate the first three digits of Capacitance value and the 6th digit indicates the number of zeros that must be added to obtain the Rated Capacitance in pF.

Digit 10 to 11 Mechanical version and/or packaging (table 1)

Digit 12 Identifies the dimensions and electrical characteristics.

Digit 13 Internal use.

Digit 14 Capacitance tolerance:  
J=5%; K=10%

**METALLIZED POLYPROPYLENE FILM CAPACITOR  
A.C. APPLICATIONS**

**Typical applications:** electronic lighting (i.e. car headlamp and ballast), pulse applications with high A.C. voltage and high current.

**PRODUCT CODE: R74**

Pitch (mm)	Box thickness (B) (mm)	Maximum dimensions (mm)		
		B max	H max	L max
10.0	All	B +0.2	H +0.1	L +0.2
15.0	<7.5	B +0.2	H +0.1	L +0.3
15.0	≥7.5	B +0.2	H +0.1	L +0.5
22.5	All	B +0.2	H +0.1	L +0.3
27.5	All	B +0.2	H +0.1	L +0.3
37.5	All	B +0.3	H +0.1	L +0.3

**GENERAL TECHNICAL DATA**

**Dielectric:** polypropylene film.

**Plates:** aluminium layer deposited by evaporation under vacuum.

**Winding:** non-inductive type.

**Leads:** tinned wire.

**Protection:** plastic case, thermosetting resin filled.  
Box material is solvent resistant and flame retardant according to UL94 V0.

**Marking:** manufacturer's logo, series (R74), dielectric code (MKP), capacitance, tolerance, A.C. rated voltage, manufacturing date code.

**Climatic category:** 55/105/56 IEC 60068-1

**Operating temperature range:** -55 to +105°C

**Related documents:** IEC 60384-16; IEC 60384-17

Table 1 (for more detailed information, please refer to page 14)

Standard packaging style	Lead length (mm)	Taping style			Ordering code (Digit 10 to 11)
		P <sub>2</sub> (mm)	Fig. (No.)	Pitch (mm)	
AMMO-PACK		12.70	1	10.0/15.0	DQ
AMMO-PACK		19.05	2	22.5	DQ
AMMO-PACK	Kinked execution from p=15 mm to p=7.5 mm				KN
AMMO-PACK					KL
REEL Ø 355mm		12.70	1	10.0/15.0	GY
REEL Ø 500mm		12.70	1	10.0/15.0	CK
REEL Ø 500mm		19.05	2	22.5/27.5	CK
Loose, short leads	4 <sup>+2</sup>				AA
Loose, long leads (p=10mm)	17 <sup>+1/2</sup>				JM
Loose, long leads (p≥15mm)	30 <sup>+5</sup>				40
	25 <sup>+2/-1</sup>				50

Note: Ammo-pack is the preferred packaging for taped version.

**Typical application: LAMP CAPACITOR IN ELECTRONIC BALLAST**

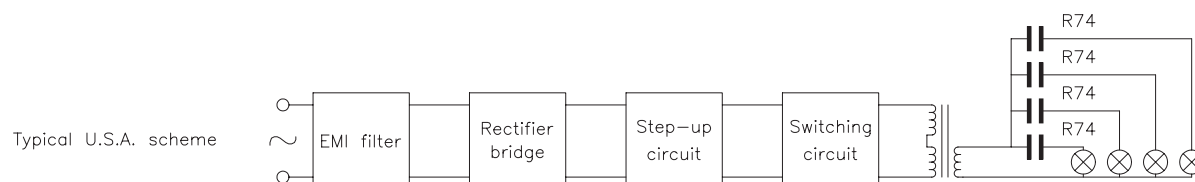

**METALLIZED POLYPROPYLENE FILM CAPACITOR  
A.C. APPLICATIONS**

PRODUCT CODE: R74

single side metallized polypropylene film

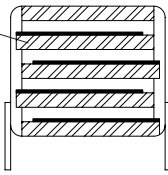

**1 section  
(250 Vac)**

single sided metallized polypropylene film

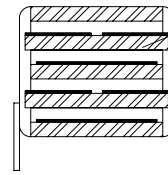

**2 sections  
(400Vac)**

Rated Cap.	250Vac* (1 section) Std dimensions				Max dv/dt (V/μs)	Max K <sub>0</sub> (V <sup>2</sup> /μs)	Part Number
	B	H	L	p			
0.010 μF	4.0	9.0	13.0	10.0	300	38 E4	R74LF2100--0--
0.012 μF	4.0	9.0	13.0	10.0	300	38 E4	R74LF2120--0--
0.015 μF	5.0	11.0	13.0	10.0	300	38 E4	R74LF2150--0--
0.018 μF	5.0	11.0	13.0	10.0	300	38 E4	R74LF2180--0--
0.022 μF	6.0	12.0	13.0	10.0	300	38 E4	R74LF2220--0--
0.027 μF	6.0	12.0	13.0	10.0	300	38 E4	R74LF2270--0--
0.015 μF	5.0	11.0	18.0	15.0	250	31 E4	R74LI 2150--0--
0.018 μF	5.0	11.0	18.0	15.0	250	31 E4	R74LI 2180--0--
0.022 μF	5.0	11.0	18.0	15.0	250	31 E4	R74LI 2220--0--
0.027 μF	5.0	11.0	18.0	15.0	250	31 E4	R74LI 2270--0--
0.033 μF	5.0	11.0	18.0	15.0	250	31 E4	R74LI 2330--0--
0.039 μF	6.0	12.0	18.0	15.0	250	31 E4	R74LI 2390--0--
0.047 μF	6.0	12.0	18.0	15.0	250	31 E4	R74LI 2470--0--
0.056 μF	7.5	13.5	18.0	15.0	250	31 E4	R74LI 2560--0--
0.068 μF	7.5	13.5	18.0	15.0	250	31 E4	R74LI 2680--0--
0.068 μF	9.0	12.5	18.0	15.0	250	31 E4	R74LI 2680--6--
0.082 μF	8.5	14.5	18.0	15.0	250	31 E4	R74LI 2820--0--
0.082 μF	13.0	12.0	18.0	15.0	250	31 E4	R74LI 2820--6--
0.10 μF	8.5	14.5	18.0	15.0	250	31 E4	R74LI 3100--0--
0.10 μF	13.0	12.0	18.0	15.0	250	31 E4	R74LI 3100--6--
0.12 μF	10.0	16.0	18.0	15.0	250	31 E4	R74LI 3120--0--
0.15 μF	11.0	19.0	18.0	15.0	250	31 E4	R74LI 3150--0--

Mechanical version and packaging (Table1) \_\_\_\_\_  
Internal use \_\_\_\_\_  
Tolerance: J (±5%); K (±10%) \_\_\_\_\_

All dimensions are in mm.

Note: If the working voltage (V) is lower than the rated voltage (V<sub>R</sub>), the capacitor may work at higher dv/dt. In this case the maximum value allowed is obtained multiplying the above value (see table dv/dt) with the ratio V<sub>R</sub>/V.  
The pulse characteristic K<sub>0</sub> depends on the voltage wave-form and in any case it cannot overcome the value given in the above table. The dv/dt test is carried out at 2 times the above values.

\*Not suitable for cross-the-line applications. Please refer to Interference Suppression Capacitors (page 145).

Rated Cap.	400Vac (2 sections) Std dimensions				Max dv/dt (V/μs)	Max K <sub>0</sub> (V <sup>2</sup> /μs)	Part Number
	B	H	L	p			
2200 pF	4.0	9.0	13.0	10.0	2200	570 E4	R74NF 1220--0--
2700 pF	4.0	9.0	13.0	10.0	2200	570 E4	R74NF 1270--0--
3300 pF	4.0	9.0	13.0	10.0	2200	570 E4	R74NF 1330--0--
3900 pF	5.0	11.0	13.0	10.0	2200	570 E4	R74NF 1390--0--
4700 pF	5.0	11.0	13.0	10.0	2200	570 E4	R74NF 1470--0--
5600 pF	5.0	11.0	13.0	10.0	2200	570 E4	R74NF 1560--0--
6800 pF	6.0	12.0	13.0	10.0	2200	570 E4	R74NF 1680--0--
8200 pF	6.0	12.0	13.0	10.0	2200	570 E4	R74NF 1820--0--
6800 pF	5.0	11.0	18.0	15.0	2000	520 E4	R74NI 1680--0--
8200 pF	5.0	11.0	18.0	15.0	2000	520 E4	R74NI 1820--0--
0.010 μF	5.0	11.0	18.0	15.0	2000	520 E4	R74NI 2100--0--
0.012 μF	6.0	12.0	18.0	15.0	2000	520 E4	R74NI 2120--0--
0.015 μF	6.0	12.0	18.0	15.0	2000	520 E4	R74NI 2150--0--
0.018 μF	7.5	13.5	18.0	15.0	2000	520 E4	R74NI 2180--0--
0.022 μF	7.5	13.5	18.0	15.0	2000	520 E4	R74NI 2220--0--
0.022 μF	9.0	12.5	18.0	15.0	2000	520 E4	R74NI 2220--6--
0.027 μF	8.5	14.5	18.0	15.0	2000	520 E4	R74NI 2270--0--
0.027 μF	13.0	12.0	18.0	15.0	2000	520 E4	R74NI 2270--6--
0.033 μF	8.5	14.5	18.0	15.0	2000	520 E4	R74NI 2330--0--
0.033 μF	13.0	12.0	18.0	15.0	2000	520 E4	R74NI 2330--6--
0.039 μF	10.0	16.0	18.0	15.0	2000	520 E4	R74NI 2390--0--
0.039 μF	13.0	12.0	18.0	15.0	2000	520 E4	R74NI 2390--6--
0.047 μF	10.0	16.0	18.0	15.0	2000	520 E4	R74NI 2470--0--
0.056 μF	11.0	19.0	18.0	15.0	2000	520 E4	R74NI 2560--0--
0.039 μF	6.0	15.0	26.5	22.5	800	208 E4	R74NN2390--0--
0.047 μF	7.0	16.0	26.5	22.5	800	208 E4	R74NN2470--0--
0.056 μF	7.0	16.0	26.5	22.5	800	208 E4	R74NN2560--0--
0.068 μF	8.5	17.0	26.5	22.5	800	208 E4	R74NN2680--0--
0.082 μF	10.0	18.5	26.5	22.5	800	208 E4	R74NN2820--0--
0.10 μF	10.0	18.5	26.5	22.5	800	208 E4	R74NN3100--0--
0.12 μF	11.0	20.0	26.5	22.5	800	208 E4	R74NN3120--0--
0.15 μF	13.0	22.0	26.5	22.5	800	208 E4	R74NN3150--0--
0.15 μF	9.0	17.0	32.0	27.5	380	70 E4	R74NR3150--0--
0.18 μF	9.0	17.0	32.0	27.5	380	70 E4	R74NR3180--0--
0.22 μF	11.0	20.0	32.0	27.5	380	70 E4	R74NR3220--0--
0.27 μF	11.0	20.0	32.0	27.5	380	70 E4	R74NR3270--0--
0.33 μF	13.0	22.0	32.0	27.5	380	70 E4	R74NR3330--0--
0.39 μF	13.0	22.0	32.0	27.5	380	70 E4	R74NR3390--0--
0.47 μF	14.0	28.0	32.0	27.5	380	70 E4	R74NR3470--0--
0.56 μF	14.0	28.0	32.0	27.5	380	70 E4	R74NR3560--0--
0.68 μF	14.0	28.0	32.0	27.5	380	70 E4	R74NR3680--0--
0.82 μF	18.0	33.0	32.0	27.5	380	70 E4	R74NR3820--0--
1.0 μF	18.0	33.0	32.0	27.5	380	70 E4	R74NR4100--0--
0.47 μF	11.0	22.0	41.5	37.5	180	40 E4	R74NW3470--0--
0.56 μF	11.0	22.0	41.5	37.5	180	40 E4	R74NW3560--0--
0.68 μF	13.0	24.0	41.5	37.5	180	40 E4	R74NW3680--0--
0.82 μF	16.0	28.5	41.5	37.5	180	40 E4	R74NW3820--0--
1.0 μF	16.0	28.5	41.5	37.5	180	40 E4	R74NW4100--0--
1.2 μF	19.0	32.0	41.5	37.5	180	40 E4	R74NW4120--0--
1.5 μF	19.0	32.0	41.5	37.5	180	40 E4	R74NW4150--0--
1.8 μF	20.0	40.0	41.5	37.5	180	40 E4	R74NW4180--0--
2.2 μF	24.0	44.0	41.5	37.5	180	40 E4	R74NW4220--0--
2.7 μF	24.0	44.0	41.5	37.5	180	40 E4	R74NW4270--0--
3.3 μF	30.0	45.0	41.5	37.5	180	40 E4	R74NW4330--0--

Mechanical version and packaging (Table1) \_\_\_\_\_  
Internal use \_\_\_\_\_  
Tolerance: J (±5%); K (±10%) \_\_\_\_\_

**METALLIZED POLYPROPYLENE FILM CAPACITOR  
A.C. APPLICATIONS**

PRODUCT CODE: R74

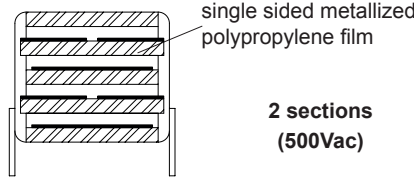

Rated Cap.	500Vac (2 sections) Std dimensions				Max dv/dt (V/μs)	Max K <sub>0</sub> (V <sup>2</sup> μs)	Part Number
	B	H	L	p			
1000 pF	4.0	9.0	13.0	10.0	6000	1920 E4	R745F 1100--0--
1200 pF	4.0	9.0	13.0	10.0	6000	1920 E4	R745F 1120--0--
1500 pF	4.0	9.0	13.0	10.0	6000	1920 E4	R745F 1150--0--
1800 pF	4.0	9.0	13.0	10.0	6000	1920 E4	R745F 1180--0--
2200 pF	5.0	11.0	13.0	10.0	6000	1920 E4	R745F 1220--0--
2700 pF	5.0	11.0	13.0	10.0	6000	1920 E4	R745F 1270--0--
3300 pF	6.0	12.0	13.0	10.0	6000	1920 E4	R745F 1330--0--
3900 pF	6.0	12.0	13.0	10.0	6000	1920 E4	R745F 1390--0--
1500 pF	4.0	10.0	18.0	15.0	4500	1440 E4	R745I 1150--3--
1500 pF	5.0	11.0	18.0	15.0	4500	1440 E4	R745I 1150--0--
1800 pF	4.0	10.0	18.0	15.0	4500	1440 E4	R745I 1180--3--
1800 pF	5.0	11.0	18.0	15.0	4500	1440 E4	R745I 1180--0--
2200 pF	4.0	10.0	18.0	15.0	4500	1440 E4	R745I 1220--3--
2200 pF	5.0	11.0	18.0	15.0	4500	1440 E4	R745I 1220--0--
2700 pF	4.0	10.0	18.0	15.0	4500	1440 E4	R745I 1270--3--
2700 pF	5.0	11.0	18.0	15.0	4500	1440 E4	R745I 1270--0--
3300 pF	4.0	10.0	18.0	15.0	4500	1440 E4	R745I 1330--3--
3300 pF	5.0	11.0	18.0	15.0	4500	1440 E4	R745I 1330--0--
3900 pF	4.0	10.0	18.0	15.0	4500	1440 E4	R745I 1390--3--
3900 pF	5.0	11.0	18.0	15.0	4500	1440 E4	R745I 1390--0--
4700 pF	4.0	10.0	18.0	15.0	4500	1440 E4	R745I 1470--3--
4700 pF	5.0	11.0	18.0	15.0	4500	1440 E4	R745I 1470--0--
5600 pF	5.0	11.0	18.0	15.0	4500	1440 E4	R745I 1560--0--
6800 pF	6.0	12.0	18.0	15.0	4500	1440 E4	R745I 1680--0--
8200 pF	6.0	12.0	18.0	15.0	4500	1440 E4	R745I 1820--0--
0.010 μF	6.0	12.0	18.0	15.0	4500	1440 E4	R745I 2100--0--
0.012 μF	7.5	13.5	18.0	15.0	4500	1440 E4	R745I 2120--0--
0.015 μF	7.5	13.5	18.0	15.0	4500	1440 E4	R745I 2150--0--
0.015 μF	13.0	12.0	18.0	15.0	4500	1440 E4	R745I 2150--6--
0.018 μF	8.5	14.5	18.0	15.0	4500	1440 E4	R745I 2180--0--
0.018 μF	13.0	12.0	18.0	15.0	4500	1440 E4	R745I 2180--6--
0.022 μF	10.0	16.0	18.0	15.0	4500	1440 E4	R745I 2220--0--
0.022 μF	13.0	12.0	18.0	15.0	4500	1440 E4	R745I 2220--6--
0.027 μF	10.0	16.0	18.0	15.0	4500	1440 E4	R745I 2270--0--
0.033 μF	11.0	19.0	18.0	15.0	4500	1440 E4	R745I 2330--0--

Mechanical version and packaging (Table1) \_\_\_\_\_  
Internal use \_\_\_\_\_  
Tolerance: J (±5%); K (±10%) \_\_\_\_\_

Rated Cap.	500Vac (2 sections) Std dimensions				Max dv/dt (V/μs)	Max K <sub>0</sub> (V <sup>2</sup> μs)	Part Number
	B	H	L	p			
0.018 μF	6.0	15.0	26.5	22.5	1800	576 E4	R745N2180--0--
0.022 μF	6.0	15.0	26.5	22.5	1800	576 E4	R745N2220--0--
0.027 μF	7.0	16.0	26.5	22.5	1800	576 E4	R745N2270--0--
0.033 μF	7.0	16.0	26.5	22.5	1800	576 E4	R745N2330--0--
0.039 μF	8.5	17.0	26.5	22.5	1800	576 E4	R745N2390--0--
0.047 μF	10.0	18.5	26.5	22.5	1800	576 E4	R745N2470--0--
0.056 μF	10.0	18.5	26.5	22.5	1800	576 E4	R745N2560--0--
0.068 μF	11.0	20.0	26.5	22.5	1800	576 E4	R745N2680--0--
0.082 μF	13.0	22.0	26.5	22.5	1800	576 E4	R745N2820--0--
0.10 μF	13.0	22.0	26.5	22.5	1800	576 E4	R745N3100--0--
0.10 μF	9.0	17.0	32.0	27.5	500	160 E4	R745R3100--0--
0.12 μF	9.0	17.0	32.0	27.5	500	160 E4	R745R3120--0--
0.15 μF	9.0	17.0	32.0	27.5	500	160 E4	R745R3150--0--
0.18 μF	11.0	20.0	32.0	27.5	500	160 E4	R745R3180--0--
0.22 μF	11.0	20.0	32.0	27.5	500	160 E4	R745R3220--0--
0.27 μF	13.0	22.0	32.0	27.5	500	160 E4	R745R3270--0--
0.33 μF	14.0	28.0	32.0	27.5	500	160 E4	R745R3330--0--
0.39 μF	14.0	28.0	32.0	27.5	500	160 E4	R745R3390--0--
0.47 μF	14.0	28.0	32.0	27.5	500	160 E4	R745R3470--0--
0.56 μF	18.0	33.0	32.0	27.5	500	160 E4	R745R3560--0--
0.68 μF	18.0	33.0	32.0	27.5	500	160 E4	R745R3680--0--
0.82 μF	22.0	37.0	32.0	27.5	500	160 E4	R745R3820--0--
1.0 μF	22.0	37.0	32.0	27.5	500	160 E4	R745R4100--0--
0.33 μF	11.0	22.0	41.5	37.5	300	96 E4	R745W3330--0--
0.39 μF	11.0	22.0	41.5	37.5	300	96 E4	R745W3390--0--
0.47 μF	13.0	24.0	41.5	37.5	300	96 E4	R745W3470--0--
0.56 μF	13.0	24.0	41.5	37.5	300	96 E4	R745W3560--0--
0.68 μF	16.0	28.5	41.5	37.5	300	96 E4	R745W3680--0--
0.82 μF	16.0	28.5	41.5	37.5	300	96 E4	R745W3820--0--
1.0 μF	19.0	32.0	41.5	37.5	300	96 E4	R745W4100--0--
1.2 μF	19.0	32.0	41.5	37.5	300	96 E4	R745W4120--0--
1.5 μF	20.0	40.0	41.5	37.5	300	96 E4	R745W4150--0--
1.8 μF	24.0	44.0	41.5	37.5	300	96 E4	R745W4180--0--
2.2 μF	24.0	44.0	41.5	37.5	300	96 E4	R745W4220--0--

Mechanical version and packaging (Table1) \_\_\_\_\_  
Internal use \_\_\_\_\_  
Tolerance: J (±5%); K (±10%) \_\_\_\_\_

All dimensions are in mm.

Note: If the working voltage (V) is lower than the rated voltage (V<sub>R</sub>), the capacitor may work at higher dv/dt. In this case the maximum value allowed is obtained multiplying the above value (see table dv/dt) with the ratio V<sub>R</sub>/V. The pulse characteristic K<sub>0</sub> depends on the voltage wave-form and in any case it cannot overcome the value given in the above table. The dv/dt test is carried out at 2 times the above values.

**METALLIZED POLYPROPYLENE FILM CAPACITOR  
A.C. APPLICATIONS**

PRODUCT CODE: R74

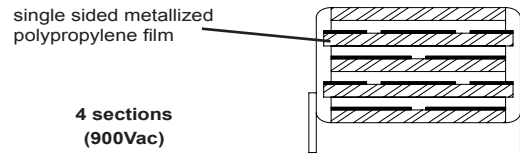
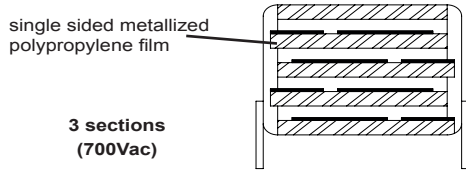

Rated Cap.	700Vac (3 sections) Std dimensions				Max dv/dt (V/μs)	Max K <sub>0</sub> (V <sup>2</sup> /μs)	Part Number
	B	H	L	p			
470 pF	4.0	10.0	18.0	15.0	9500	3800 E4	R7471 0470--3--
680 pF	4.0	10.0	18.0	15.0	9500	3800 E4	R7471 0680--3--
820 pF	4.0	10.0	18.0	15.0	9500	3800 E4	R7471 0820--3--
1000 pF	4.0	10.0	18.0	15.0	9500	3800 E4	R7471 1100--3--
1000 pF	5.0	11.0	18.0	15.0	9500	3800 E4	R7471 1100--0--
1200 pF	4.0	10.0	18.0	15.0	9500	3800 E4	R7471 1120--3--
1200 pF	5.0	11.0	18.0	15.0	9500	3800 E4	R7471 1120--0--
1500 pF	4.0	10.0	18.0	15.0	9500	3800 E4	R7471 1150--3--
1500 pF	5.0	11.0	18.0	15.0	9500	3800 E4	R7471 1150--0--
1800 pF	4.0	10.0	18.0	15.0	9500	3800 E4	R7471 1180--3--
1800 pF	5.0	11.0	18.0	15.0	9500	3800 E4	R7471 1180--0--
2200 pF	4.0	10.0	18.0	15.0	9500	3800 E4	R7471 1220--3--
2200 pF	5.0	11.0	18.0	15.0	9500	3800 E4	R7471 1220--0--
2700 pF	5.0	11.0	18.0	15.0	9500	3800 E4	R7471 1270--0--
3300 pF	5.0	11.0	18.0	15.0	9500	3800 E4	R7471 1330--0--
3900 pF	6.0	12.0	18.0	15.0	9500	3800 E4	R7471 1390--0--
4700 pF	6.0	12.0	18.0	15.0	9500	3800 E4	R7471 1470--0--
5600 pF	6.0	12.0	18.0	15.0	9500	3800 E4	R7471 1560--0--
6800 pF	7.5	13.5	18.0	15.0	9500	3800 E4	R7471 1680--0--
8200 pF	7.5	13.5	18.0	15.0	9500	3800 E4	R7471 1820--0--
8200 pF	9.0	12.5	18.0	15.0	9500	3800 E4	R7471 1820--6--
0.010 μF	8.5	14.5	18.0	15.0	9500	3800 E4	R7471 2100--0--
0.010 μF	13.0	12.0	18.0	15.0	9500	3800 E4	R7471 2100--6--
0.012 μF	10.0	16.0	18.0	15.0	9500	3800 E4	R7471 2120--0--
0.012 μF	13.0	12.0	18.0	15.0	9500	3800 E4	R7471 2120--6--
0.015 μF	10.0	16.0	18.0	15.0	9500	3800 E4	R7471 2150--0--
0.018 μF	11.0	19.0	18.0	15.0	9500	3800 E4	R7471 2180--0--
8200 pF	6.0	15.0	26.5	22.5	4500	1800 E4	R747N1820--0--
0.010 μF	6.0	15.0	26.5	22.5	4500	1800 E4	R747N2100--0--
0.012 μF	6.0	15.0	26.5	22.5	4500	1800 E4	R747N2120--0--
0.015 μF	6.0	15.0	26.5	22.5	4500	1800 E4	R747N2150--0--
0.018 μF	7.0	16.0	26.5	22.5	4500	1800 E4	R747N2180--0--
0.022 μF	8.5	17.0	26.5	22.5	4500	1800 E4	R747N2220--0--
0.027 μF	8.5	17.0	26.5	22.5	4500	1800 E4	R747N2270--0--
0.033 μF	10.0	18.5	26.5	22.5	4500	1800 E4	R747N2330--0--
0.039 μF	10.0	18.5	26.5	22.5	4500	1800 E4	R747N2390--0--
0.047 μF	11.0	20.0	26.5	22.5	4500	1800 E4	R747N2470--0--
0.056 μF	13.0	22.0	26.5	22.5	4500	1800 E4	R747N2560--0--
0.068 μF	13.0	22.0	26.5	22.5	4500	1800 E4	R747N2680--0--
0.039 μF	9.0	17.0	32.0	27.5	700	280 E4	R747R2390--0--
0.047 μF	9.0	17.0	32.0	27.5	700	280 E4	R747R2470--0--
0.056 μF	9.0	17.0	32.0	27.5	700	280 E4	R747R2560--0--
0.068 μF	11.0	20.0	32.0	27.5	700	280 E4	R747R2680--0--
0.082 μF	11.0	20.0	32.0	27.5	700	280 E4	R747R2820--0--
0.10 μF	13.0	22.0	32.0	27.5	700	280 E4	R747R3100--0--
0.12 μF	13.0	22.0	32.0	27.5	700	280 E4	R747R3120--0--
0.15 μF	14.0	28.0	32.0	27.5	700	280 E4	R747R3150--0--
0.18 μF	14.0	28.0	32.0	27.5	700	280 E4	R747R3180--0--
0.22 μF	18.0	33.0	32.0	27.5	700	280 E4	R747R3220--0--
0.27 μF	18.0	33.0	32.0	27.5	700	280 E4	R747R3270--0--
0.33 μF	22.0	37.0	32.0	27.5	700	280 E4	R747R3330--0--
0.15 μF	11.0	22.0	41.5	37.5	400	160 E4	R747W3150--0--
0.18 μF	13.0	24.0	41.5	37.5	400	160 E4	R747W3180--0--
0.22 μF	13.0	24.0	41.5	37.5	400	160 E4	R747W3220--0--
0.27 μF	16.0	28.5	41.5	37.5	400	160 E4	R747W3270--0--
0.33 μF	16.0	28.5	41.5	37.5	400	160 E4	R747W3330--0--
0.39 μF	19.0	32.0	41.5	37.5	400	160 E4	R747W3390--0--
0.47 μF	19.0	32.0	41.5	37.5	400	160 E4	R747W3470--0--
0.56 μF	20.0	40.0	41.5	37.5	400	160 E4	R747W3560--0--
0.68 μF	24.0	44.0	41.5	37.5	400	160 E4	R747W3680--0--
0.82 μF	24.0	44.0	41.5	37.5	400	160 E4	R747W3820--0--
1.0 μF	30.0	45.0	41.5	37.5	400	160 E4	R747W4100--0--

Rated Cap.	900Vac (4 sections) Std dimensions				Max dv/dt (V/μs)	Max K <sub>0</sub> (V <sup>2</sup> /μs)	Part Number
	B	H	L	p			
1000 pF	6.0	15.0	26.5	22.5	2500	1100 E4	R749N1100--0--
1200 pF	6.0	15.0	26.5	22.5	2500	1100 E4	R749N1120--0--
1500 pF	6.0	15.0	26.5	22.5	2500	1100 E4	R749N1150--0--
1800 pF	6.0	15.0	26.5	22.5	2500	1100 E4	R749N1180--0--
2200 pF	6.0	15.0	26.5	22.5	2500	1100 E4	R749N1220--0--
2700 pF	6.0	15.0	26.5	22.5	2500	1100 E4	R749N1270--0--
3300 pF	6.0	15.0	26.5	22.5	2500	1100 E4	R749N1330--0--
3900 pF	6.0	15.0	26.5	22.5	2500	1100 E4	R749N1390--0--
4700 pF	6.0	15.0	26.5	22.5	2500	1100 E4	R749N1470--0--
5600 pF	6.0	15.0	26.5	22.5	2500	1100 E4	R749N1560--0--
6800 pF	6.0	15.0	26.5	22.5	2500	1100 E4	R749N1680--0--
8200 pF	7.0	16.0	26.5	22.5	2500	1100 E4	R749N1820--0--
0.010 μF	7.0	16.0	26.5	22.5	2500	1100 E4	R749N2100--0--
0.012 μF	8.5	17.0	26.5	22.5	2500	1100 E4	R749N2120--0--
0.015 μF	10.0	18.5	26.5	22.5	2500	1100 E4	R749N2150--0--
0.018 μF	10.0	18.5	26.5	22.5	2500	1100 E4	R749N2180--0--
0.022 μF	11.0	20.0	26.5	22.5	2500	1100 E4	R749N2220--0--
0.027 μF	13.0	22.0	26.5	22.5	2500	1100 E4	R749N2270--0--
0.033 μF	13.0	22.0	26.5	22.5	2500	1100 E4	R749N2330--0--
0.022 μF	9.0	17.0	32.0	27.5	1500	660 E4	R749R2220--0--
0.027 μF	9.0	17.0	32.0	27.5	1500	660 E4	R749R2270--0--
0.033 μF	11.0	20.0	32.0	27.5	1500	660 E4	R749R2330--0--
0.039 μF	11.0	20.0	32.0	27.5	1500	660 E4	R749R2390--0--
0.047 μF	13.0	22.0	32.0	27.5	1500	660 E4	R749R2470--0--
0.056 μF	13.0	22.0	32.0	27.5	1500	660 E4	R749R2560--0--
0.068 μF	14.0	28.0	32.0	27.5	1500	660 E4	R749R2680--0--
0.082 μF	14.0	28.0	32.0	27.5	1500	660 E4	R749R2820--0--
0.10 μF	18.0	33.0	32.0	27.5	1500	660 E4	R749R3100--0--
0.12 μF	18.0	33.0	32.0	27.5	1500	660 E4	R749R3120--0--
0.15 μF	18.0	33.0	32.0	27.5	1500	660 E4	R749R3150--0--
0.068 μF	11.0	22.0	41.5	37.5	900	400 E4	R749W2680--0--
0.082 μF	11.0	22.0	41.5	37.5	900	400 E4	R749W2820--0--
0.10 μF	13.0	24.0	41.5	37.5	900	400 E4	R749W3100--0--
0.12 μF	13.0	24.0	41.5	37.5	900	400 E4	R749W3120--0--
0.15 μF	16.0	28.5	41.5	37.5	900	400 E4	R749W3150--0--
0.18 μF	16.0	28.5	41.5	37.5	900	400 E4	R749W3180--0--
0.22 μF	19.0	32.0	41.5	37.5	900	400 E4	R749W3220--0--
0.27 μF	20.0	40.0	41.5	37.5	900	400 E4	R749W3270--0--
0.33 μF	20.0	40.0	41.5	37.5	900	400 E4	R749W3330--0--
0.39 μF	24.0	44.0	41.5	37.5	900	400 E4	R749W3390--0--
0.47 μF	24.0	44.0	41.5	37.5	900	400 E4	R749W3470--0--

Mechanical version and packaging (Table1) \_\_\_\_\_  
Internal use \_\_\_\_\_  
Tolerance: J (±5%); K (±10%) \_\_\_\_\_

All dimensions are in mm.

Note: If the working voltage (V) is lower than the rated voltage (V<sub>R</sub>), the capacitor may work at higher dv/dt. In this case the maximum value allowed is obtained multiplying the above value (see table dv/dt) with the ratio V<sub>R</sub>/V.  
The pulse characteristic K<sub>0</sub> depends on the voltage wave-form and in any case it cannot overcome the value given in the above table.  
The dv/dt test is carried out at 2 times the above values.

Mechanical version and packaging (Table1) \_\_\_\_\_  
Internal use \_\_\_\_\_  
Tolerance: J (±5%); K (±10%) \_\_\_\_\_

**METALLIZED POLYPROPYLENE FILM CAPACITOR  
A.C. APPLICATIONS**

PRODUCT CODE: R74

**ELECTRICAL CHARACTERISTICS**

**Rated voltage ( $V_R$ ):**

250Vac ( 630Vdc) - 400Vac (1300Vdc)  
500Vac (1600Vdc) - 700Vac (2000Vdc)  
900Vac (2200Vdc)

**Rated temperature ( $T_R$ ):** +85°C

**Temperature derated voltage:**

for temperatures between +85°C and +105°C a decreasing factor of 1.25% per degree °C on the rated voltage  $V_R$  (a.c. and d.c.) has to be applied.

**Capacitance range:**

470pF to 3.3  $\mu$ F

**Capacitance values:**

E12 series (IEC 60063 Norm).

**Capacitance tolerances** (measured at 1 kHz):

$\pm 5\%$  (J);  $\pm 10\%$  (K).

**Total self inductance:** (L)

(Lead length (2 mm))

Pitch (mm)	10	15	22.5	27.5	37.5
L (nH) $\approx$	9	10	18	18	20

**Dissipation factor (DF):**

$tg\delta$   $10^{-4}$  at +25°C  $\pm 5^\circ$ C

	1kHz	10kHz	100kHz
$C \leq 2.2nF$	$\leq 1.0$	$\leq 2.0$	$\leq 3.0$
$2.2nF < C \leq 0.027\mu F$	$\leq 1.0$	$\leq 2.0$	$\leq 8.0$
$0.027\mu F < C \leq 0.1\mu F$	$\leq 4.0$	$\leq 6.0$	$\leq 25.0$
$0.1\mu F < C \leq 1\mu F$	$\leq 5.0$	$\leq 8.0$	
$C > 1\mu F$	$\leq 6.0$		

**Insulation resistance:**

**Test conditions**

Temperature: +25°C  $\pm 5^\circ$ C  
Voltage charge time: 1 min  
Voltage charge: 100Vdc

**Performance**

$\geq 1 \times 10^5 M\Omega$  for  $C \leq 0.33\mu F$   
 $\geq 30000s$  for  $C > 0.33\mu F$

**Test voltage between terminations:**

$1.6 \times V_R$  applied for 2 s at 25°C  $\pm 5^\circ$ C

**TEST METHOD AND PERFORMANCE**

**Damp heat, steady state:**

**Test conditions**

Temperature: +40°C  $\pm 2^\circ$ C  
Relative humidity (RH): 93%  $\pm 2\%$   
Test duration: 56 days

**Performance**

Capacitance change  $|\Delta C/C|$ :  $\leq 2\%$   
DF change ( $\Delta tg\delta$ ):  $\leq 10 \times 10^{-4}$  at 1kHz  
Insulation resistance:  $\geq 50\%$  of initial limit.

**Endurance:**

**Test conditions**

Temperature: +85°C  $\pm 2^\circ$ C  
Test duration: 2000 h  
Voltage applied:  $1.25 \times V_R$  (a.c.) at 50Hz

**Performance**

Capacitance change  $|\Delta C/C|$ :  $\leq 5\%$   
DF change ( $\Delta tg\delta$ ):  $\leq 15 \times 10^{-4}$  at 10kHz  
Insulation resistance:  $\geq 50\%$  of initial limit.

**Resistance to soldering heat:**

**Test conditions**

Solder bath temperature: 260°C  $\pm 5^\circ$ C  
Dipping time (with heat screen): 10 s  $\pm 1$  s

**Performance**

Capacitance change  $|\Delta C/C|$ :  $\leq 1\%$   
DF change ( $\Delta tg\delta$ ):  $\leq 10 \times 10^{-4}$  at 10kHz  
Insulation resistance:  $\geq$  initial limit.

**Long term stability** (after two years):

**Storage:** standard environmental conditions (page 12).

**Performance**

Capacitance change  $|\Delta C/C|$ :  $\leq 0.5\%$

MAX. VOLTAGE (Vr.m.s.) VERSUS FREQUENCY (sinusoidal wave-form / Th ≤ 85°C)

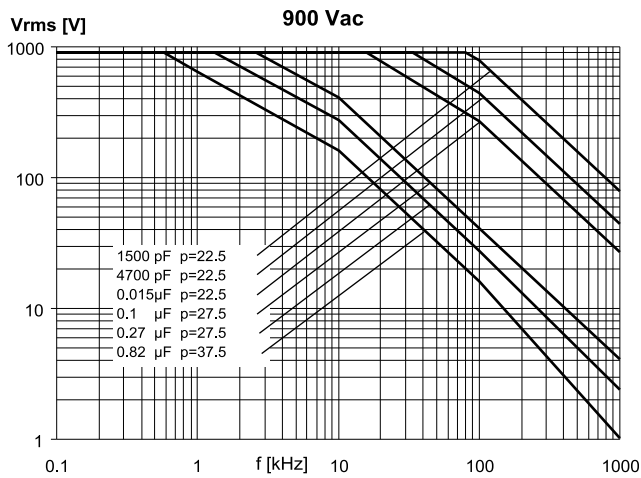
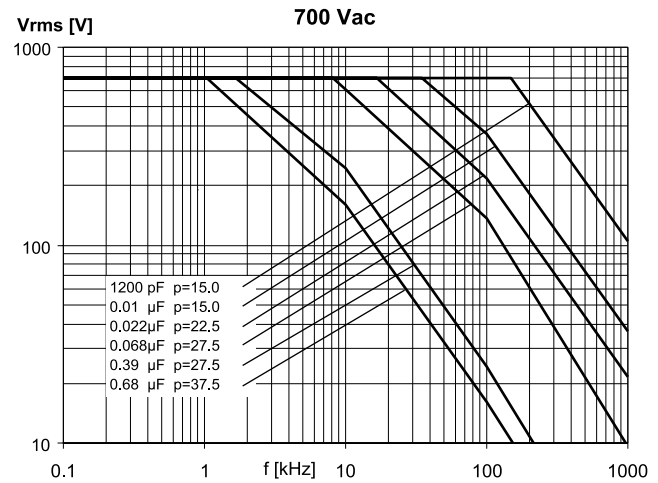
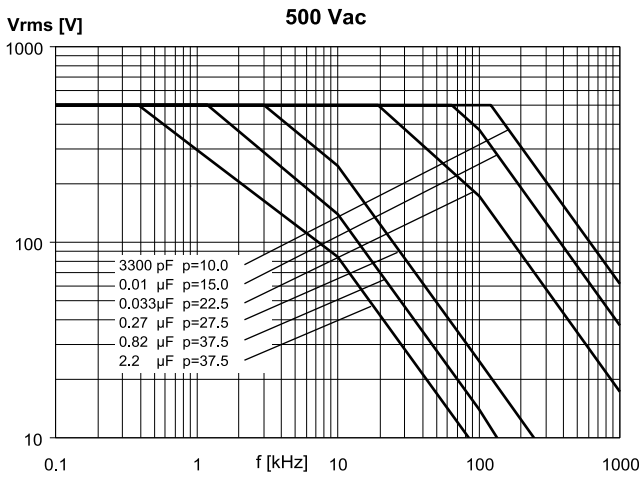
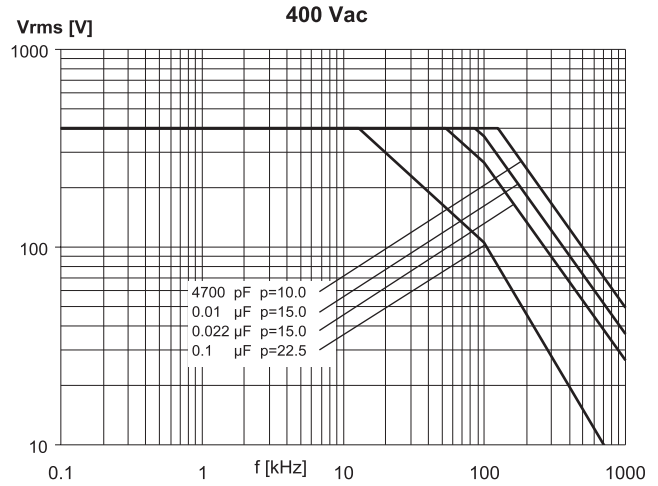
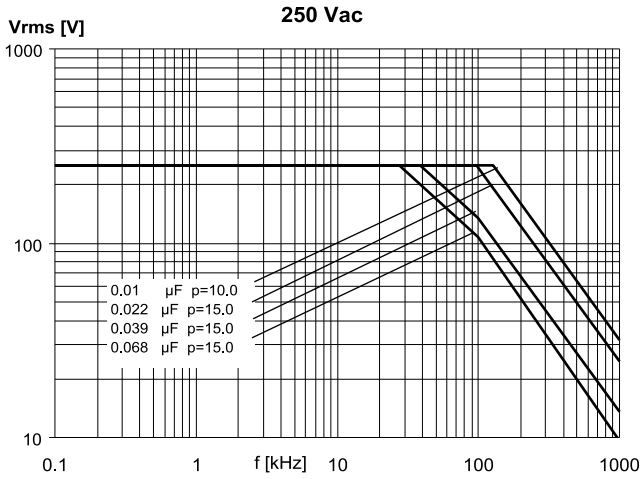

Note: p (pitch) in mm.

MAX. CURRENT (I<sub>r.m.s.</sub>) VERSUS FREQUENCY (sinusoidal wave-form / Th ≤ 85°C)

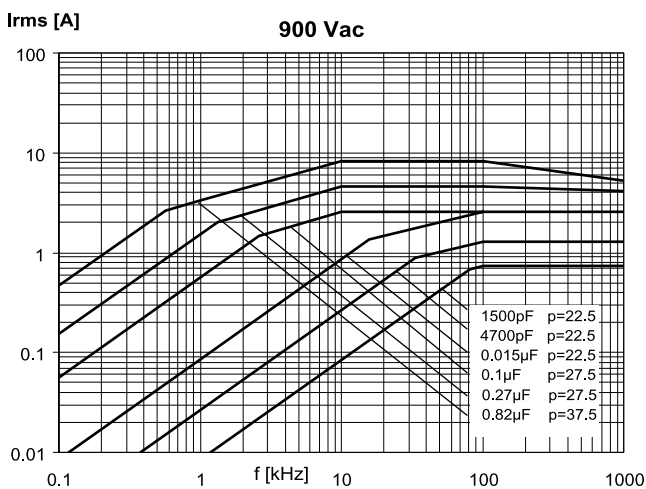
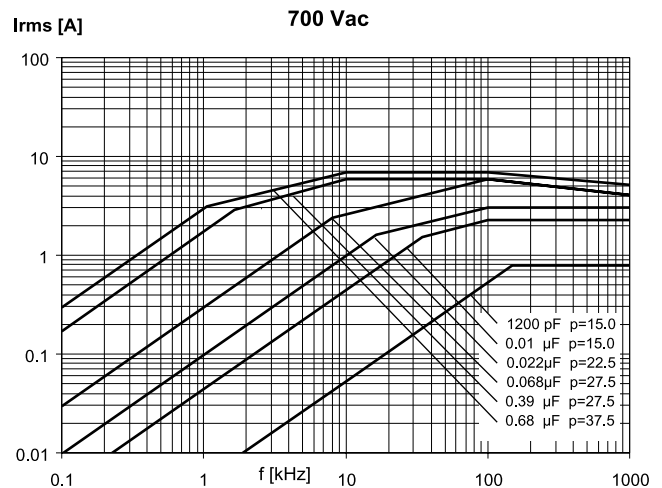
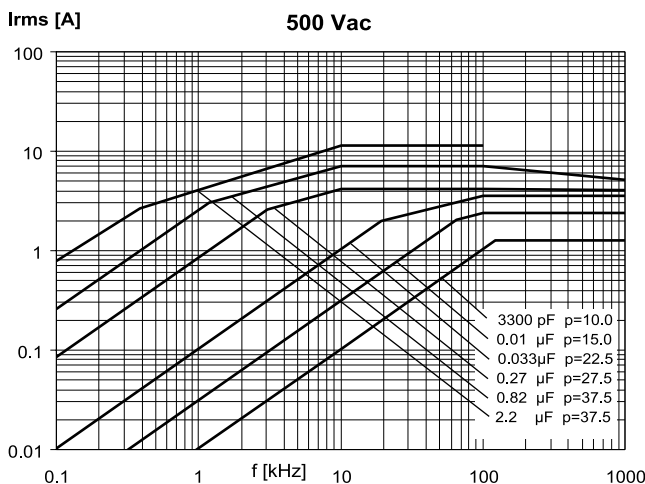
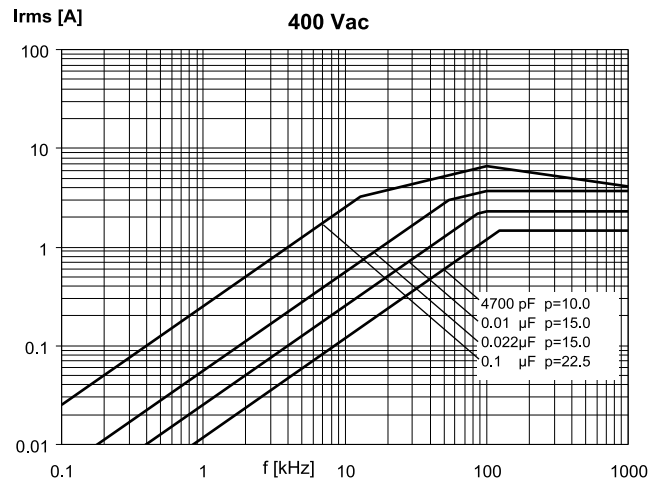
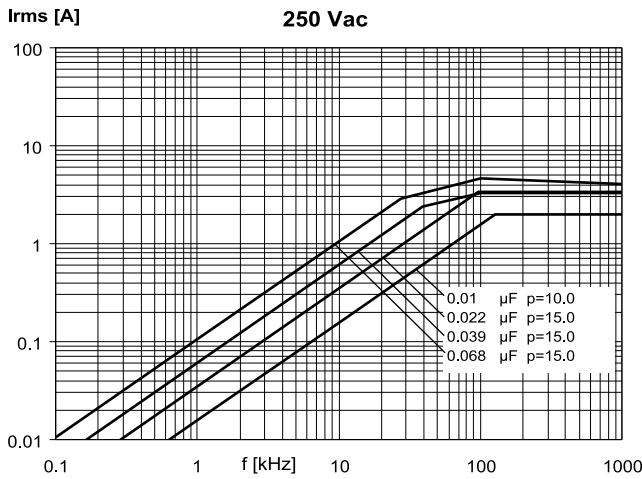

Note: p (pitch) in mm.

Loose

Taped

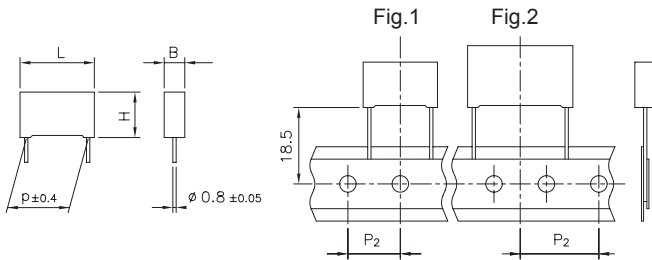

Ød ±0.05	p = 10	p = 15
	0.6	0.8

All dimensions are in mm.

**PRODUCT CODE SYSTEM**

The part number, comprising 14 digits, is formed as follows:

1	2	3	4	5	6	7	8	9	10	11	12	13	14
R	7	4	7								R	-	

- Digit 1 to 3 Series code.
- Digit 4 a.c. rated voltage:  
6 = 600V
- Digit 5 Pitch: F=10.0mm; I =15.0mm.
- Digit 6 to 9 Digits 7 - 8 - 9 indicate the first three digits of Capacitance value and the 6th digit indicates the number of zeros that must be added to obtain the Rated Capacitance in pF.
- Digit 10 to 11 Mechanical version and/or packaging (table 1)
- Digit 12 Identifies the dimensions and electrical characteristics.
- Digit 13 Internal use.
- Digit 14 Capacitance tolerance:  
J=5%; K=10%

**METALLIZED POLYPROPYLENE FILM CAPACITOR  
A.C. APPLICATIONS**

**Typical applications:** electronic lighting (i.e. car headlamp and ballast), pulse applications with high A.C. voltage and high current.

**PRODUCT CODE: R74**

Pitch (mm)	Box thickness (B) (mm)	Maximum dimensions (mm)		
		B max	H max	L max
10.0	All	B +0.2	H +0.1	L +0.2
15.0	<7.5	B +0.2	H +0.1	L +0.3
15.0	≥7.5	B +0.2	H +0.1	L +0.5

**GENERAL TECHNICAL DATA**

- Dielectric:** polypropylene film.
- Plates:** aluminium layer deposited by evaporation under vacuum.
- Winding:** non-inductive type.
- Leads:** tinned wire.
- Protection:** plastic case, thermosetting resin filled.  
Box material is solvent resistant and flame retardant according to UL94 V-0.
- Marking:** manufacturer's logo, series (R74), dielectric code (MKP), capacitance, tolerance, A.C. rated voltage, manufacturing date code.
- Climatic category:** 55/105/56 IEC 60068-1
- Operating temperature range:** -55 to +105°C
- Related documents:** IEC 60384-16; IEC 60384-17

Table 1 (for more detailed information, please refer to page 14)

Standard packaging style	Lead length (mm)	Taping style			Ordering code (Digit 10 to 11)
		P <sub>2</sub> (mm)	Fig. (No.)	Pitch (mm)	
AMMO-PACK		12.70	1	10.0/15.0	DQ
AMMO-PACK	Kinked execution from p=15 mm to p=7.5 mm				KN
AMMO-PACK					KL
REEL Ø 355mm		12.70	1	10.0/15.0	GY
REEL Ø 500mm		12.70	1	10.0/15.0	CK
Loose, short leads	4 <sup>+2</sup>				AA
Loose, long leads (p=10mm)	17 <sup>-2/+1</sup>				JM
Loose, long leads (p≥15mm)	30 <sup>+5</sup> 25 <sup>-1/+2</sup>				40 50

Note: Ammo-pack is the preferred packaging for taped version.

**Typical application: LAMP CAPACITOR IN ELECTRONIC BALLAST**

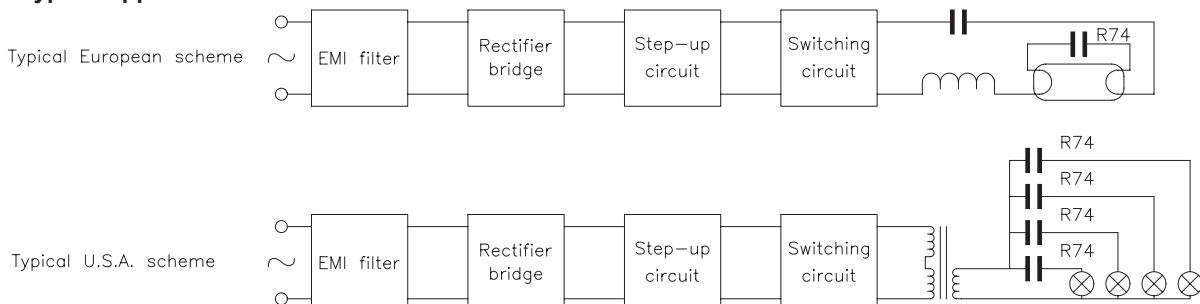



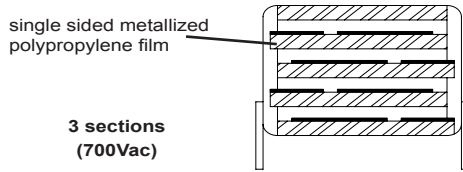

Rated Cap.	600Vac (3 sections) Std dimensions				Max dv/dt (V/μs)	Max K <sub>0</sub> (V <sup>2</sup> /μs)	Part Number
	B	H	L	p			
470 pF	4.0	9.0	13.0	10.0	10000	4000 E4	R746F0470--0--
680 pF	4.0	9.0	13.0	10.0	10000	4000 E4	R746F0680--0--
820 pF	4.0	9.0	13.0	10.0	10000	4000 E4	R746F0820--0--
1000 pF	4.0	9.0	13.0	10.0	10000	4000 E4	R746F1100--0--
1200 pF	4.0	9.0	13.0	10.0	10000	4000 E4	R746F1120--0--
1500 pF	4.0	9.0	13.0	10.0	10000	4000 E4	R746F1150--0--
1800 pF	4.0	9.0	13.0	10.0	10000	4000 E4	R746F1180--0--
2200 pF	5.0	11.0	13.0	10.0	10000	4000 E4	R746F1220--0--
2700 pF	5.0	11.0	13.0	10.0	10000	4000 E4	R746F1270--0--
3300 pF	6.0	12.0	13.0	10.0	10000	4000 E4	R746F1330--0--
3900 pF	6.0	12.0	13.0	10.0	10000	4000 E4	R746F1390--0--
2300 pF	4.0	10.0	18.0	15.0	9500	3800 E4	R746I1230--0--
2700 pF	4.0	10.0	18.0	15.0	9500	3800 E4	R746I1270--0--
3900 pF	5.0	11.0	18.0	15.0	9500	3800 E4	R746I1390--0--
4700 pF	5.0	11.0	18.0	15.0	9500	3800 E4	R746I1470--0--
6800 pF	6.0	12.0	18.0	15.0	9500	3800 E4	R746I1680--0--
0.012 μF	8.5	14.5	18.0	15.0	9500	3800 E4	R746I2120--0--
0.015 μF	8.5	14.5	18.0	15.0	9500	3800 E4	R746I2150--0--
0.018 μF	10.0	16.0	18.0	15.0	9500	3800 E4	R746I2180--0--

Mechanical version and packaging (Table1) \_\_\_\_\_  
 Internal use \_\_\_\_\_  
 Tolerance: J (±5%); K (±10%) \_\_\_\_\_

All dimensions are in mm.

Note: If the working voltage (V) is lower than the rated voltage (V<sub>R</sub>), the capacitor may work at higher dv/dt. In this case the maximum value allowed is obtained multiplying the above value (see table dv/dt) with the ratio V<sub>R</sub>/V.  
 The pulse characteristic K<sub>0</sub> depends on the voltage wave-form and in any case it cannot overcome the value given in the above table.  
 The dv/dt test is carried out at 2 times the above values.

**METALLIZED POLYPROPYLENE FILM CAPACITOR  
A.C. APPLICATIONS**

PRODUCT CODE: R74

**ELECTRICAL CHARACTERISTICS**

**Rated voltage ( $V_R$ ):**

600Vac (2000Vdc)

**Rated temperature ( $T_R$ ):** +85°C

**Temperature derated voltage:**

for temperatures between +85°C and +105°C a decreasing factor of 1.25% per degree °C on the rated voltage  $V_R$  (a.c. and d.c.) has to be applied.

**Capacitance range:**

470pF to 0.018µF

**Capacitance values:**

E12 series (IEC 60063 Norm).

**Capacitance tolerances** (measured at 1 kHz):

±5% (J); ±10% (K).

**Total self inductance:** (L)

(Lead length (2 mm))

Pitch (mm)	10	15
L (nH) ≈	9	10

**Dissipation factor (DF):**

tgδ 10<sup>-4</sup> at +25°C ±5°C

	1kHz	100kHz
All	≤ 15	≤ 15

**Insulation resistance:**

**Test conditions**

Temperature: +25°C±5°C  
Voltage charge time: 1 min  
Voltage charge: 100Vdc

**Performance**

≥1x10<sup>5</sup> MΩ

**Test voltage between terminations:**

1.6x $V_R$  applied for 2 s at 25°C±5°C

**TEST METHOD AND PERFORMANCE**

**Damp heat, steady state:**

**Test conditions**

Temperature: +40°C±2°C  
Relative humidity (RH): 93% ±2%  
Test duration: 56 days

**Performance**

Capacitance change |ΔC/C|: ≤2%  
DF change (Δtgδ): ≤10x10<sup>-4</sup> at 1kHz  
Insulation resistance: ≥50% of initial limit.

**Endurance:**

**Test conditions**

Temperature: +85°C±2°C  
Test duration: 2000 h  
Voltage applied:  $V_R$  (a.c.) at 50Hz

**Performance**

Capacitance change |ΔC/C|: ≤10%  
DF change (Δtgδ): ≤15x10<sup>-4</sup> at 10kHz  
Insulation resistance: ≥50% of initial limit.

**Resistance to soldering heat:**

**Test conditions**

Solder bath temperature: 260°C±5°C  
Dipping time (with heat screen): 10 s±1 s

**Performance**

Capacitance change |ΔC/C|: ≤1%  
DF change (Δtgδ): ≤10x10<sup>-4</sup> at 10kHz  
Insulation resistance: ≥initial limit.

**Long term stability** (after two years):

**Storage:** standard environmental conditions (page 12).

**Performance**

Capacitance change |ΔC/C|: ≤1%

MAX. VOLTAGE ( $V_{r.m.s.}$ ) VERSUS FREQUENCY (sinusoidal wave-form /  $T_h \leq 85^\circ\text{C}$ )

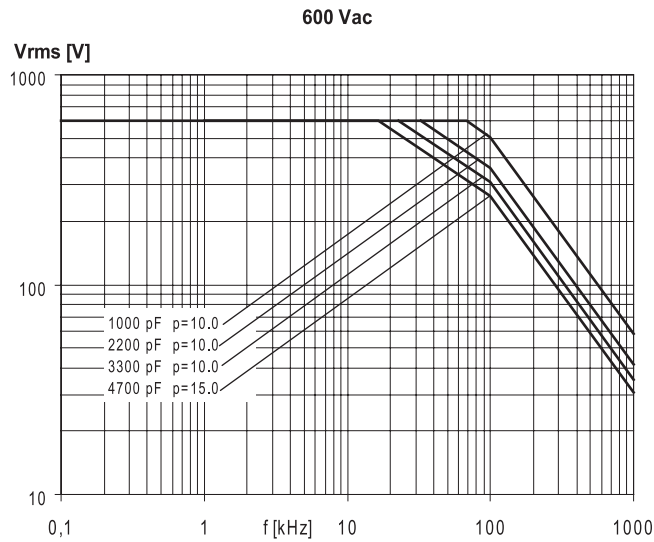

MAX. CURRENT ( $I_{r.m.s.}$ ) VERSUS FREQUENCY (sinusoidal wave-form /  $T_h \leq 85^\circ\text{C}$ )

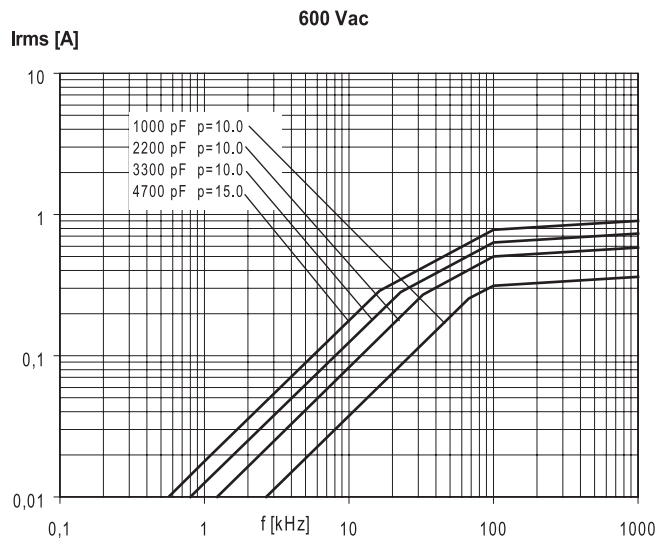

Loose

Taped

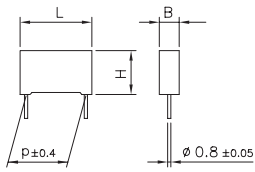
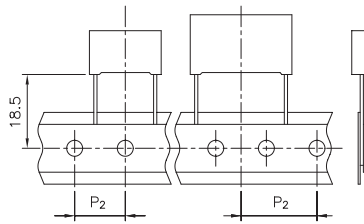

Fig.1

Fig.2



Ød ±0.05	p = 10	p ≥ 15
	0.6	0.8

All dimensions are in mm.

**PRODUCT CODE SYSTEM**

The part number, comprising 14 digits, is formed as follows:



Digit 1 to 3 Series code.

Digit 4 a.c. rated voltage:  
5 = 500V 7 = 700V

Digit 5 Pitch: F=10.0mm; I =15.0mm; N=22.5mm;  
Digit 6 to 9 Digits 7 - 8 - 9 indicate the first three digits of Capacitance value and the 6th digit indicates the number of zeros that must be added to obtain the Rated Capacitance in pF.

Digit 10 to 11 Mechanical version and/or packaging (table 1)

Digit 12 Identifies the dimensions and electrical characteristics.

Digit 13 Internal use.

Digit 14 Capacitance tolerance:  
J=5%; K=10%

Table 1 (for more detailed information, please refer to page 14)

Standard packaging style	Lead length (mm)	Taping style			Ordering code (Digit 10 to 11)
		P <sub>2</sub> (mm)	Fig. (No.)	Pitch (mm)	
AMMO-PACK		12.70	1	10.0/15.0	DQ
AMMO-PACK		19.05	2	22.5	DQ
AMMO-PACK	Kinked execution from p=15 mm to p=7.5 mm				KN
AMMO-PACK					KL
REEL Ø 355mm		12.70	1	10.0/15.0	GY
REEL Ø 500mm		12.70	1	10.0/15.0	CK
REEL Ø 500mm		19.05	2	22.5	CK
Loose, short leads	4 <sup>+2</sup>				AA
Loose, long leads (p=10mm)	17 <sup>+1/-2</sup>				JM
Loose, long leads (p≥15mm)	30 <sup>+5</sup> 25 <sup>+2/-1</sup>				40 50

Note: Ammo-pack is the preferred packaging for taped version.

**Typical application: LAMP CAPACITOR IN ELECTRONIC BALLAST**

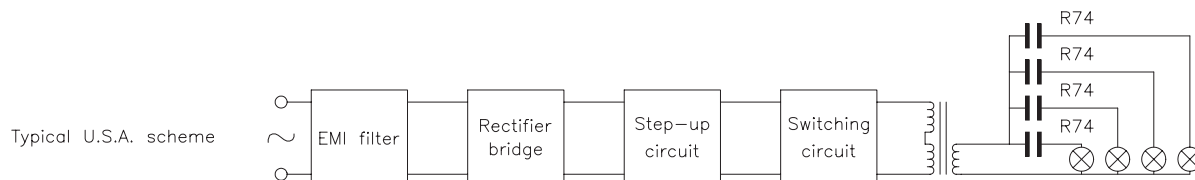

**METALLIZED POLYPROPYLENE FILM CAPACITOR  
A.C. APPLICATIONS**

**Typical applications:** electronic lighting (i.e. car headlamp and ballast), pulse applications with high A.C. voltage and high current.

**PRODUCT CODE: R74**

Pitch (mm)	Box thickness (mm)	Maximum dimensions (mm)		
		B max	H max	L max
10.0	All	B +0.2	H +0.1	L +0.2
15.0	<7.5	B +0.2	H +0.1	L +0.3
15.0	≥7.5	B +0.2	H +0.1	L +0.5
22.5	All	B +0.2	H +0.1	L +0.3

**GENERAL TECHNICAL DATA**

**Dielectric:** polypropylene film.

**Plates:** aluminium layer deposited by evaporation under vacuum.

**Winding:** non-inductive type.

**Leads:** tinned wire.

**Protection:** plastic case, thermosetting resin filled. Box material is solvent resistant and flame retardant according to UL94 V0.

**Marking:** manufacturer's logo, series (R74), dielectric code (MKP), capacitance, tolerance, A.C. rated voltage, manufacturing date code.

**Climatic category:** 55/125/56 IEC 60068-1

**Operating temperature range:** -55 to +125°C

**Related documents:** IEC 60384-16; IEC 60384-17

**METALLIZED POLYPROPYLENE FILM CAPACITOR  
A.C. APPLICATIONS**

PRODUCT CODE: R74

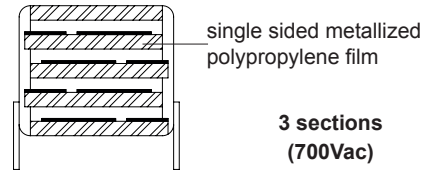
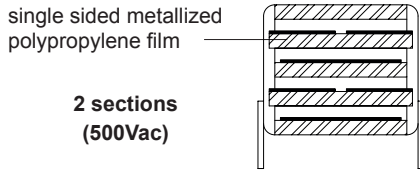

Rated Cap.	500Vac (2 sections) Std dimensions				Max dv/dt (V/μs)	Max K <sub>0</sub> (V <sup>2</sup> /μs)	Part Number
	B	H	L	p			
1000 pF	4.0	9.0	13.0	10.0	6000	1.28 E7	R745F 1100--H0-
1200 pF	4.0	9.0	13.0	10.0	6000	1.28 E7	R745F 1120--H0-
1500 pF	4.0	9.0	13.0	10.0	6000	1.28 E7	R745F 1150--H0-
1800 pF	5.0	11.0	13.0	10.0	6000	1.28 E7	R745F 1180--H0-
2200 pF	5.0	11.0	13.0	10.0	6000	1.28 E7	R745F 1220--H0-
2700 pF	5.0	11.0	13.0	10.0	6000	1.28 E7	R745F 1270--H0-
3300 pF	6.0	12.0	13.0	10.0	6000	1.28 E7	R745F 1330--H0-
3900 pF	6.0	12.0	13.0	10.0	6000	1.28 E7	R745F 1390--H0-
2700 pF	4.0	10.0	18.0	15.0	4500	8.00 E6	R745I 1270--H3-
3300 pF	4.0	10.0	18.0	15.0	4500	8.00 E6	R745I 1330--H3-
3900 pF	4.0	10.0	18.0	15.0	4500	8.00 E6	R745I 1390--H3-
4700 pF	5.0	11.0	18.0	15.0	4500	8.00 E6	R745I 1470--H0-
5600 pF	5.0	11.0	18.0	15.0	4500	8.00 E6	R745I 1560--H0-
6800 pF	6.0	12.0	18.0	15.0	4500	8.00 E6	R745I 1680--H0-
8200 pF	6.0	12.0	18.0	15.0	4500	8.00 E6	R745I 1820--H0-
0.010 μF	6.0	12.0	18.0	15.0	4500	8.00 E6	R745I 2100--H0-
0.012 μF	7.5	13.5	18.0	15.0	4500	8.00 E6	R745I 2120--H0-
0.015 μF	7.5	13.5	18.0	15.0	4500	8.00 E6	R745I 2150--H0-
0.015 μF	13.0	12.0	18.0	15.0	4500	8.00 E6	R745I 2150--H1-
0.018 μF	8.5	14.5	18.0	15.0	4500	8.00 E6	R745I 2180--H0-
0.018 μF	13.0	12.0	18.0	15.0	4500	8.00 E6	R745I 2180--H1-
0.022 μF	10.0	16.0	18.0	15.0	4500	8.00 E6	R745I 2220--H0-
0.022 μF	13.0	12.0	18.0	15.0	4500	8.00 E6	R745I 2220--H1-
0.027 μF	10.0	16.0	18.0	15.0	4500	8.00 E6	R745I 2270--H0-
0.033 μF	11.0	19.0	18.0	15.0	4500	8.00 E6	R745I 2330--H0-
0.018 μF	6.0	15.0	26.5	22.5	1200	3.84 E6	R745N2180--H0-
0.022 μF	6.0	15.0	26.5	22.5	1200	3.84 E4	R745N2220--H0-
0.027 μF	7.0	16.0	26.5	22.5	1200	3.84 E4	R745N2270--H0-
0.033 μF	7.0	16.0	26.5	22.5	1200	3.84 E4	R745N2330--H0-
0.039 μF	8.5	17.0	26.5	22.5	1200	3.84 E4	R745N2390--H0-
0.047 μF	10.0	18.5	26.5	22.5	1200	3.84 E4	R745N2470--H0-
0.056 μF	10.0	18.5	26.5	22.5	1200	3.84 E4	R745N2560--H0-
0.068 μF	11.0	20.0	26.5	22.5	1200	3.84 E4	R745N2680--H0-
0.082 μF	13.0	22.0	26.5	22.5	1200	3.84 E4	R745N2820--H0-
0.10 μF	13.0	22.0	26.5	22.5	1200	3.84 E4	R745N3100--H0-

Mechanical version and packaging (Table1) \_\_\_\_\_  
Internal use \_\_\_\_\_  
Tolerance: J (±5%); K (±10%) \_\_\_\_\_

All dimensions are in mm

Note: If the working voltage (V) is lower than the rated voltage (V<sub>R</sub>), the capacitor may work at higher dv/dt. In this case the maximum value allowed is obtained multiplying the above value (see table dv/dt) with the ratio V<sub>R</sub>/V. The pulse characteristic K<sub>0</sub> depends on the voltage waveform and in any case it cannot overcome the value given in the above table. The dv/dt test is carried out at 2 times the above values.

Rated Cap.	700Vac (3 sections) Std dimensions				Max dv/dt (V/μs)	Max K <sub>0</sub> (V <sup>2</sup> /μs)	Part Number
	B	H	L	p			
680 pF	4.0	10.0	18.0	15.0	9500	960 E4	R747I0680--H3-
820 pF	4.0	10.0	18.0	15.0	9500	960 E4	R747I0820--H3-
1000 pF	4.0	10.0	18.0	15.0	9500	960 E4	R747I1100--H3-
1200 pF	4.0	10.0	18.0	15.0	9500	960 E4	R747I1120--H3-
1300 pF	4.0	10.0	18.0	15.0	9500	960 E4	R747I1130--H3-
1800 pF	4.0	10.0	18.0	15.0	9500	960 E4	R747I1180--H3-
2200 pF	4.0	10.0	18.0	15.0	9500	960 E4	R747I1220--H3-
2500 pF	4.0	10.0	18.0	15.0	9500	960 E4	R747I1250--H3-
2700 pF	5.0	11.0	18.0	15.0	9500	960 E4	R747I1270--H0-
3300 pF	5.0	11.0	18.0	15.0	9500	960 E4	R747I1330--H0-
3600 pF	6.0	12.0	18.0	15.0	9500	960 E4	R747I1360--H0-
3900 pF	6.0	12.0	18.0	15.0	9500	960 E4	R747I1390--H0-
4300 pF	6.0	12.0	18.0	15.0	9500	960 E4	R747I1430--H0-
4700 pF	6.0	12.0	18.0	15.0	9500	960 E4	R747I1470--H0-
5200 pF	6.0	12.0	18.0	15.0	9500	960 E4	R747I1520--H0-
5600 pF	6.0	12.0	18.0	15.0	9500	960 E4	R747I1560--H0-
6200 pF	7.5	13.5	18.0	15.0	9500	960 E4	R747I1620--H0-
6800 pF	7.5	13.5	18.0	15.0	9500	960 E4	R747I1680--H0-
8200 pF	7.5	13.5	18.0	15.0	9500	960 E4	R747I1820--H0-
8200 pF	9.0	12.5	18.0	15.0	9500	960 E4	R747I1360--H1-
0.010 μF	8.5	14.5	18.0	15.0	9500	960 E4	R747I2100--H0-
0.010 μF	13.0	12.0	18.0	15.0	9500	960 E4	R747I2100--H1-
0.012 μF	10.0	16.0	18.0	15.0	9500	960 E4	R747I2120--H0-
0.012 μF	13.0	12.0	18.0	15.0	9500	960 E4	R747I2120--H1-
0.015 μF	10.0	16.0	18.0	15.0	9500	960 E4	R747I2150--H0-
0.018 μF	11.0	19.0	18.0	15.0	9500	960 E4	R747I2180--H0-
6200 pF	6.0	15.0	26.5	22.5	4500	420 E4	R747N1620--H0-
6800 pF	6.0	15.0	26.5	22.5	4500	420 E4	R747N1680--H0-
7500 pF	6.0	15.0	26.5	22.5	4500	420 E4	R747N1750--H0-
8200 pF	6.0	15.0	26.5	22.5	4500	420 E4	R747N1820--H0-
0.010 μF	6.0	15.0	26.5	22.5	4500	420 E4	R747N2100--H0-
0.012 μF	6.0	15.0	26.5	22.5	4500	420 E4	R747N2120--H0-
0.015 μF	6.0	15.0	26.5	22.5	4500	420 E4	R747N2150--H0-
0.018 μF	7.0	16.0	26.5	22.5	4500	420 E4	R747N2180--H0-
0.022 μF	8.5	17.0	26.5	22.5	4500	420 E4	R747N2220--H0-
0.027 μF	8.5	17.0	26.5	22.5	4500	420 E4	R747N2270--H0-
0.033 μF	10.0	18.5	26.5	22.5	4500	420 E4	R747N2330--H0-
0.039 μF	10.0	18.5	26.5	22.5	4500	420 E4	R747N2390--H0-
0.047 μF	11.0	20.0	26.5	22.5	4500	420 E4	R747N2470--H0-
0.056 μF	13.0	22.0	26.5	22.5	4500	420 E4	R747N2560--H0-
0.062 μF	13.0	22.0	26.5	22.5	4500	420 E4	R747N2620--H0-
0.068 μF	13.0	22.0	26.5	22.5	4500	420 E4	R747N2680--H0-

Mechanical version and packaging (Table1) \_\_\_\_\_  
Internal use \_\_\_\_\_  
Tolerance: J (±5%); K (±10%) \_\_\_\_\_

**METALLIZED POLYPROPYLENE FILM CAPACITOR  
A.C. APPLICATIONS**

PRODUCT CODE: R74

**ELECTRICAL CHARACTERISTICS**

**Rated voltage ( $V_R$ ):**  
500Vac (1600Vdc) - 700Vac (2000Vdc)

**Rated temperature ( $T_R$ ):** +105°C

**Temperature derated voltage:**  
for temperatures between +105°C and +125°C a decreasing factor of 1.25% per degree °C on the rated voltage  $V_R$  (a.c. and d.c.) has to be applied.

**Capacitance range:**  
680pF to 0.1 μF

**Capacitance values:**  
E12 series (IEC 60063 Norm) mainly.

**Capacitance tolerances** (measured at 1 kHz):  
±5% (J); ±10% (K).

**Total self inductance: (L)**  
(Lead length (2 mm))

Pitch (mm)	10	15	22.5
L (nH) ≈	9	10	18

**Dissipation factor (DF):**  
tgδ 10<sup>-4</sup> at +25°C ±5°C

	1kHz	10kHz	100kHz
C ≤ 2.2nF	≤ 1.0	≤ 2.0	≤ 3.0
2.2nF < C ≤ 0.027μF	≤ 1.0	≤ 2.0	≤ 8.0
0.027μF < C ≤ 0.1μF	≤ 4.0	≤ 6.0	≤ 25.0

**Insulation resistance:**

**Test conditions**  
Temperature: +25°C±5°C  
Voltage charge time: 1 min  
Voltage charge: 100Vdc

**Performance**  
≥1x10<sup>5</sup> MΩ for C≤0.33μF

**Test voltage between terminations:**  
1.6xV<sub>R</sub> applied for 2 s at 25°C±5°C

**TEST METHOD AND PERFORMANCE**

**Damp heat, steady state:**

**Test conditions**  
Temperature: +40°C±2°C  
Relative humidity (RH): 93% ±2%  
Test duration: 56 days

**Performance**  
Capacitance change |ΔC/C|: ≤2%  
DF change (Δtgδ): ≤10x10<sup>-4</sup> at 1kHz  
Insulation resistance: ≥50% of initial limit.

**Endurance:**

**Test conditions 1**  
Temperature: +125°C +0/-2°C  
Test duration: 2000 h  
Voltage applied: 0.94 x V<sub>R</sub> (a.c.) at 50Hz

**Test conditions 2**  
Temperature: +105°C ±2°C  
Test duration: 2000 h  
Voltage applied: 1.25 x V<sub>R</sub> (a.c.) at 50Hz

**Performance**  
Capacitance change |ΔC/C|: ≤5%  
DF change (Δtgδ): ≤15x10<sup>-4</sup> at 10kHz  
Insulation resistance: ≥50% of initial limit.

**Resistance to soldering heat:**

**Test conditions 1**  
Solder bath temperature: 260°C±5°C  
Dipping time (with heat screen): 10 s±1 s

**Performance**  
Capacitance change |ΔC/C|: ≤1%  
DF change (Δtgδ): ≤10x10<sup>-4</sup> at 10kHz  
Insulation resistance: ≥initial limit.

**Long term stability (after two years):**

**Storage:** standard environmental conditions (page 12).  
**Performance**  
Capacitance change |ΔC/C|: ≤0.5%

MAX. VOLTAGE (Vr.m.s.) VERSUS FREQUENCY (sinusoidal wave-form / Th ≤ 85°C)

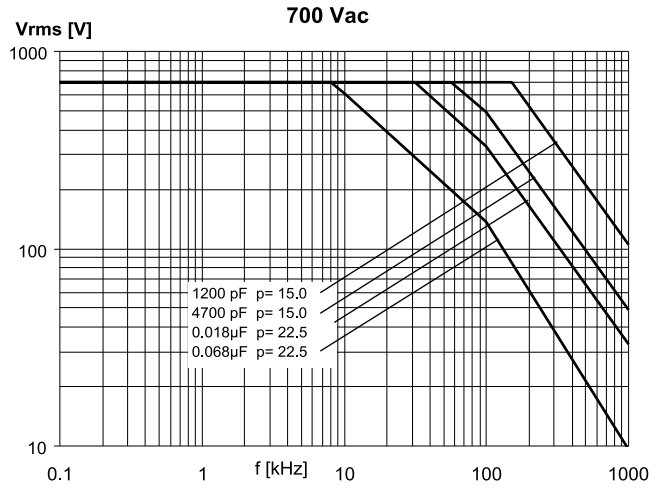
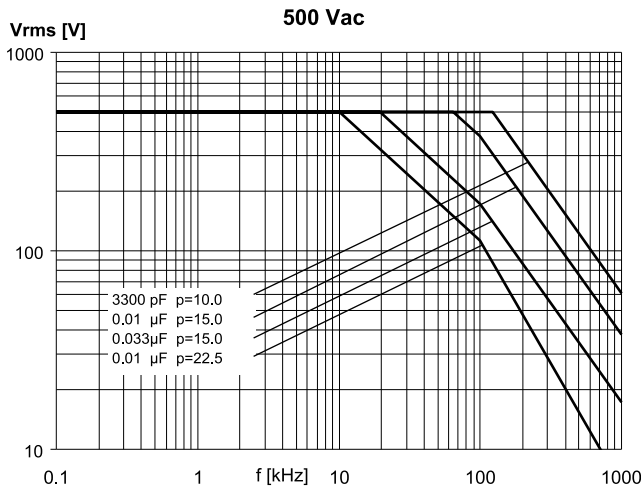

Note: p (pitch) in mm.

MAX. CURRENT ( $I_{r.m.s.}$ ) VERSUS FREQUENCY (sinusoidal wave-form /  $T_h \leq 85^\circ\text{C}$ )

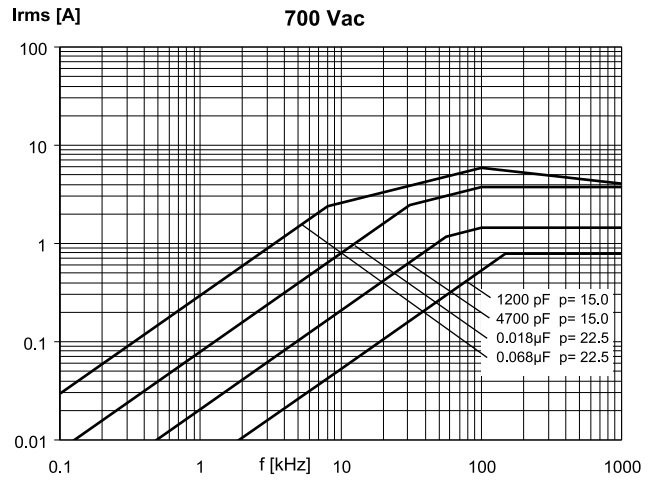
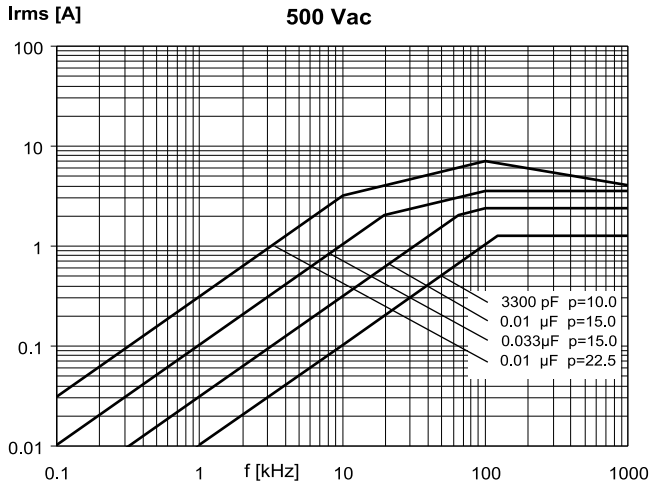

Note: p (pitch) in mm.

Statements of suitability for certain applications are based on our knowledge of typical operating conditions for such applications, but are not intended to constitute – and we specifically disclaim – any warranty concerning suitability for a specific customer application or use. This Information is intended for use only by customers who have the requisite experience and capability to determine the correct products for their application. Any technical advice inferred from this Information or otherwise provided by us with reference to the use of our products is given gratis, and we assume no obligation or liability for the advice given or results obtained.