

Chinasound SMD Piezo Transducer

CSPT09A

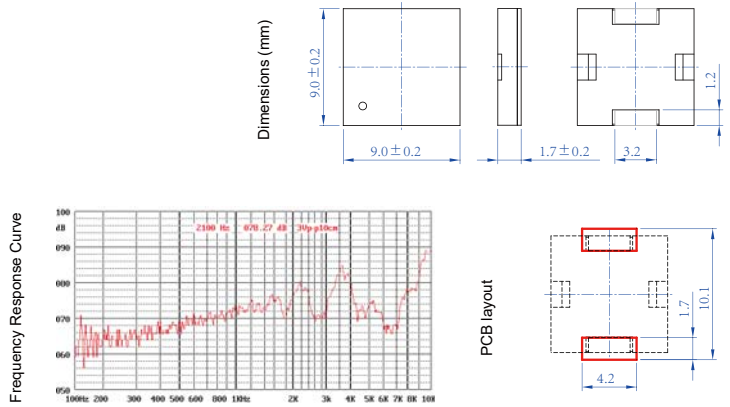

Part Number	CSPT09A03-2.1F	
Rated Voltage	(Vp-p)	3
Operating Voltage	(Vp-p)	1~20
Rated Current @3Vp-p2.1Khz	(mA)	1mA max.
Capacitance at 100Hz 1V	(pF)	15,000±30%
SPL @ 3Vp-p10cm2.1Khz	(dB)	73 min.
Resonant Frequency	(Hz)	2100±500
Operating Temperature	(°C)	-40~+105
Storage Temperature	(°C)	-40~+120
Weight	(g)	0.2



CSPT09A



Part Number	CSPT09A03-4.0F	
Rated Voltage	(Vp-p)	3
Operating Voltage	(Vp-p)	1~20
Rated Current @3Vp-p4Khz	(mA)	1mA max.
Capacitance at 100Hz 1V	(pF)	15,000±30%
SPL @ 3Vp-p10cm4Khz	(dB)	73 min.
Resonant Frequency	(Hz)	4000±500
Operating Temperature	(°C)	-40~+105
Storage Temperature	(°C)	-40~+120
Weight	(g)	0.2

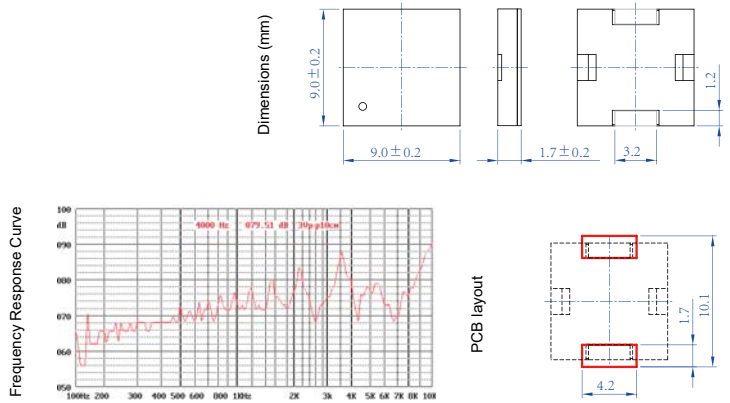

CSPT11A



Part Number	CSPT11A05-4.1F	
Rated Voltage	(Vp-p)	5
Operating Voltage	(Vp-p)	1~20
Rated Current @5Vp-p4.1Khz	(mA)	2mA max.
Capacitance at 100Hz 1V	(pF)	10000±30%
SPL @ 5Vp-p10cm4.1Khz	(dB)	73 min.
Resonant Frequency	(Hz)	4100±500
Operating Temperature	(°C)	-40~+105
Storage Temperature	(°C)	-40~+120
Weight	(g)	0.2

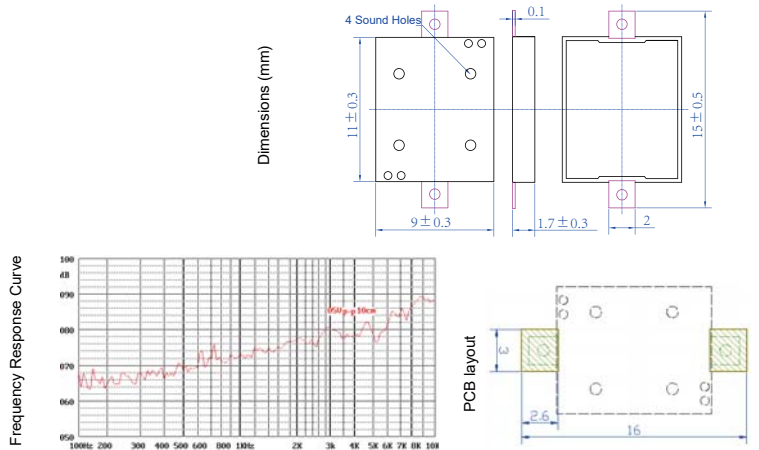

CSPT11B



Part Number	CSPT11B05-3.2F	
Rated Voltage	(Vp-p)	5
Operating Voltage	(Vp-p)	1~20
Rated Current @5Vp-p3.2Khz	(mA)	1mA max.
Capacitance at 100Hz 1V	(pF)	12000±30%
SPL @ 5Vp-p10cm3.2Khz	(dB)	75 min.
Resonant Frequency	(Hz)	3200±500
Operating Temperature	(°C)	-40~+105
Storage Temperature	(°C)	-40~+120
Weight	(g)	0.2

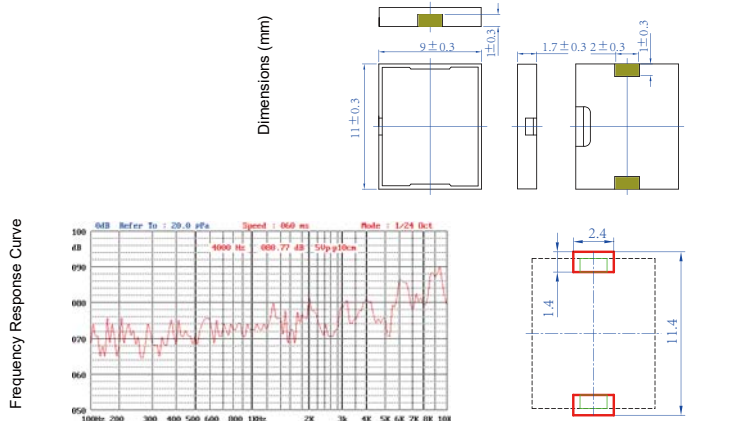

Chinasound SMD Piezo Transducer

CSPT12A

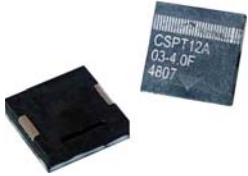

Part Number		CSPT12A03-4.0F
Rated Voltage	(Vp-p)	3
Operating Voltage	(Vp-p)	1~20
Rated Current @3Vp-p4Khz	(mA)	1 max.
Capacitance at 100Hz 1V	(pF)	15000 -30%
SPL @ 3Vp-p10cm4Khz	(dB)	75 min.
Resonant Frequency	(Hz)	4000 -500
Operating Temperature	(°C)	-40~+105
Storage Temperature	(°C)	-40~+120
Weight	(g)	0.35

Frequency Response Curve

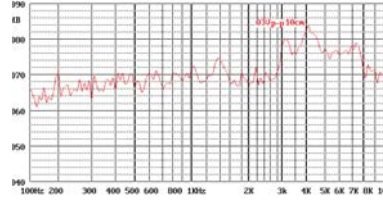

Dimensions (mm)

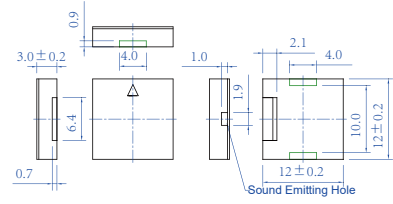

PCB layout

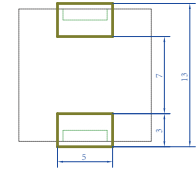

CSPT12B

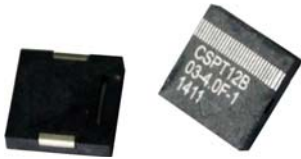

Part Number		CSPT12B03-4.0F-1
Rated Voltage	(Vp-p)	3
Operating Voltage	(Vp-p)	1~20
Rated Current @3Vp-p4Khz	(mA)	1 max.
Capacitance at 100Hz 1V	(pF)	15000 -30%
SPL @ 3Vp-p10cm4Khz	(dB)	72 min.
Resonant Frequency	(Hz)	4000 -500
Operating Temperature	(°C)	-40~+105
Storage Temperature	(°C)	-40~+120
Weight	(g)	0.35

Frequency Response Curve

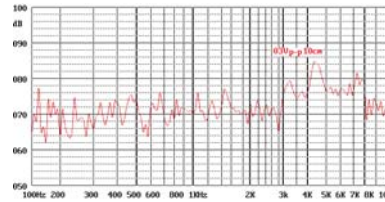

Dimensions (mm)

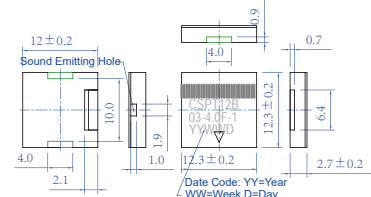

PCB layout

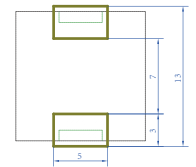

CSPT12C



Part Number		CSPT12C05-4.0F
Rated Voltage	(Vp-p)	5
Operating Voltage	(Vp-p)	1~20
Rated Current @5Vp-p4Khz	(mA)	2 max.
Capacitance at 100Hz 1V	(pF)	15000 -30%
SPL @ 5Vp-p10cm4Khz	(dB)	80 min.
Resonant Frequency	(Hz)	4000 -500
Operating Temperature	(°C)	-40~+105
Storage Temperature	(°C)	-40~+120
Weight	(g)	0.35

Frequency Response Curve

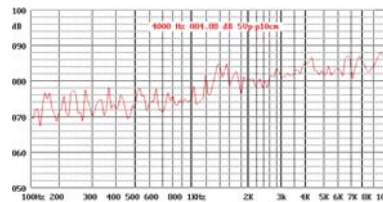

Dimensions (mm)

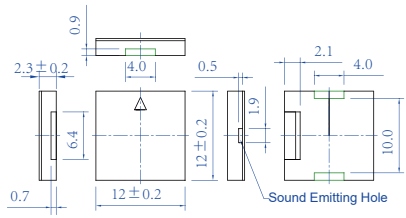

PCB layout

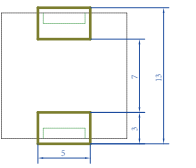

CSPT12D

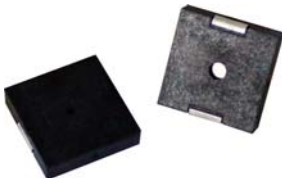

Part Number		CSPT12D05-4.0F
Rated Voltage	(Vp-p)	5
Operating Voltage	(Vp-p)	1~20
Rated Current @5Vp-p4.0Khz	(mA)	2mA max.
Capacitance at 100Hz 1V	(pF)	15000 ± 30%
SPL @ 5Vp-p10cm4.0Khz	(dB)	83 min.
Resonant Frequency	(Hz)	4100 ± 500
Operating Temperature	(°C)	-40~+105
Storage Temperature	(°C)	-40~+120
Weight	(g)	0.35

Frequency Response Curve

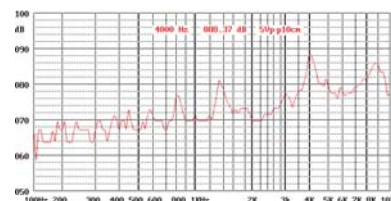

Dimensions (mm)

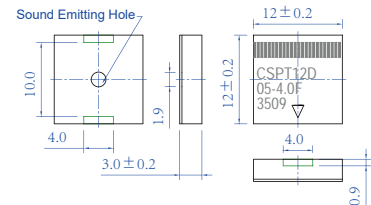

PCB layout

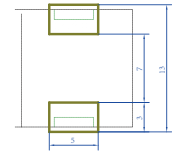

Chinasound SMD Piezo Transducer

CSPT15C

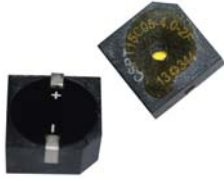

Part Number		CSPT15C05-4.0-2F
Rated Voltage	(Vp-p)	5
Operating Voltage	(Vp-p)	1~20
Rated Current @5Vp-p4Khz	(mA)	2 max.
Capacitance at 100Hz 1V	(pF)	15000±30%
SPL @ 5Vp-p10cm4Khz	(dB)	80 min.
Resonant Frequency	(Hz)	4000~500
Operating Temperature	(°C)	-30~+85
Storage Temperature	(°C)	-40~+90
Weight	(g)	1.6

Frequency Response Curve

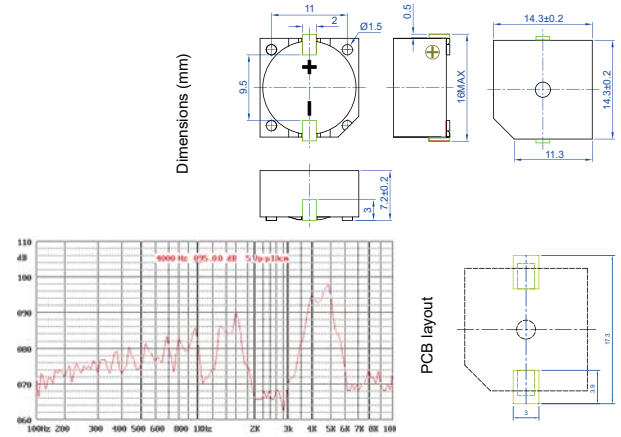

CSPT16B



Part Number		CSPT16B05-4.0F
Rated Voltage	(Vp-p)	5
Operating Voltage	(Vp-p)	1~25
Rated Current @5Vp-p4Khz	(mA)	2 max.
Capacitance at 100Hz 1V	(pF)	15000±30%
SPL @ 5Vp-p10cm4Khz	(dB)	85 min.
Resonant Frequency	(Hz)	4000±500
Operating Temperature	(°C)	-40~+105
Storage Temperature	(°C)	-40~+120
Weight	(g)	0.8

Frequency Response Curve

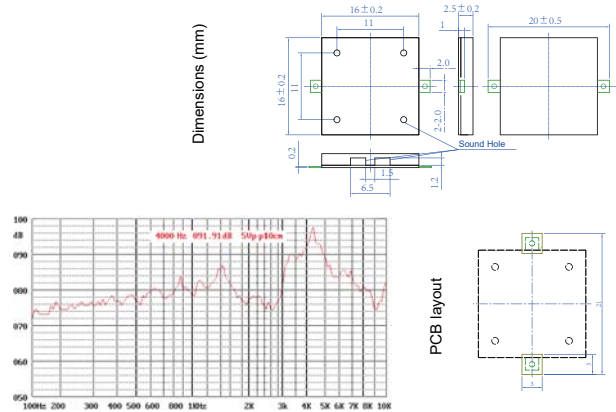

CSPT16C



Part Number		CSPT16C03-4.0F
Rated Voltage	(Vp-p)	3
Operating Voltage	(Vp-p)	1~25
Rated Current @3Vp-p4Khz	(mA)	1 max.
Capacitance at 100Hz 1V	(pF)	15000±30%
SPL @ 3Vp-p10cm4Khz	(dB)	75 min.
Resonant Frequency	(Hz)	4000±500
Operating Temperature	(°C)	-40~+105
Storage Temperature	(°C)	-40~+120
Weight	(g)	0.8

Frequency Response Curve

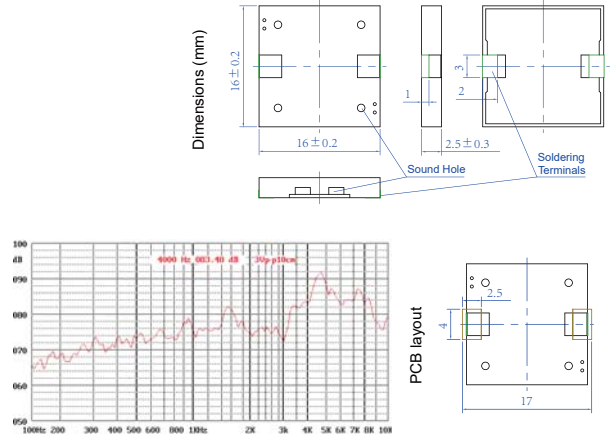

CSPT17C



Part Number		CSPT17C12-2.0F
Rated Voltage	(Vp-p)	12
Operating Voltage	(Vp-p)	1~25
Rated Current @12Vp-p2Khz	(mA)	2 max.
Capacitance at 100Hz 1V	(pF)	19000±30%
SPL @ 12Vp-p10cm2Khz	(dB)	80 min.
Resonant Frequency	(Hz)	2000~500
Operating Temperature	(°C)	-30~+85
Storage Temperature	(°C)	-40~+90
Weight	(g)	1.6

Frequency Response Curve

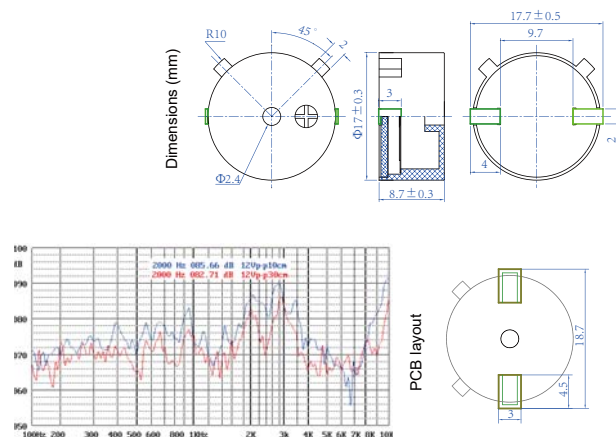

Chinasound SMD Piezo Transducer

CSPT17D



Part Number		CSPT17D12-4.0F
Rated Voltage	(Vp-p)	12
Operating Voltage	(Vp-p)	1~25
Rated Current @12Vp-p4KHz	(mA)	5 max.
Capacitance at 100Hz 1V	(pF)	15000 ±30%
SPL @ 12Vp-p10cm4KHz	(dB)	90 min.
Resonant Frequency	(Hz)	4000~500
Operating Temperature	(°C)	-30~+85
Storage Temperature	(°C)	-40~+90
Weight	(g)	1.6

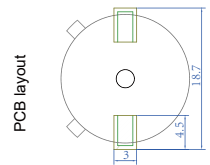
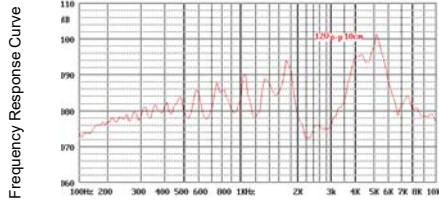
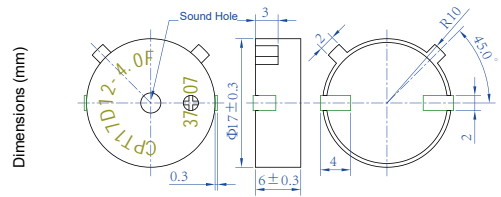

CSPT18A



Part Number		CSPT18A3.6-2.0F
Rated Voltage	(Vp-p)	3.6
Operating Voltage	(Vp-p)	1~25
Rated Current @3.6Vp-p2KHz	(mA)	1 max.
Capacitance at 100Hz 1V	(pF)	20000 ±30%
SPL @ 3.6Vp-p10cm2KHz	(dB)	74 ~ 78
Resonant Frequency	(Hz)	2000~500
Operating Temperature	(°C)	-30~+85
Storage Temperature	(°C)	-40~+90
Weight	(g)	2.0

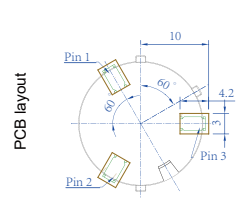
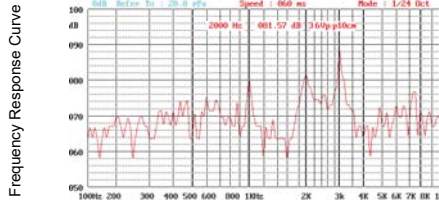
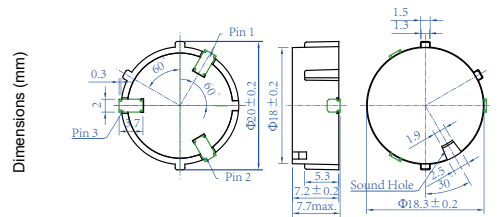

CSPT22A



Part Number		CSPT22A12-4.0F
Rated Voltage	(Vp-p)	12
Operating Voltage	(Vp-p)	1~25
Rated Current @12Vp-p4KHz	(mA)	5 max.
Capacitance at 100Hz 1V	(pF)	25000 ±30%
SPL @ 12Vp-p10cm4KHz	(dB)	90 min.
Resonant Frequency	(Hz)	4000~500
Operating Temperature	(°C)	-30~+85
Storage Temperature	(°C)	-40~+90
Weight	(g)	2.8

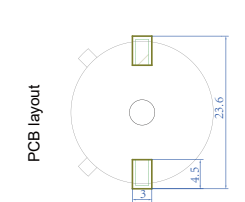
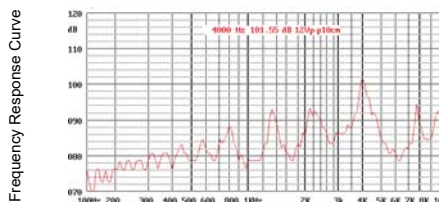
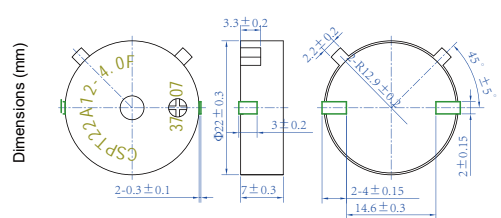

CSPT23B

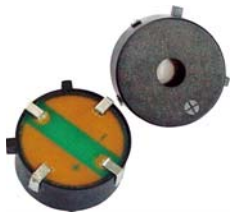

Part Number		CSPT23B09-4.0F
Rated Voltage	(Vp-p)	9
Operating Voltage	(Vp-p)	1~30
Rated Current @9Vp-p4KHz	(mA)	5 max.
Capacitance at 100Hz 1V	(pF)	25000 ±30%
SPL @ 9Vp-p10cm4KHz	(dB)	100 min.
Resonant Frequency	(Hz)	4000~500
Operating Temperature	(°C)	-30~+85
Storage Temperature	(°C)	-40~+90
Weight	(g)	3.1

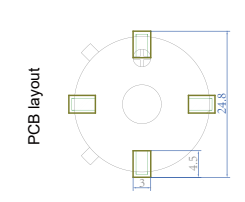
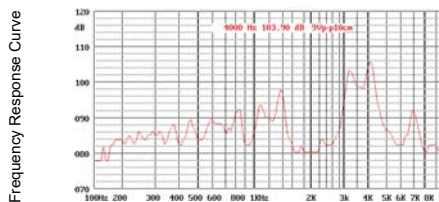
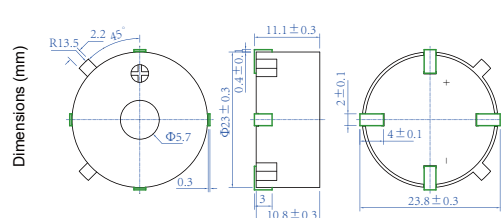

Chinasound SMD Piezo Transducer

CSPT23C



Part Number		CSPT23C09-3.2F
Rated Voltage	(Vp-p)	9
Operating Voltage	(Vp-p)	1~30
Rated Current @9Vp-p3.2Khz	(mA)	5 max.
Capacitance at 100Hz 1V	(pF)	25000±30%
SPL @ 9Vp-p10cm3.2Khz	(dB)	106 min.
Resonant Frequency	(Hz)	3200±500
Operating Temperature	(°C)	-30~+85
Storage Temperature	(°C)	-40~+90
Weight	(g)	5.35

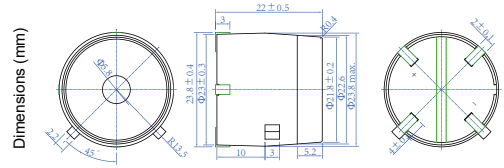

Frequency Response Curve

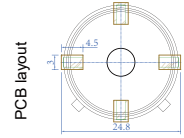
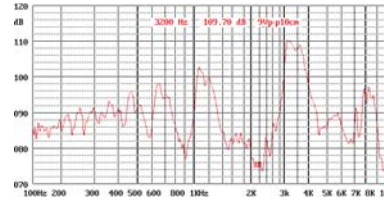

CSPT23D



Part Number		CSPT23D09-3.2F
Rated Voltage	(Vp-p)	9
Operating Voltage	(Vp-p)	1~30
Rated Current @9Vp-p3.2Khz	(mA)	5 max.
Capacitance at 100Hz 1V	(pF)	25000±30%
SPL @ 9Vp-p10cm3.2Khz	(dB)	106 min.
Resonant Frequency	(Hz)	3200±500
Operating Temperature	(°C)	-30~+85
Storage Temperature	(°C)	-40~+90
Weight	(g)	5.35

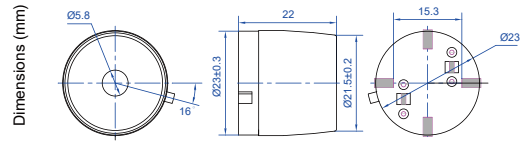

Frequency Response Curve

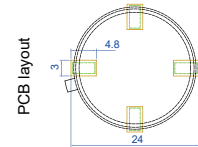
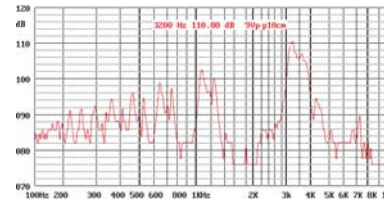

CSPF23D

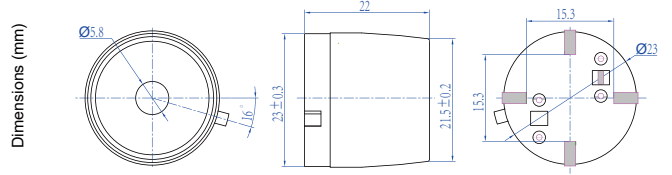

Part Number		CSPF23D09-3.2F
Rated Voltage @ 9VDC	(VDC)	9
Operating Voltage	(VDC)	6~18
Rated Current	(mA)	10 max.
Sound Output @ 9VDC10cm	(dB)	106 min.
Resonant Frequency	(Hz)	3200±500
Capacitance at 100Hz 1V	(pF)	25000±30%
Operating Temperature	(°C)	-30~+85
Storage Temperature	(°C)	-40~+90
Weight	(g)	5.4

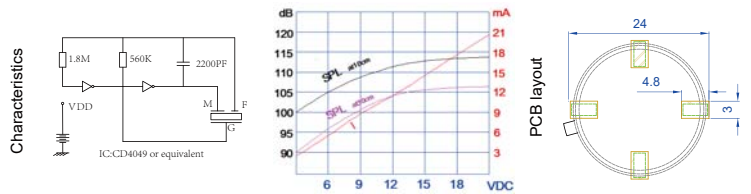

Chinasound SMD Piezo Buzzer

CSPB15A



Part Number		CSPB15A05-4.0F
*Rated Voltage	(VDC)	5
Operating Voltage	(VDC)	3~16
♦Rated Current	(mA)	8 max.
♦Sound Output at 10cm	(dB)	85min.
Resonant Frequency	(Hz)	4,000+/-500
Operating Temperature	(°C)	-40~+85
Storage Temperature	(°C)	-40~+90
Weight	(g)	1.6
*Other Rated Voltage is available ♦Value applying at rated voltage, rated frequency		

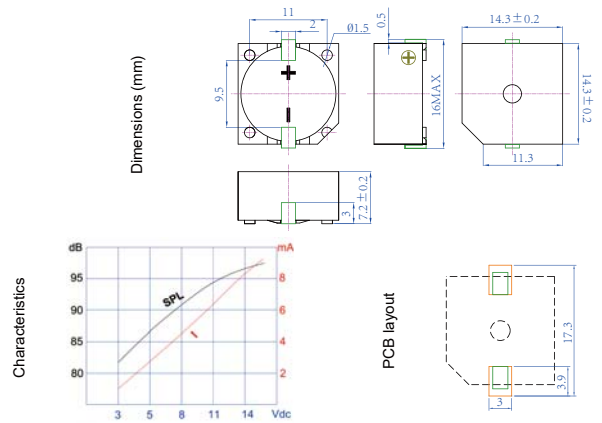

CSPB15B



Part Number		CSPB15B12-4.0F
*Rated Voltage	(Vdc)	12
Operating Voltage	(Vdc)	3~16
♦Rated Current	(mA)	8 max.
♦Sound Output at 10cm	(dB)	90 min.
Resonant Frequency	(Hz)	4,000+/-500
Operating Temperature	(°C)	-40~+85
Storage Temperature	(°C)	-40~+90
Weight	(g)	1.6
*Other Rated Voltage is available ♦Value applying at rated voltage, rated frequency		

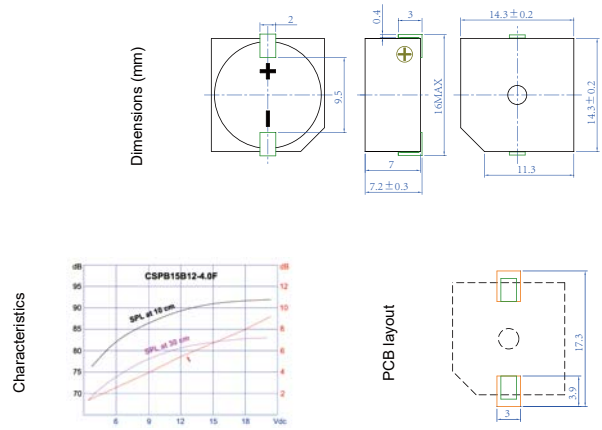

CSPB23B

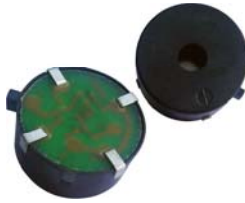

Part Number		CSPB23B09-3.2F
*Rated Voltage	(Vdc)	9
Operating Voltage	(Vdc)	6~18
♦Rated Current	(mA)	10max.
♦Sound Output at 10cm	(dB)	90min.
Resonant Frequency	(Hz)	3,200+/-500
Operating Temperature	(°C)	-40~+85
Storage Temperature	(°C)	-40~+90
Weight	(g)	3.4
*Other Rated Voltage is available ♦Value applying at rated voltage, rated frequency		

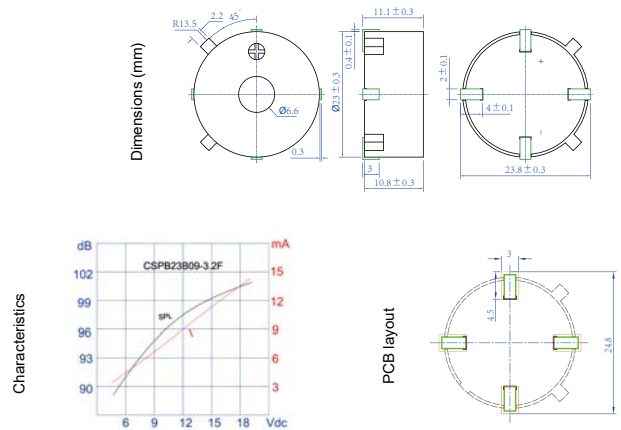

CSPB23C



Part Number		CSPB23C09-3.2F
*Rated Voltage	(Vdc)	9
Operating Voltage	(Vdc)	6~18
♦Rated Current	(mA)	10 max.
♦Sound Output at 10cm	(dB)	95 min.
Resonant Frequency	(Hz)	3,200 +/-500
Operating Temperature	(°C)	-40 ~+85
Storage Temperature	(°C)	-40~+90
Weight	(g)	5.66
*Other Rated Voltage is available ♦Value applying at rated voltage, rated frequency		

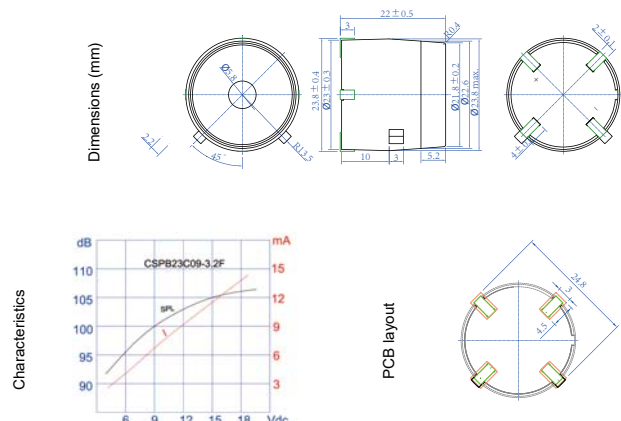

Chinasound SMD Micro Speaker

CSMS13S4

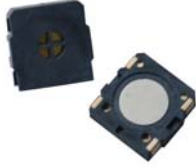

Part Number		CSMS13S4-8S0.3-P950F
Rated Impedance	(ohm)	8 ± 15%
Rated (Max.) Power	(W)	0.3 (0.5)
Resonance Frequency	(Hz)	950 ± 20%
Rated Frequency Range	(Hz)	fo~20000
◆ Sound Pressure Level	(dB)	87 ± 3 at 0.1m0.3W
Operating Temperature	(°C)	-40~+85
Storage Temperature	(°C)	-40~+90
Weight	(g)	1.1

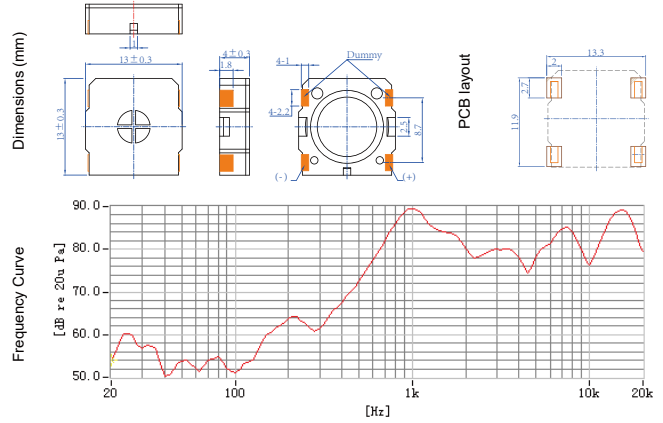

CSMS15S4

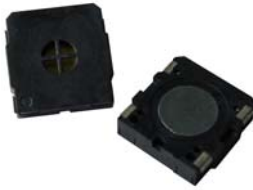

Part Number		CSMS15S4-8S0.3-P800F
Rated Impedance	(ohm)	8 ± 15%
Rated (Max.) Power	(W)	0.3 (0.5)
Resonance Frequency	(Hz)	800 ± 20%
Rated Frequency Range	(Hz)	fo~20000
◆ Sound Pressure Level	(dB)	88 ± 3 at 0.1m0.3W
Operating Temperature	(°C)	-40~+80
Storage Temperature	(°C)	-40~+90
Weight	(g)	1.3

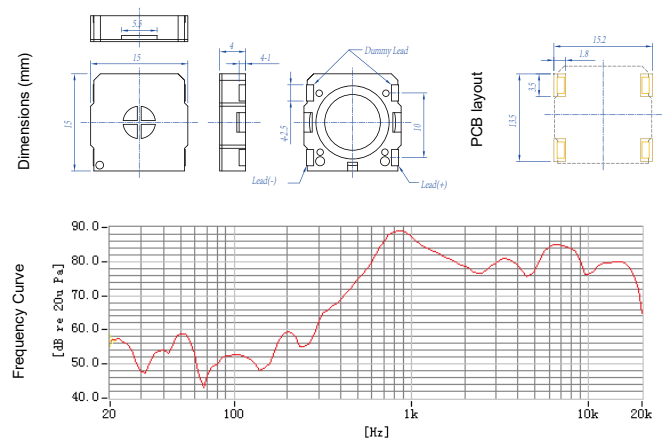

CSMS15S4.3

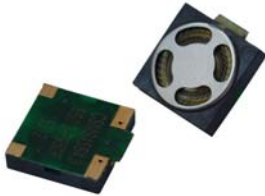

Part Number		CSMS15S4.3-8S0.3-P950F
Rated Impedance	(ohm)	8 ± 15%
Rated (Max.) Power	(W)	0.3 (0.5)
Resonance Frequency	(Hz)	950 ± 20%
Rated Frequency Range	(Hz)	fo~20000
◆ Sound Pressure Level	(dB)	89 ± 3 at 0.1m0.3W
Operating Temperature	(°C)	-40~+80
Storage Temperature	(°C)	-40~+90
Weight	(g)	2.0

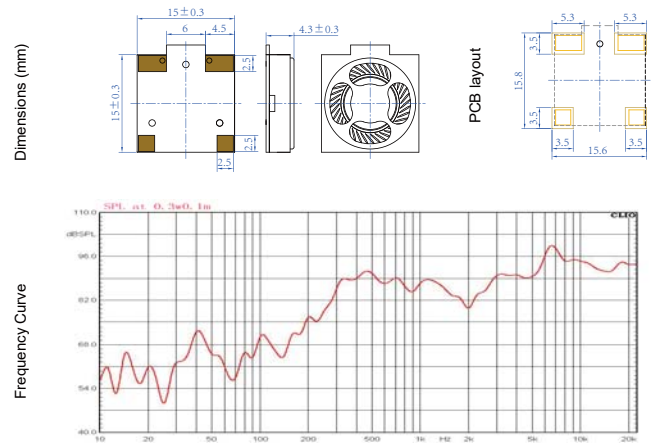

CSMS18S4.8

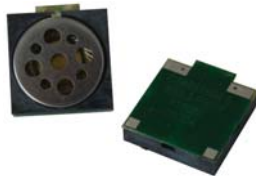

Part Number		CSMS18S4.8-8S0.3-P500F
Rated Impedance	(ohm)	8 ± 15%
Rated (Max.) Power	(W)	0.3 (0.5)
Resonance Frequency	(Hz)	500 ± 20%
Rated Frequency Range	(Hz)	fo~20000
◆ Sound Pressure Level	(dB)	89 ± 3 at 0.1m0.3W
Operating Temperature	(°C)	-40~+85
Storage Temperature	(°C)	-40~+90
Weight	(g)	2.65

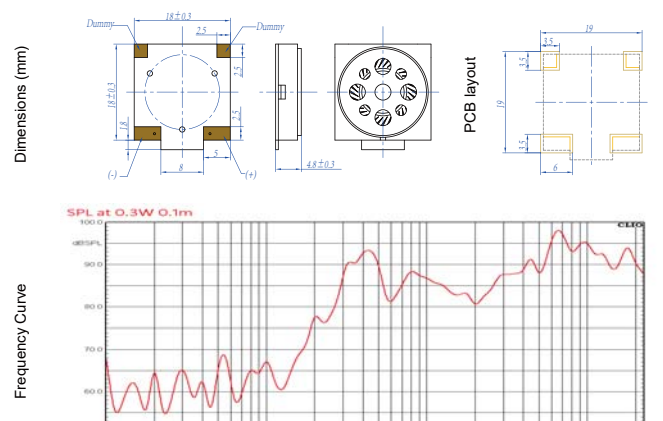

Average of SPL values at 800, 1000, 1200 & 1500 Hz.