

FMP20N60S1

FUJI POWER MOSFET

Super J-MOS series

N-Channel enhancement mode power MOSFET

■ Features

- Low on-state resistance
- Low switching loss
- easy to use (more controllable switching dV/dt by R_g)

■ Applications

- UPS
- Server
- Telecom
- Power conditioner system
- Power supply

■ Outline Drawings [mm]

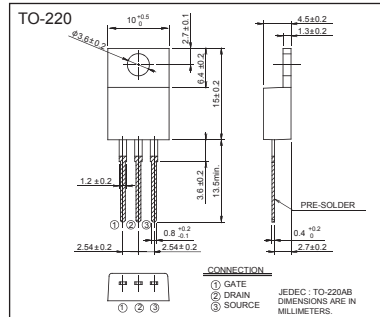

■ Equivalent circuit schematic

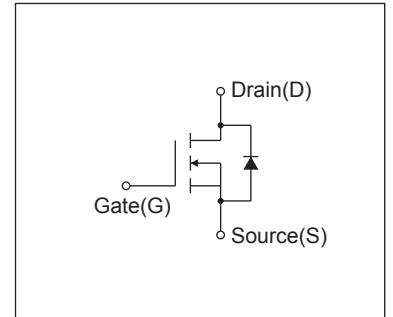

■ Maximum Ratings and Characteristics

● Absolute Maximum Ratings at T_c=25°C (unless otherwise specified)

Description	Symbol	Characteristics	Unit	Remarks
Drain-Source Voltage	V _{DS}	600	V	
	V _{DSX}	600	V	V _{GS} =-30V
Continuous Drain Current	I _D	±20	A	T _c =25°C Note*1
		±12.6	A	T _c =100°C Note*1
Pulsed Drain Current	I _{DP}	±60	A	
Gate-Source Voltage	V _{GS}	±30	V	
Repetitive and Non-Repetitive Maximum Avalanche Current	I _{AR}	6.6	A	Note *2
Non-Repetitive Maximum Avalanche Energy	E _{AS}	472.2	mJ	Note *3
Maximum Drain-Source dV/dt	dV _{DS} /dt	50	kV/μs	V _{DS} ≤ 600V
Peak Diode Recovery dV/dt	dV/dt	15	kV/μs	Note *4
Peak Diode Recovery -di/dt	-di/dt	100	A/μs	Note *5
Maximum Power Dissipation	P _D	2.02	W	T _a =25°C
		150		T _c =25°C
Operating and Storage Temperature range	T _{ch}	150	°C	
	T _{stg}	-55 to +150	°C	

Note *1 : Limited by maximum channel temperature.

Note *2 : T_{ch}≤150°C, See Fig.1 and Fig.2

Note *3 : Starting T_{ch}=25°C, I_{AS}=2A, L=216mH, V_{DD}=60V, R_G=50Ω, See Fig.1 and Fig.2

E_{AS} limited by maximum channel temperature and avalanche current.

Note *4 : I_F≤-I_D, -di/dt=100A/μs, V_{DD}≤400V, T_{ch}≤150°C.

Note *5 : I_F≤-I_D, dV/dt=15kV/μs, V_{DD}≤400V, T_{ch}≤150°C.

● Electrical Characteristics at T_c=25°C (unless otherwise specified)
Static Ratings

Description	Symbol	Conditions	min.	typ.	max.	Unit
Drain-Source Breakdown Voltage	BV _{DSS}	I _D =250μA V _{GS} =0V	600	-	-	V
Gate Threshold Voltage	V _{GS(th)}	I _D =250μA V _{DS} =V _{GS}	2.5	3	3.5	V
Zero Gate Voltage Drain Current	I _{DSS}	V _{DS} =600V V _{GS} =0V T _{ch} =25°C	-	-	25	μA
		V _{DS} =480V V _{GS} =0V T _{ch} =125°C	-	-	250	
Gate-Source Leakage Current	I _{GSS}	V _{GS} = ± 30V V _{DS} =0V	-	10	100	nA
Drain-Source On-State Resistance	R _{DS(on)}	I _D =10A V _{GS} =10V	-	0.161	0.19	Ω
Gate resistance	R _G	f=1MHz, open drain	-	3.7	-	Ω
Forward Transconductance	g _{fs}	I _D =10A V _{DS} =25V	8.5	17.5	-	S
Input Capacitance	C _{iss}	V _{DS} =10V	-	1470	-	pF
Output Capacitance	C _{oss}	V _{GS} =0V	-	3120	-	
Reverse Transfer Capacitance	C _{rss}	f=1MHz	-	280	-	
Effective output capacitance, energy related (Note *6)	C _{o(er)}	V _{GS} =0V V _{DS} =0...480V	-	90	-	
Effective output capacitance, time related (Note *7)	C _{o(tr)}	V _{GS} =0V V _{DS} =0...480V I _D =constant	-	305	-	
Turn-On Time	t _{d(on)}	V _{DD} =400V, V _{GS} =10V I _D =10A, R _G =27Ω	-	22	-	ns
	t _r		-	40	-	
Turn-Off Time	t _{d(off)}	See Fig.3 and Fig.4	-	162	-	
	t _f		-	22	-	
Total Gate Charge	Q _G	V _{DD} =480V, I _D =20A V _{GS} =10V See Fig.5	-	48	-	nC
Gate-Source Charge	Q _{GS}		-	12.5	-	
Gate-Drain Charge	Q _{GD}		-	15	-	
Drain-Source crossover Charge	Q _{SW}		-	8	-	
Avalanche Capability	I _{AV}	L=6.02mH, T _{ch} =25°C See Fig.1 and Fig.2	6.6	-	-	A
Diode Forward On-Voltage	V _{SD}	I _F =20A, V _{GS} =0V T _{ch} =25°C	-	0.9	1.35	V
Reverse Recovery Time	t _{rr}	I _F =20A, V _{GS} =0V V _{DD} =400V		370	-	ns
Reverse Recovery Charge	Q _{rr}	-di/dt=100A/μs T _{ch} =25°C	-	6.2	-	μC
Peak Reverse Recovery Current	I _{rp}	See Fig.6	-	32	-	A

Note *6 : C_{o(er)} is a fixed capacitance that gives the same stored energy as C_{oss} while V_{DS} is rising from 0 to 80% BV_{DSS}.

Note *7 : C_{o(tr)} is a fixed capacitance that gives the same charging times as C_{oss} while V_{DS} is rising from 0 to 80% BV_{DSS}.

● Thermal Characteristics

Description	Symbol	min.	typ.	max.	Unit
Channel to Case	R _{th(ch-c)}			0.83	°C/W
Channel to Ambient	R _{th(ch-a)}			62	°C/W

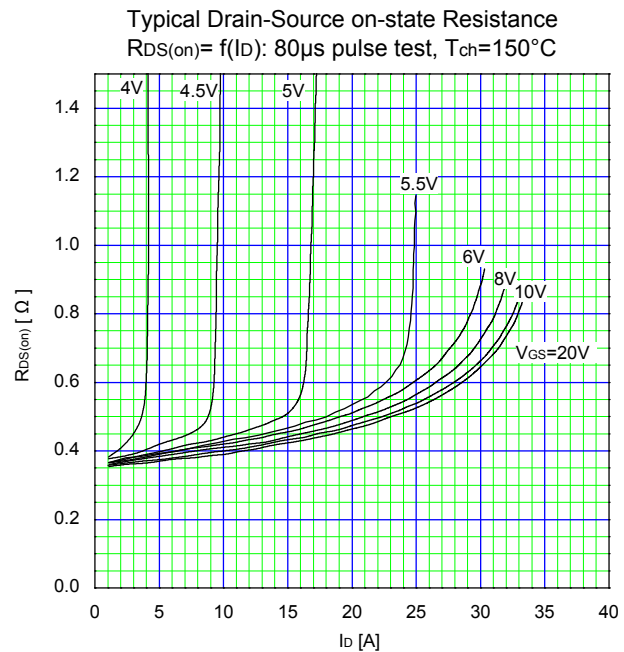
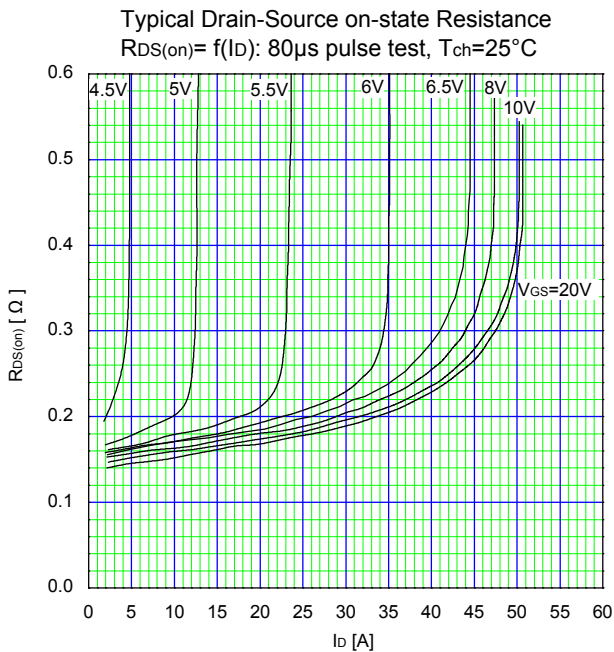
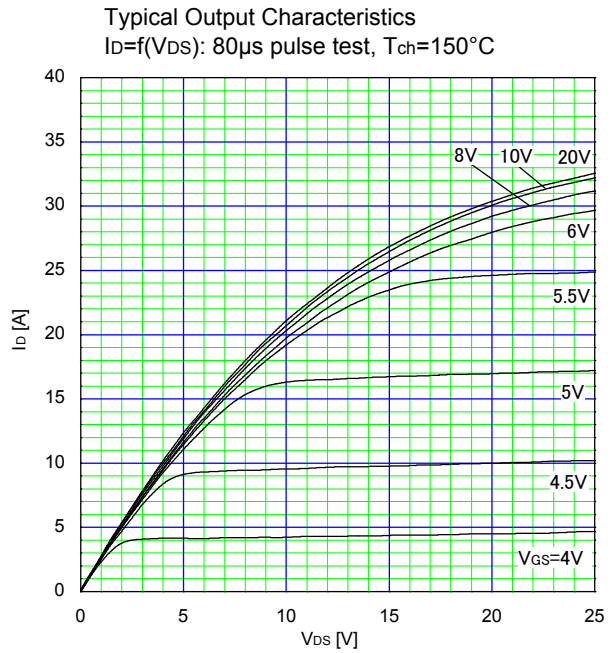
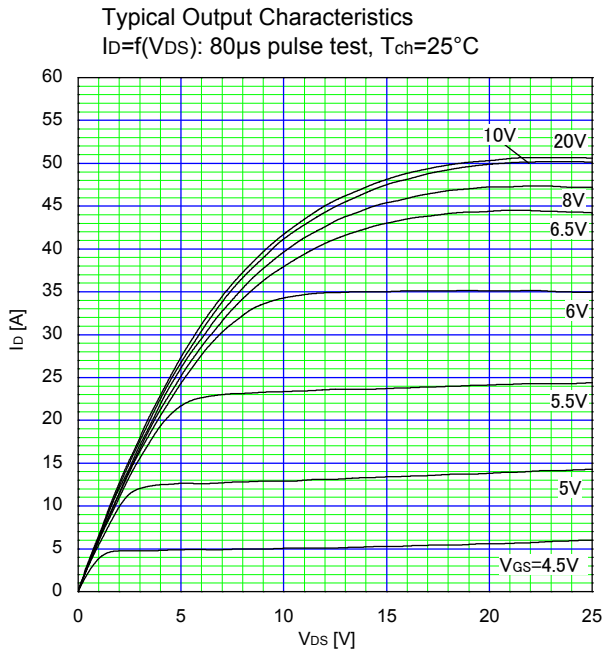
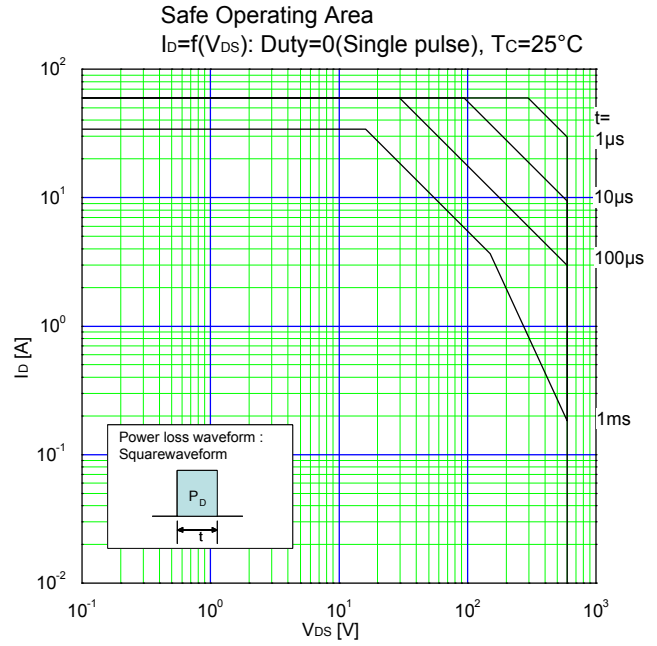
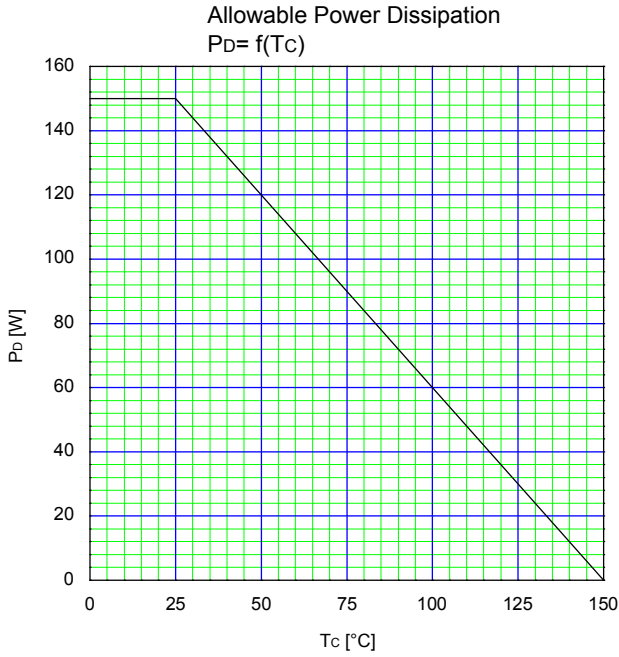

Drain-Source On-state Resistance
 $R_{DS(on)} = f(T_{ch})$: $I_D=10A, V_{GS}=10V$

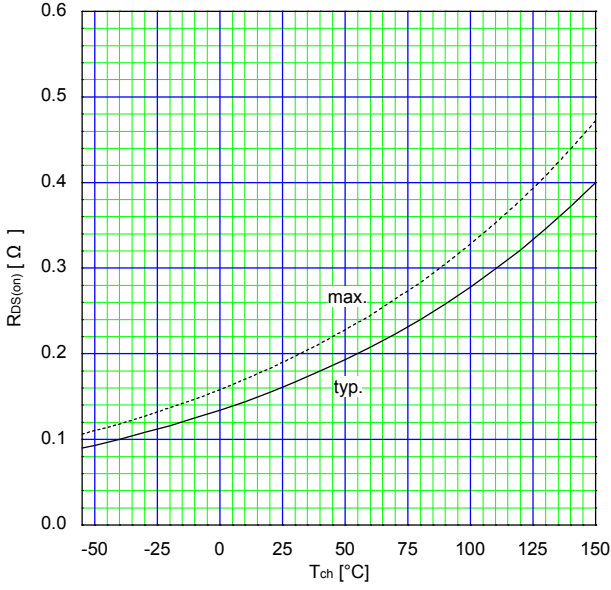

Gate Threshold Voltage vs. T_{ch}
 $V_{GS(th)} = f(T_{ch})$: $V_{DS} = V_{GS}, I_D = 250\mu A$

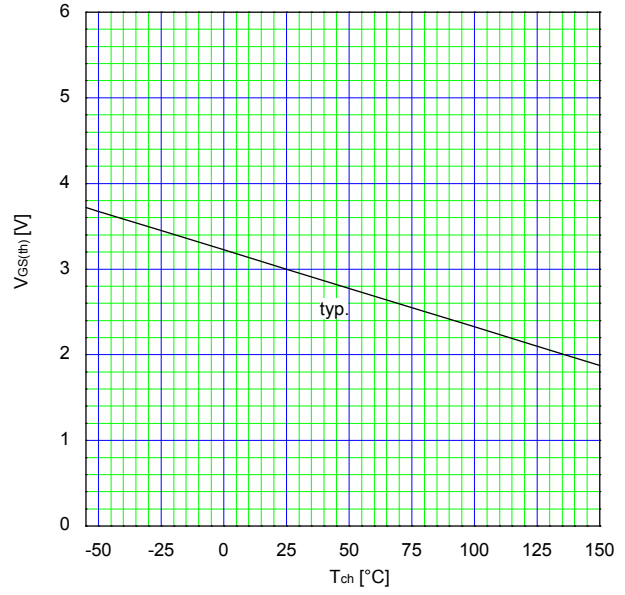

Typical Transfer Characteristic
 $I_D = f(V_{GS})$: 80μs pulse test, $V_{DS}=25V$

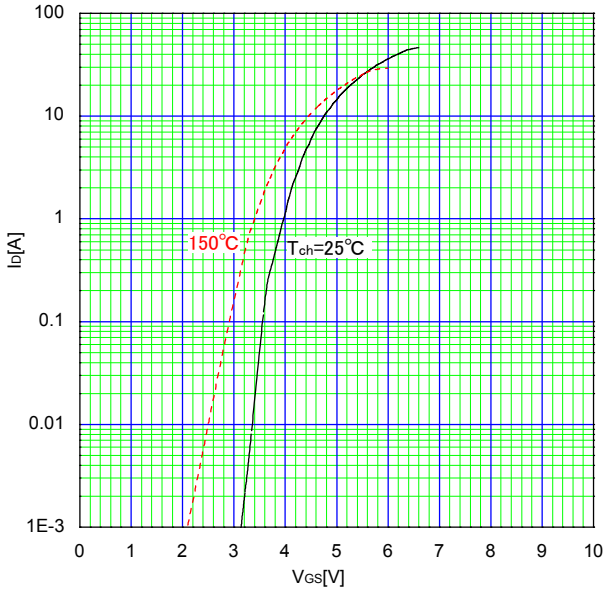

Typical Transconductance
 $g_{fs} = f(I_D)$: 80μs pulse test, $V_{DS}=25V$

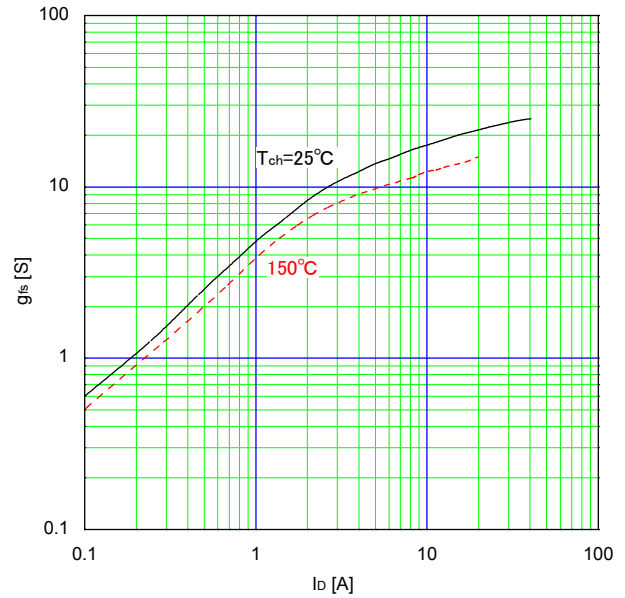

Typical Forward Characteristics of Reverse Diode
 $I_F = f(V_{SD})$: 80μs pulse test

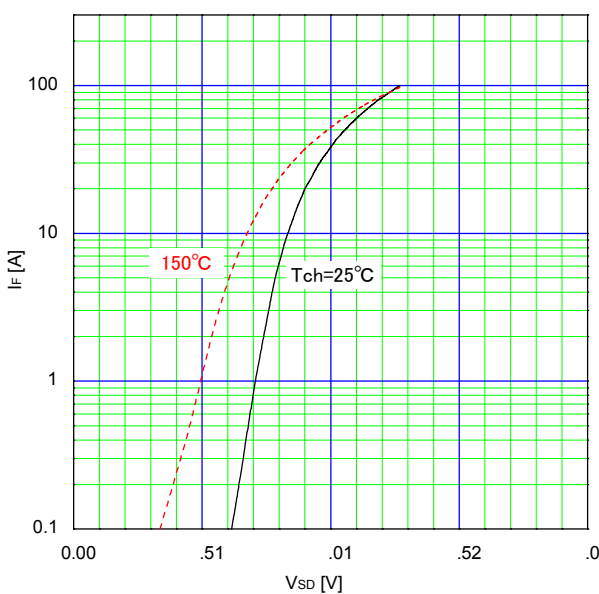

Typical Capacitance
 $C = f(V_{DS})$: $V_{GS}=0V, f=1MHz$

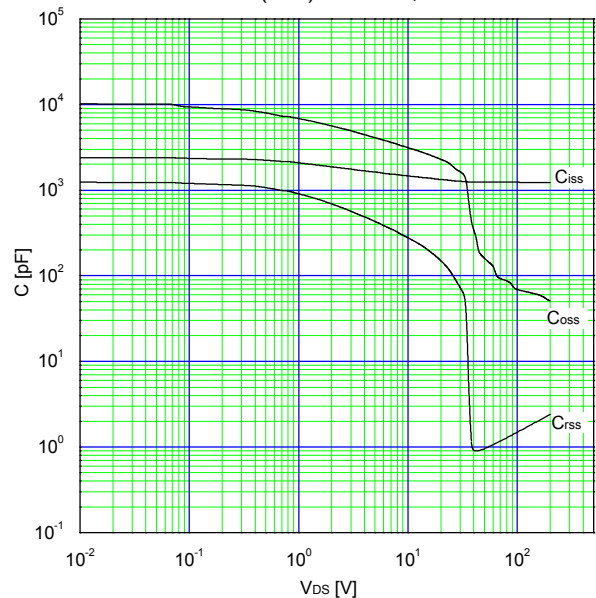

Typical Coss stored energy

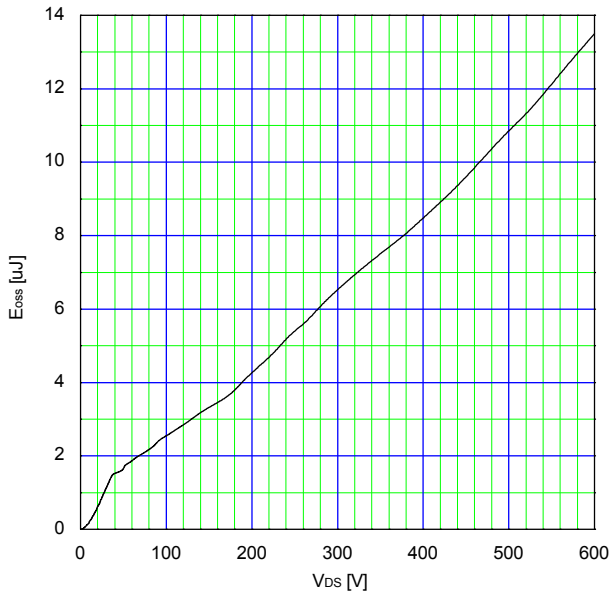

Typical Switching Characteristics vs. I_D $T_{ch}=25$
 $t = f(I_D)$: $V_{dd}=400V, V_{GS}=10V/0V, R_G=27\Omega, L=500\mu H$

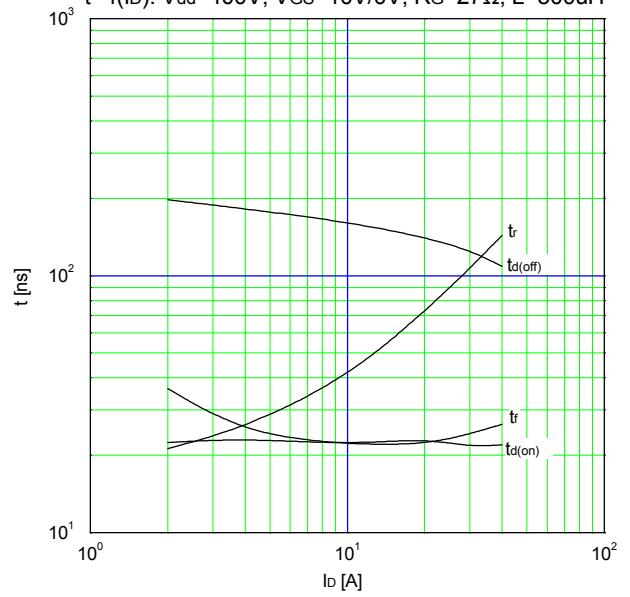

Typical Gate Charge Characteristics
 $V_{GS} = f(Q_g)$: $I_D=20A, V_{dd}=480V, T_{ch}=25^\circ C$

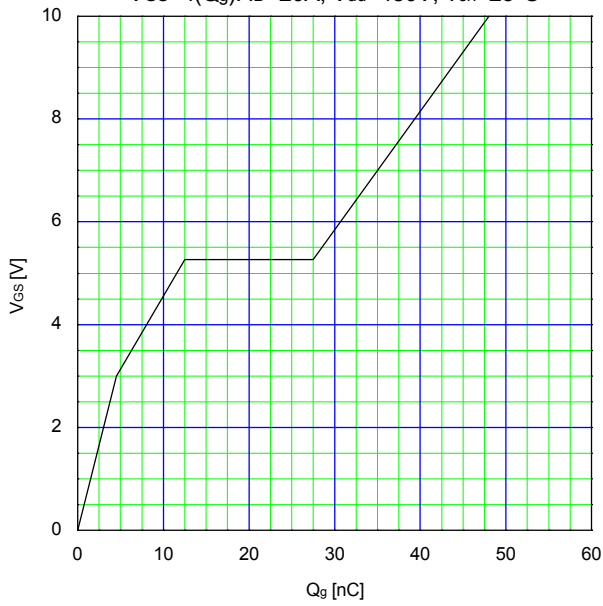

Maximum Avalanche Energy vs. starting T_{ch}
 $E_{AV} = f(\text{starting } T_{ch})$: $V_{CC}=60V, I_{(AV)} \leq 6.6A$

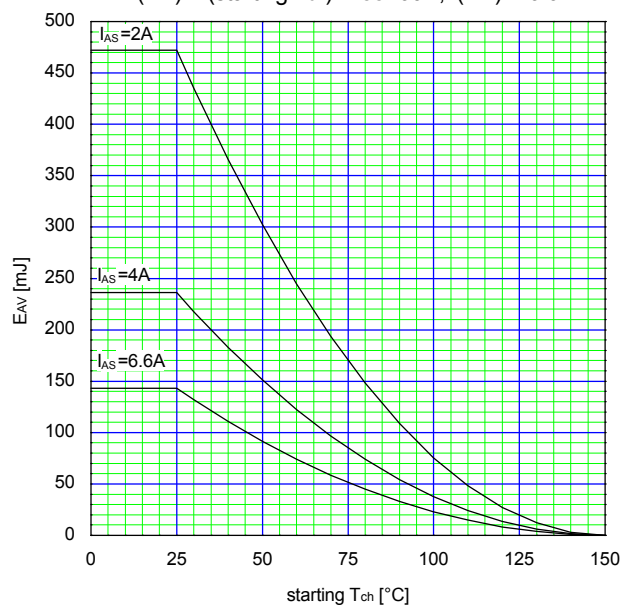

Transient Thermal Impedance
 $Z_{th(ch-c)} = f(t)$: $D=0$

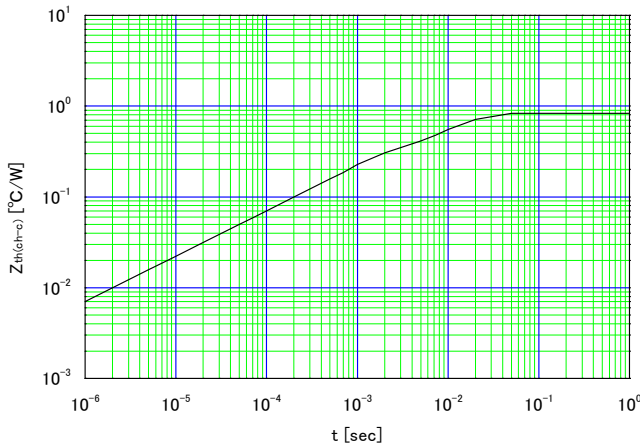

■ Outview: TO-220 Package

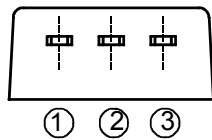
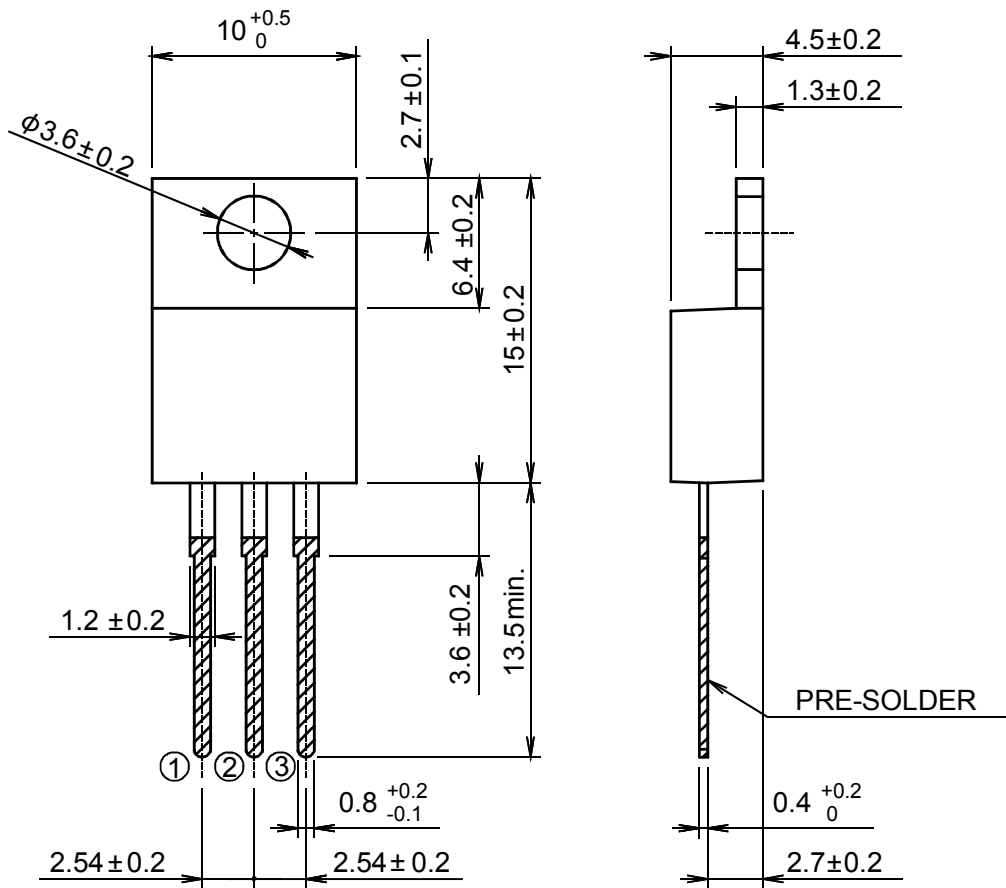

CONNECTION

- ① GATE
- ② DRAIN
- ③ SOURCE

JEDEC : TO-220AB
 DIMENSIONS ARE IN MILLIMETERS.

■ Marking

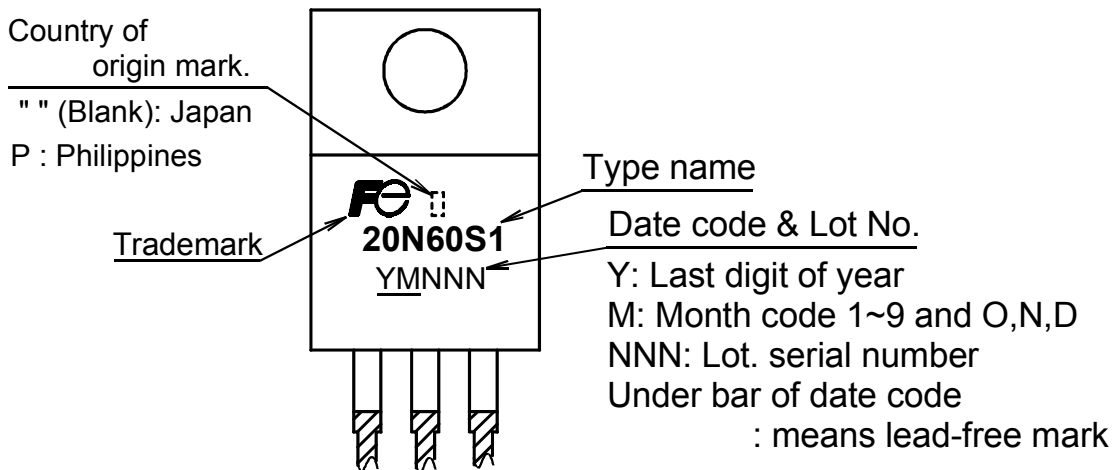

* The font (font type,size) and the trademark-size might be actually different.

WARNING

1. This Catalog contains the product specifications, characteristics, data, materials, and structures as of February 2012. The contents are subject to change without notice for specification changes or other reasons. When using a product listed in this Catalog, be sur to obtain the latest specifications.
2. All applications described in this Catalog exemplify the use of Fuji's products for your reference only. No right or license, either express or implied, under any patent, copyright, trade secret or other intellectual property right owned by Fuji Electric Co., Ltd. is (or shall be deemed) granted. Fuji Electric Co., Ltd. makes no representation or warranty, whether express or implied, relating to the infringement or alleged infringement of other's intellectual property rights which may arise from the use of the applications described herein.
3. Although Fuji Electric Co., Ltd. is enhancing product quality and reliability, a small percentage of semiconductor products may become faulty. When using Fuji Electric semiconductor products in your equipment, you are requested to take adequate safety measures to prevent the equipment from causing a physical injury, fire, or other problem if any of the products become faulty. It is recommended to make your design failsafe, flame retardant, and free of malfunction.
4. The products introduced in this Catalog are intended for use in the following electronic and electrical equipment which has normal reliability requirements.
 - Computers
 - OA equipment
 - Communications equipment (terminal devices)
 - Measurement equipment
 - Machine tools
 - Audiovisual equipment
 - Electrical home appliances
 - Personal equipment
 - Industrial robots etc.
5. If you need to use a product in this Catalog for equipment requiring higher reliability than normal, such as for the equipment listed below, it is imperative to contact Fuji Electric Co., Ltd. to obtain prior approval. When using these products for such equipment, take adequate measures such as a backup system to prevent the equipment from malfunctioning even if a Fuji's product incorporated in the equipment becomes faulty.
 - Transportation equipment (mounted on cars and ships)
 - Trunk communications equipment
 - Traffic-signal control equipment
 - Gas leakage detectors with an auto-shut-off feature
 - Emergency equipment for responding to disasters and anti-burglary devices
 - Safety devices
 - Medical equipment
6. Do not use products in this Catalog for the equipment requiring strict reliability such as the following and equivalents to strategic equipment (without limitation).
 - Space equipment
 - Aeronautic equipment
 - Nuclear control equipment
 - Submarine repeater equipment
7. Copyright ©1996-2011 by Fuji Electric Co., Ltd. All rights reserved.
No part of this Catalog may be reproduced in any form or by any means without the express permission of Fuji Electric Co., Ltd.
8. If you have any question about any portion in this Catalog, ask Fuji Electric Co., Ltd. or its sales agents before using the product. Neither Fuji Electric Co., Ltd. nor its agents shall be liable for any injury caused by any use of the products not in accordance with instructions set forth herein.