

## Super LLD II (For PFC circuit) (current discontinuous mode)

### LOW LOSS SUPER HIGH SPEED RECTIFIER

#### Outline drawings, mm

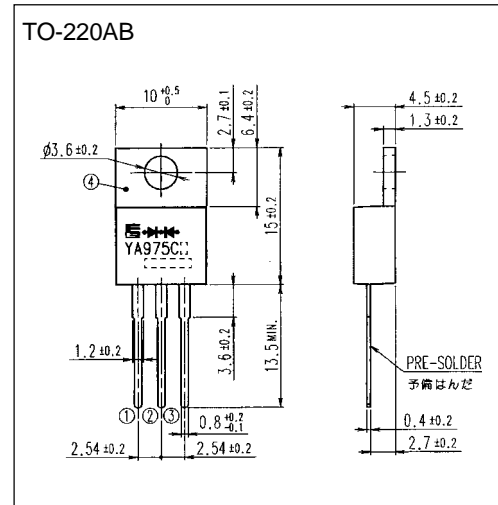

#### Features

- Super high speed switching
- High reliability by planer design

#### Applications

- PFC circuit (current continuous mode)

#### Connection diagram

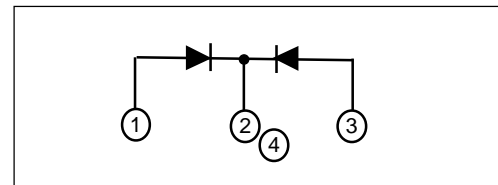

#### Maximum ratings and characteristics

##### Maximum ratings

Item	Symbol	Conditions	Rating	Unit
Repetitive peak reverse voltage	$V_{RRM}$		600	V
Average output current	$I_o$	Square wave duty=1/2, $T_c=106^\circ\text{C}$	20 *	A
Non-Repetitive surge current	$I_{FSM}$	Sine wave 10ms, 1shot	100	A
Operating junction temperature	$T_j$		150	$^\circ\text{C}$
Storage temperature	$T_{stg}$		-40 to +150	$^\circ\text{C}$

\* Out put current of centertap full wave connection.

##### Electrical characteristics ( $T_a=25^\circ\text{C}$ Unless otherwise specified)

Item	Symbol	Conditions	Characteristics	Unit
Forward voltage	$V_F$	$I_F=10\text{A}$	Max. 1.55	V
Reverse current	$I_R$	$V_R=V_{RRM}$	Max. 10.0	$\mu\text{A}$
Reverse recovery time	$t_{rr}$	$I_F=0.1\text{A}$ , $I_R=0.2\text{A}$ , $I_{rec}=0.05\text{A}$	Max. 50.0	ns
Thermal resistance	$R_{th(j-c)}$	Junction to case	Max. 1.25	$^\circ\text{C/W}$

\*\* Rating per element

##### Mechanical characteristics

Mounting torque	Recommended torque	0.3 to 0.5	N·m
Approximate mass		2.0	g

■ Characteristics

Forward Characteristic (typ.)

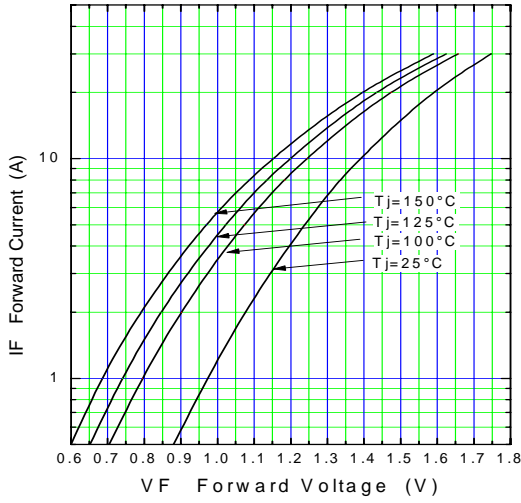

Reverse Characteristic (typ.)

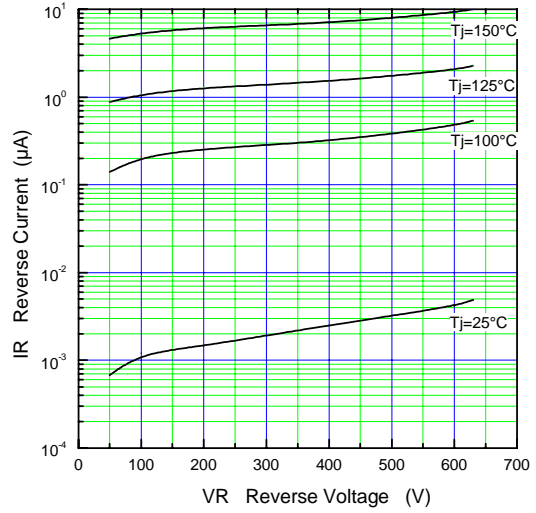

Forward Power Dissipation (max.)

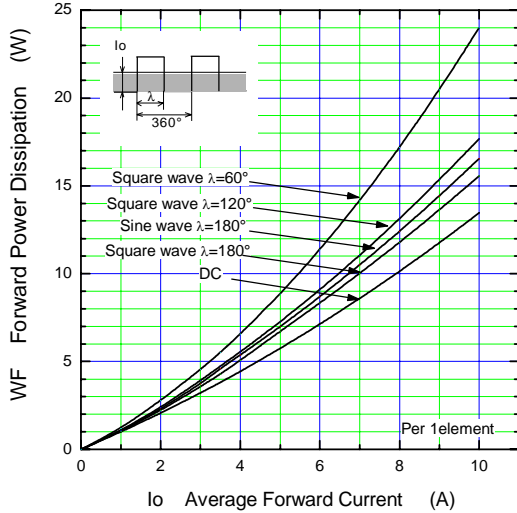

Reverse Power Dissipation (max.)

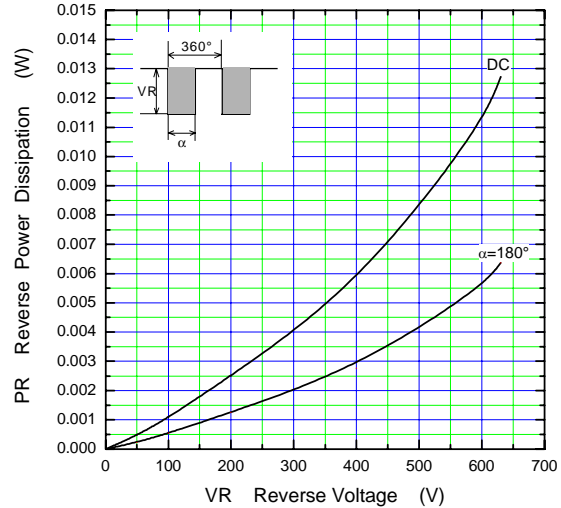

Current Derating (I<sub>o</sub>-T<sub>c</sub>) (max.)

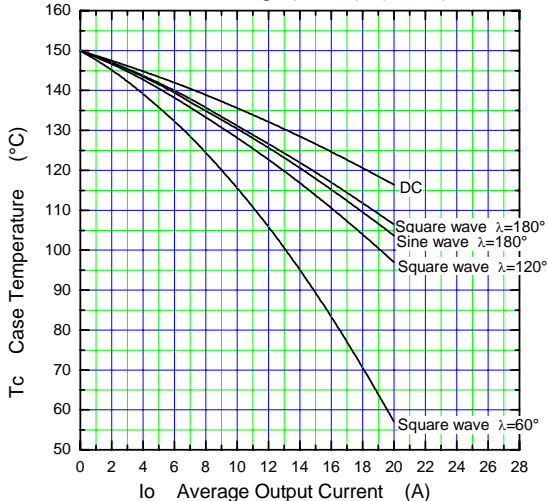

Junction Capacitance Characteristic (typ.)

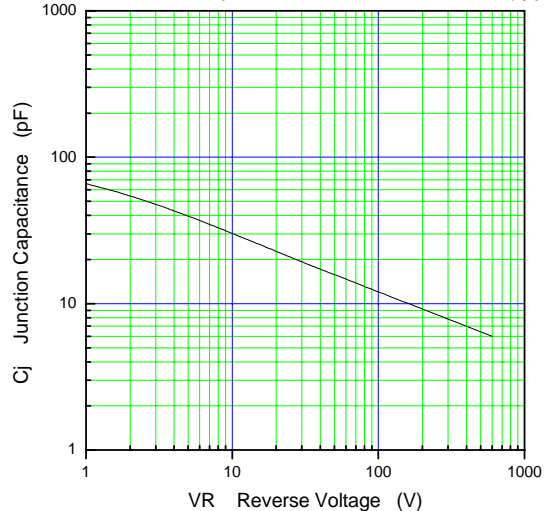

λ: Conduction angle of forward current for each rectifier element  
I<sub>o</sub>: Output current of center-tap full wave connection

