

SOT-23 Plastic-Encapsulate Transistors

MMBT3904 TRANSISTOR (NPN)

FEATURES

- Complementary to MMBT3906

MAXIMUM RATINGS (T_a=25°C unless otherwise noted)

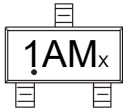

1AM= Device code
 Solid dot = Green molding compound device,
 if none, the normal device.
 X= Code

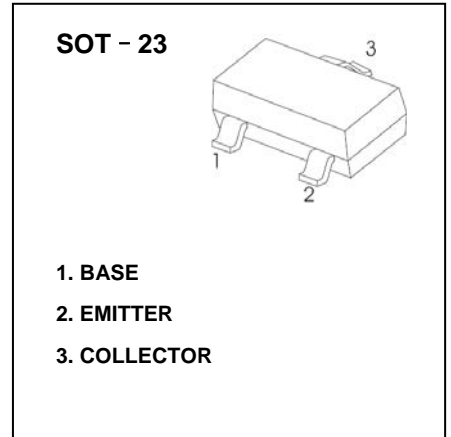

Symbol	Parameter	Value	Unit
V _{CBO}	Collector-Base Voltage	60	V
V _{CEO}	Collector-Emitter Voltage	40	V
V _{EBO}	Emitter-Base Voltage	6	V
I _C	Collector Current	200	mA
P _C	Collector Power Dissipation	200	mW
R _{θJA}	Thermal Resistance From Junction To Ambient	625	°C/W
T _J , T _{stg}	Operation Junction and Storage Temperature Range	-55~+150	°C

ELECTRICAL CHARACTERISTICS (T_a=25°C unless otherwise specified)

Parameter	Symbol	Test conditions	Min	Typ	Max	Unit
Collector-base breakdown voltage	V _{(BR)CBO}	I _C =10μA, I _E =0	60			V
Collector-emitter breakdown voltage	V _{(BR)CEO}	I _C =1mA, I _B =0	40			V
Emitter-base breakdown voltage	V _{(BR)EBO}	I _E =10μA, I _C =0	6			V
Collector cut-off current	I _{CEX}	V _{CE} =30V, V _{EB(off)} =3V			50	nA
Collector cut-off current	I _{CBO}	V _{CB} = 60V, I _E =0			100	nA
Emitter cut-off current	I _{EBO}	V _{EB} =5V, I _C =0			100	nA
DC current gain	h _{FE(1)}	V _{CE} =1V, I _C =10mA	100		300	
	h _{FE(2)}	V _{CE} =1V, I _C =50mA	60			
	h _{FE(3)}	V _{CE} =1V, I _C =100mA	30			
Collector-emitter saturation voltage	V _{CE(sat)}	I _C =50mA, I _B =5mA			0.3	V
Base-emitter saturation voltage	V _{BE(sat)}	I _C =50mA, I _B =5mA			0.95	V
Transition frequency	f _T	V _{CE} =20V, I _C =10mA, f=100MHz	300			MHz
Delay time	t _d	V _{CC} =3V, V _{BE(off)} =-0.5V I _C =10mA, I _{B1} =1mA			35	ns
Rise time	t _r	V _{CC} =3V, V _{BE(off)} =-0.5V I _C =10mA, I _{B1} =1mA			35	ns
Storage time	t _s	V _{CC} =3V, I _C =10mA, I _{B1} = I _{B2} =1mA			200	ns
Fall time	t _f	V _{CC} =3V, I _C =10mA, I _{B1} = I _{B2} =1mA			50	ns

CLASSIFICATION OF h_{FE(1)}

HFE	100-300	
RANK	L	H
RANGE	100 - 200	200 - 300

Typical Characteristics

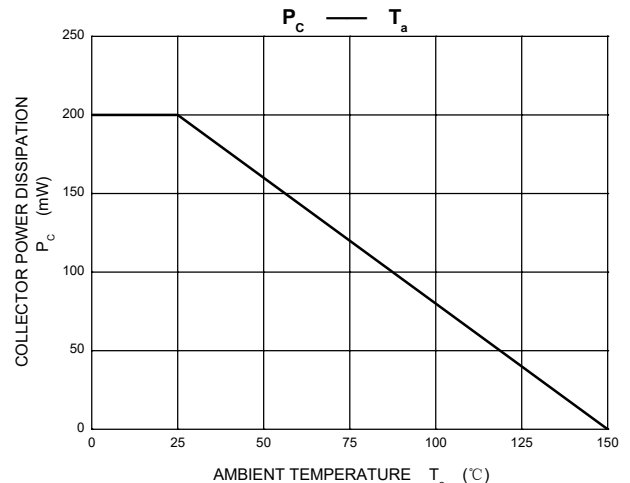
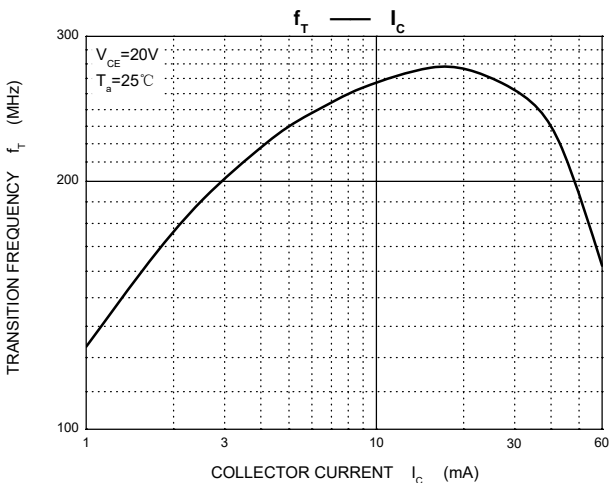
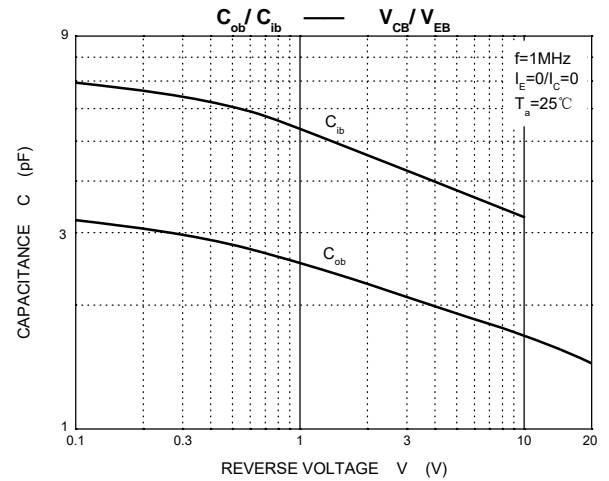
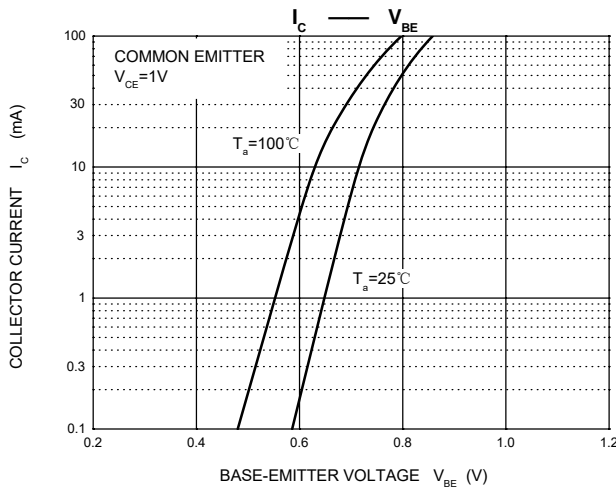
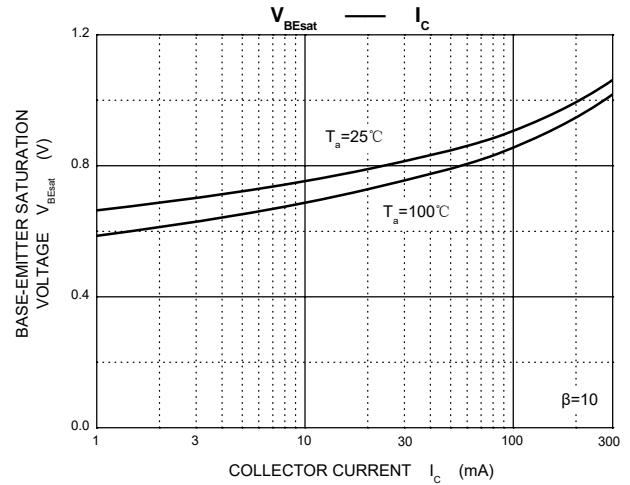
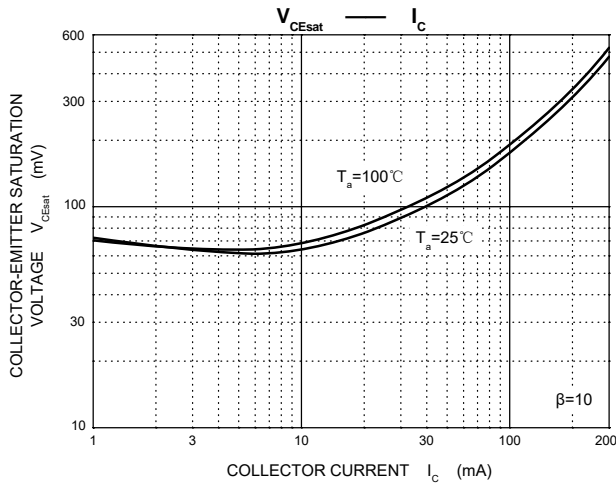
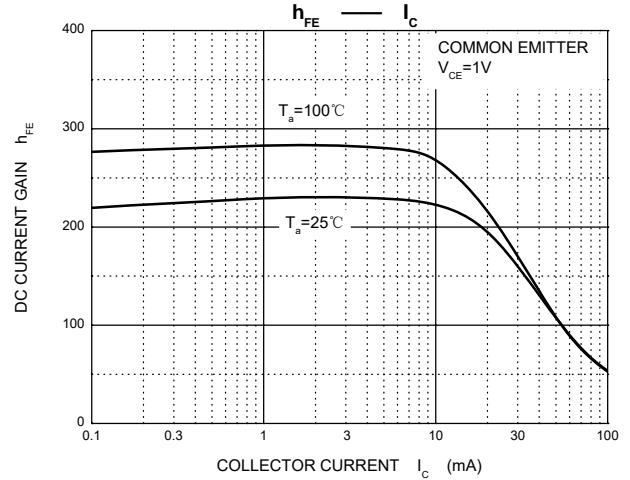
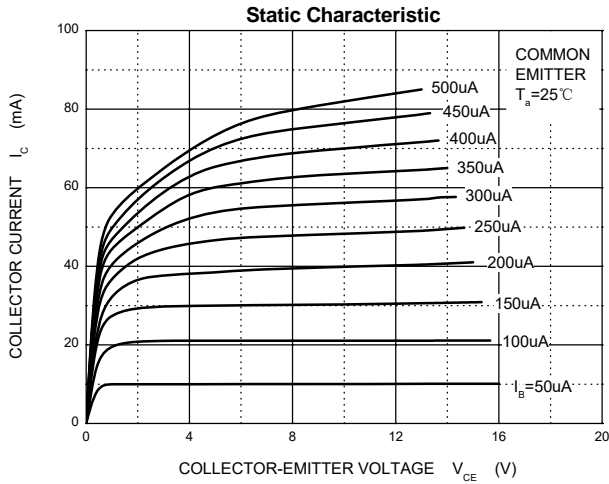

SOT-23 Package Outline Dimensions

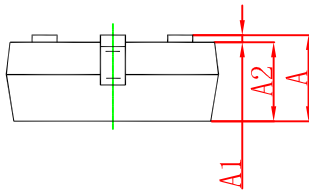
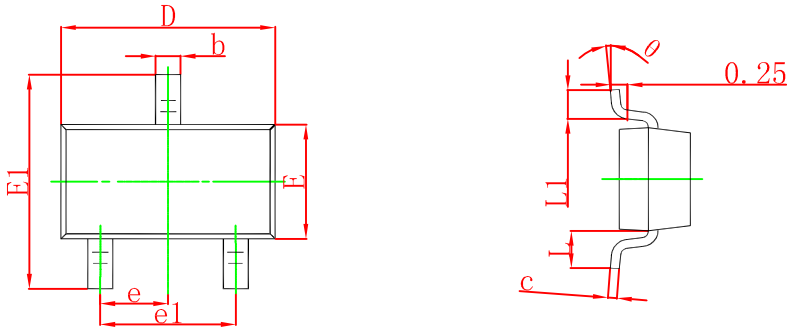

Symbol	Dimensions In Millimeters		Dimensions In Inches	
	Min	Max	Min	Max
A	0.900	1.150	0.035	0.045
A1	0.000	0.100	0.000	0.004
A2	0.900	1.050	0.035	0.041
b	0.300	0.500	0.012	0.020
c	0.080	0.150	0.003	0.006
D	2.800	3.000	0.110	0.118
E	1.200	1.400	0.047	0.055
E1	2.250	2.550	0.089	0.100
e	0.950 TYP		0.037 TYP	
e1	1.800	2.000	0.071	0.079
L	0.550 REF		0.022 REF	
L1	0.300	0.500	0.012	0.020
θ	0°	8°	0°	8°

SOT-23 Suggested Pad Layout

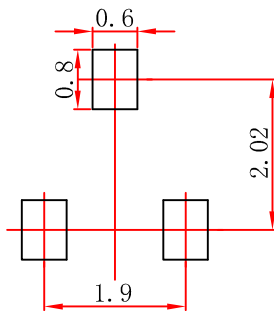

Note:

1. Controlling dimension: in millimeters.
2. General tolerance: ± 0.05 mm.
3. The pad layout is for reference purposes only.

NOTICE

JSCJ reserves the right to make modifications, enhancements, improvements, corrections or other changes without further notice to any product herein. JSCJ does not assume any liability arising out of the application or use of any product described herein.

SOT-23 Tape and Reel

SOT-23 Embossed Carrier Tape

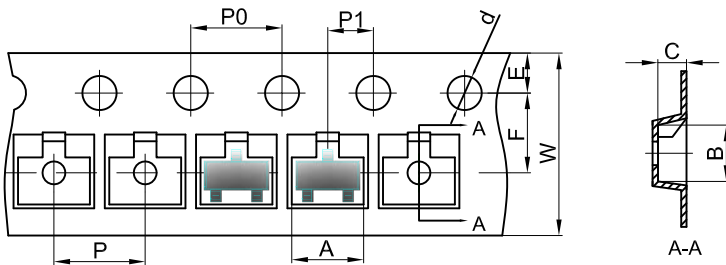

Packaging Description:
 SOT-23 parts are shipped in tape. The carrier tape is made from a dissipative (carbon filled) polycarbonate resin. The cover tape is a multilayer film (Heat Activated Adhesive in nature) primarily composed of polyester film, adhesive layer, sealant, and anti-static sprayed agent. These reeled parts in standard option are shipped with 3,000 units per 7" or 17.8cm diameter reel. The reels are clear in color and is made of polystyrene plastic (anti-static coated).

Dimensions are in millimeter										
Pkg type	A	B	C	d	E	F	P0	P	P1	W
SOT-23	3.15	2.77	1.22	Ø1.50	1.75	3.50	4.00	4.00	2.00	8.00

SOT-23 Tape Leader and Trailer

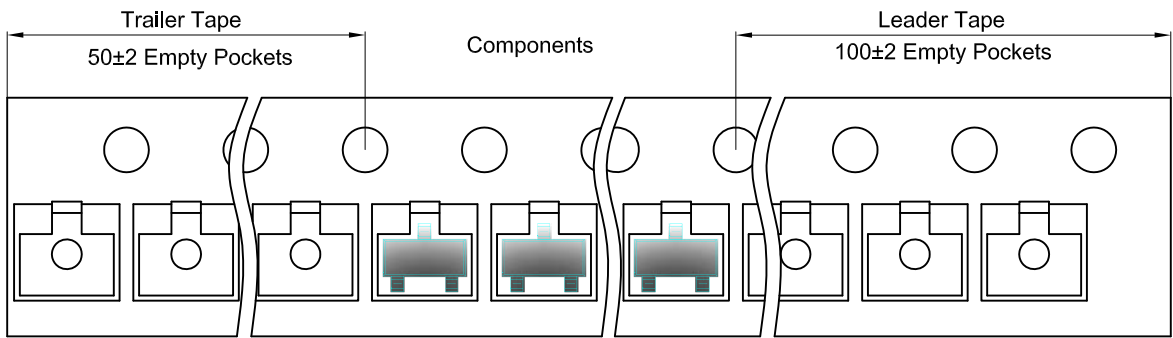

SOT-23 Reel(S)

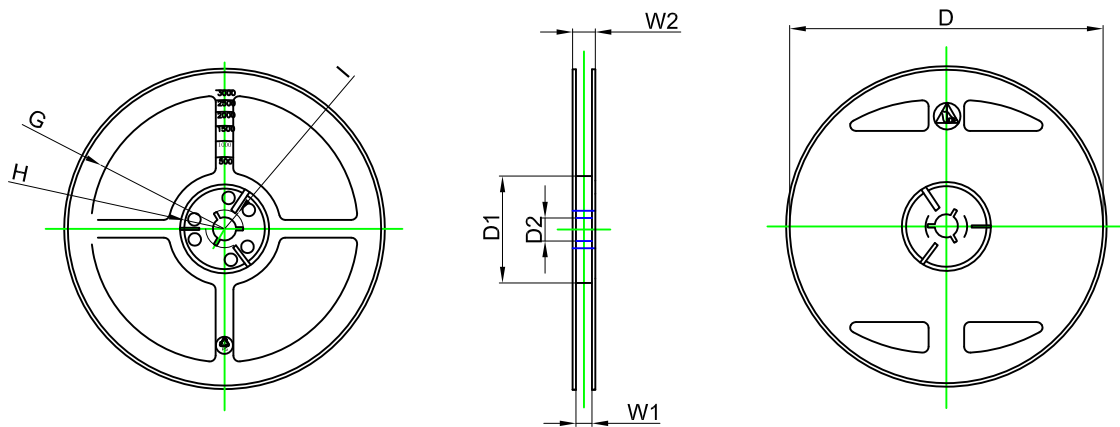

Dimensions are in millimeter								
Reel Option	D	D1	D2	G	H	I	W1	W2
7" Dia	Ø178.00	54.40	13.00	R78.00	R25.60	R9.35	9.50	12.00

REEL	Reel Size	Box	Box Size(mm)	Carton	Carton Size(mm)	G.W.(kg)
3000 pcs	7 inch	45,000 pcs	203×203×195	180,000 pcs	438×438×220	