

TL322C, TL322I DUAL LOW-POWER OPERATIONAL AMPLIFIERS

SLOS086 – D2567, OCTOBER 1979 – REVISED OCTOBER 1990

- **Wide Range of Supply Voltages**
Single Supply . . . 5 V to 30 V
Dual Supplies . . . ± 2.5 V to ± 15 V
- **Class AB Output Stage**
- **True Differential Input Stage**
- **Low Input Bias Current**
- **Internal Frequency Compensation**
- **Short-Circuit Protection**

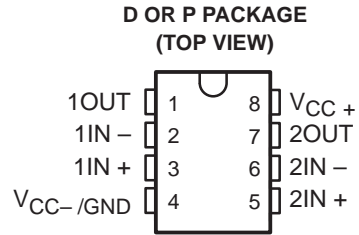

symbol (each amplifier)

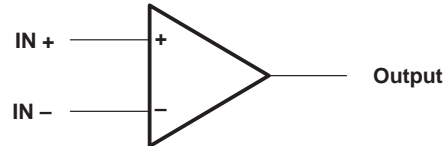

description

The TL322C and the TL322I are dual operational amplifiers similar in performance to the μ A741 but with several distinct advantages. They are designed to operate from a single supply over a range of voltages from 5 V to 30 V. Operation from split supplies is also possible provided the difference between the two supplies is 5 V to 30 V. The common-mode input range includes the negative supply. Output range is from the negative supply to $V_{CC} - 1.5$ V. Quiescent supply currents per amplifier are typically less than one-half those of the μ A741.

The TL322C is characterized for operation from 0°C to 70°C . The TL322I is characterized for operation from -40°C to 85°C .

AVAILABLE OPTIONS

TA	V _{IO} MAX AT 25°C	PACKAGE	
		SMALL OUTLINE (D)	PLASTIC DIP (P)
0°C to 70°C	10 mV	TL322CD	TL322CP
0°C to 70°C	8 mV	TL322ID	TL322IP

D packages are available taped and reeled. Add R suffix to device type, (e.g., TL322CDR).

schematic (each amplifier)

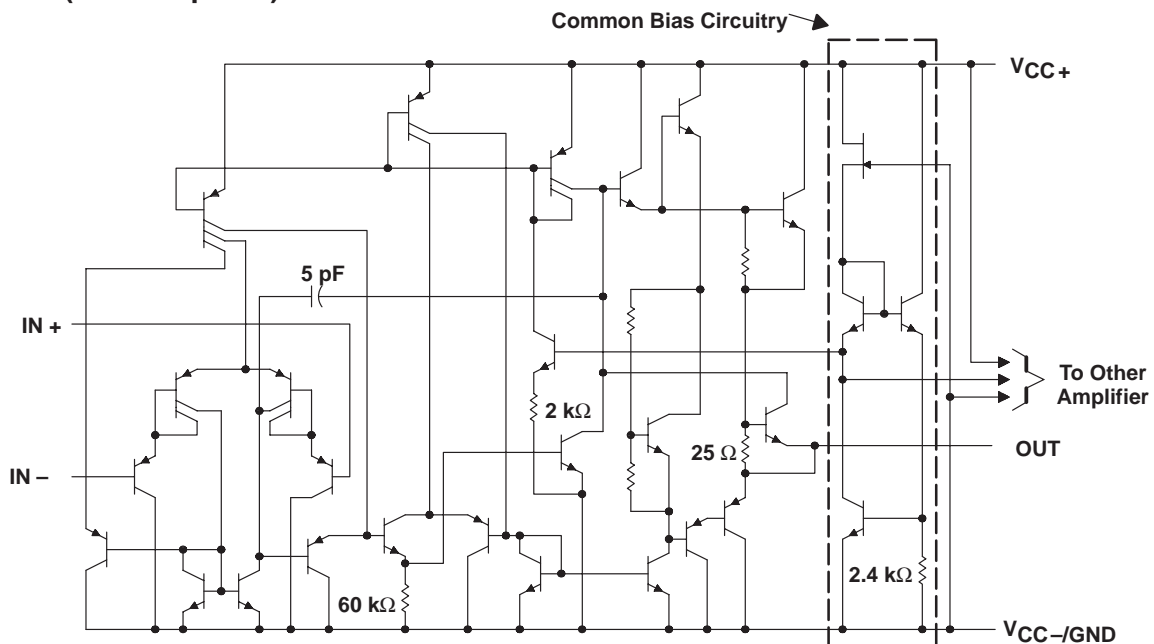

All component values shown are nominal.

PRODUCTION DATA information is current as of publication date. Products conform to specifications per the terms of Texas Instruments standard warranty. Production processing does not necessarily include testing of all parameters.

**TEXAS
INSTRUMENTS**

POST OFFICE BOX 655303 • DALLAS, TEXAS 75265

Copyright © 1990, Texas Instruments Incorporated

TL322C, TL322I

DUAL LOW-POWER OPERATIONAL AMPLIFIERS

SLOS086 – D2567, OCTOBER 1979 – REVISED OCTOBER 1990

absolute maximum ratings over operating free-air temperature range (unless otherwise noted)

	TL322C	TL322I	UNIT
Supply voltage V_{CC+} (see Note 1)	18	18	V
Supply voltage V_{CC-} (see Note 1)	-18	-18	V
Supply voltage V_{CC+} (with respect to V_{CC-})	36	36	V
Differential input voltage (see Note 2)	± 36	± 36	V
Input voltage (see Notes 1 and 3)	± 18	± 18	V
Continuous total power dissipation	See Dissipation Rating Table		
Operating free-air temperature range	0 to 70	-40 to 85	$^{\circ}\text{C}$
Storage temperature range	-65 to 150	-65 to 150	$^{\circ}\text{C}$
Lead temperature 1,6 mm (1/16 inch) from case for 10 seconds	260	260	$^{\circ}\text{C}$

- NOTES: 1. These voltage values are with respect to the midpoint between V_{CC+} and V_{CC-} .
 2. Differential voltages are at the noninverting input terminal with respect to the inverting input terminal.
 3. Neither input must ever be more positive than V_{CC+} or more negative than V_{CC-} .

DISSIPATION RATING TABLE

PACKAGE	$T_A \leq 25^{\circ}\text{C}$ POWER RATING	DERATING FACTOR	DERATE ABOVE T_A	$T_A = 70^{\circ}\text{C}$ POWER RATING	$T_A = 85^{\circ}\text{C}$ POWER RATING
D	680 mW	5.8 mW/ $^{\circ}\text{C}$	33 $^{\circ}\text{C}$	464 mW	377 mW
P	680 mW	8.0 mW/ $^{\circ}\text{C}$	65 $^{\circ}\text{C}$	640 mW	520 mW

recommended operating conditions

	MIN	NOM	MAX	UNIT
Single supply voltage, V_{CC}	5		30	V
Dual supply voltage, V_{CC+}	2.5		15	V
Dual supply voltage, V_{CC-}	-2.5		-15	V

TL322C, TL322I DUAL LOW-POWER OPERATIONAL AMPLIFIERS

SLOS086 – D2567, OCTOBER 1979 – REVISED OCTOBER 1990

electrical characteristics at specified free-air temperature, $V_{CC\pm} = 15\text{ V}$ (unless otherwise noted)

PARAMETER	TEST CONDITIONST	TL322C			TL322I			UNIT	
		MIN	TYP	MAX	MIN	TYP	MAX		
V_{IO} Input offset voltage	$V_O = 0,$ $R_S = 50\ \Omega$	25°C	2	10	2	8	mV		
		Full range		12		10			
α_{VIO} Temperature coefficient of input offset voltage	$V_O = 0,$ $R_S = 50\ \Omega$	25°C	10		10		$\mu\text{V}/^\circ\text{C}$		
I_{IO} Input offset current	$V_O = 0$	25°C	30	50	30	75	nA		
		Full range		200		250			
α_{IIO} Temperature coefficient of input offset current	$V_O = 0$	25°C	50		50		$\text{pA}/^\circ\text{C}$		
I_{IB} Input bias current	$V_O = 0$	25°C	-0.2	-0.5	-0.2	-0.5	μA		
		Full range		-0.8		-1			
V_{ICR} Common-mode input voltage range [‡]		25°C	V_{CC-} to 13	V_{CC-} to 13.5	V_{CC-} to 13	V_{CC-} to 13.5	V		
V_{OM} Peak output voltage swing	$R_L = 10\ \text{k}\Omega$	25°C	± 12	± 13.5	± 12	± 12.5	V		
		25°C	± 10	± 13	± 10	± 12			
		Full range	± 10		± 10				
A_{VD} Large-signal differential voltage amplification	$V_O = \pm 10\ \text{V},$ $R_L = 2\ \text{k}\Omega$	25°C	20	200	20	200	V/mV		
		Full range	15		15				
B_{OM} Maximum-output-swing bandwidth	$V_O(\text{PP}) = 20\ \text{V},$ $A_{VD} = 1,$ $\text{THD} \leq 5\%,$ $R_L = 2\ \text{k}\Omega$	25°C	9		9		kHz		
B_1 Unity-gain bandwidth	$V_O = 50\ \text{mV},$ $R_L = 10\ \text{k}\Omega$	25°C	1		1		MHz		
ϕ_m Phase margin	$R_L = 2\ \text{k}\Omega,$ $C_L = 200\ \text{pF}$	25°C	60°		60°				
r_i Input resistance	$f = 20\ \text{Hz}$	25°C	0.3	1	0.3	1	$\text{M}\Omega$		
r_o Output resistance	$f = 20\ \text{Hz}$	25°C	75		75		Ω		
CMRR Common-mode rejection ratio	$V_{IC} = V_{ICR}\ \text{min},$ $R_S = 50\ \Omega$	25°C	70	90	70	90	dB		
k_{SVS} Supply voltage sensitivity ($\Delta V_{IO}/\Delta V_{CC}$)	$V_{CC} = \pm 2.5\ \text{V to}$ $\pm 15\ \text{V},$ $R_S = 50\ \Omega$	25°C	30	150	30	150	$\mu\text{V}/\text{V}$		
I_{OS} Short-circuit output current [§]	$V_O = 0$	25°C	± 10	± 30	± 45	± 10	± 30	± 45	mA
I_{CC} Total supply current	$V_O = 0,$ No load	25°C	1.4	4	1.4	4	mA		

† All characteristics are under open-loop conditions unless otherwise noted. Full range for T_A is 0°C to 70°C for TL322C and -40°C to 85°C for TL322I.

‡ The V_{ICR} limits are directly linked volt-for-volt to supply voltage; the positive limit is 2 V less than V_{CC+} .

§ Temperature and/or supply voltages must be limited to ensure that the dissipation rating is not exceeded.

TL322C, TL322I DUAL LOW-POWER OPERATIONAL AMPLIFIERS

SLOS086 – D2567, OCTOBER 1979 – REVISED OCTOBER 1990

electrical characteristics, $V_{CC+} = 5\text{ V}$, $V_{CC-} = 0\text{ V}$, $T_A = 25^\circ\text{C}$ (unless otherwise noted)

PARAMETER	TEST CONDITION [†]	TL322C			TL322I			UNIT
		MIN	TYP	MAX	MIN	TYP	MAX	
V_{IO}	Input offset voltage	$V_O = 2.5\text{ V}$, $R_S = 50\ \Omega$			8			mV
I_{IO}	Input offset current	$V_O = 2.5\text{ V}$			75			nA
I_{IB}	Input bias current				-0.5			pA
V_{OM}	Peak output voltage swing [‡]	$R_L = 10\text{ k}\Omega$			3.3 3.5			V
		$R_L = 10\text{ k}\Omega$, $V_{CC+} = 5\text{ V to } 30\text{ V}$			$V_{CC+} - 1.7$			
A_{VD}	Large-signal differential voltage amplification	$V_O = 1.7\text{ V to } 3.3\text{ V}$, $R_L = 2\text{ k}\Omega$			20 200			V/mV
k_{SVS}	Supply voltage sensitivity ($\Delta V_{IO} / \Delta V_{CC+}$)	$V_{CC} = \pm 2.5\text{ V to } \pm 15\text{ V}$			150			$\mu\text{V/V}$
I_{CC}	Supply current	$V_O = 2.5\text{ V}$, No load			1.2 4			mA
V_{O1} / V_{O2}	Crosstalk attenuation	$A_{VD} = 100$, $f = 1\text{ kHz to } 20\text{ kHz}$			120			dB

[†] All characteristics are specified under open-loop conditions.

[‡] Output will swing essentially to ground.

switching characteristics, $V_{CC+} = 15\text{ V}$, $V_{CC-} = -15\text{ V}$, $A_{VD} = 1$, $T_A = 25^\circ\text{C}$ (unless otherwise noted)

PARAMETER	TEST CONDITIONS	MIN	TYP	MAX	UNIT	
SR	Slew rate at unity gain	$V_I = \pm 10\text{ V}$, $C_L = 100\text{ pF}$, See Figure 1			0.6	V/ μs
t_r	Rise time	$\Delta V_O = 50\text{ mV}$, $C_L = 100\text{ pF}$, $R_L = 10\text{ k}\Omega$, See Figure 1			0.35	μs
t_f	Fall time				0.35	μs
	Overshoot factor				20%	
	Crossover distortion	$V_{I(PP)} = 30\text{ mV}$, $V_{O(PP)} = 2\text{ V}$, $f = 10\text{ kHz}$			1%	

PARAMETER MEASUREMENT INFORMATION

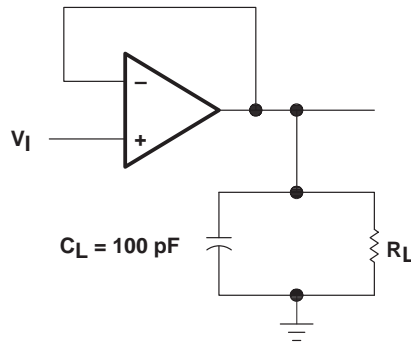

Figure 1. Unity-Gain Amplifier

TYPICAL CHARACTERISTICS†

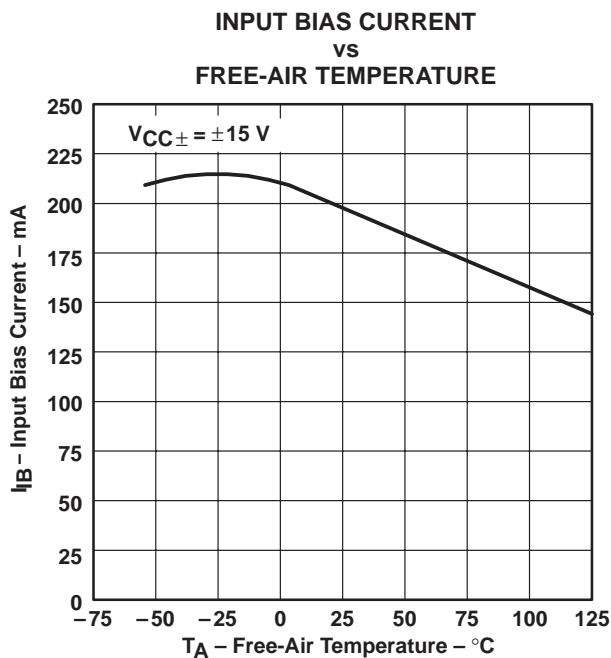

Figure 2

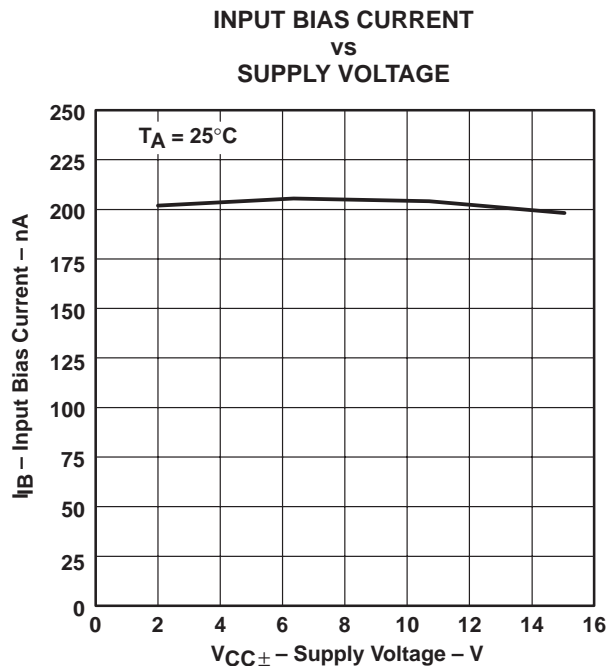

Figure 3

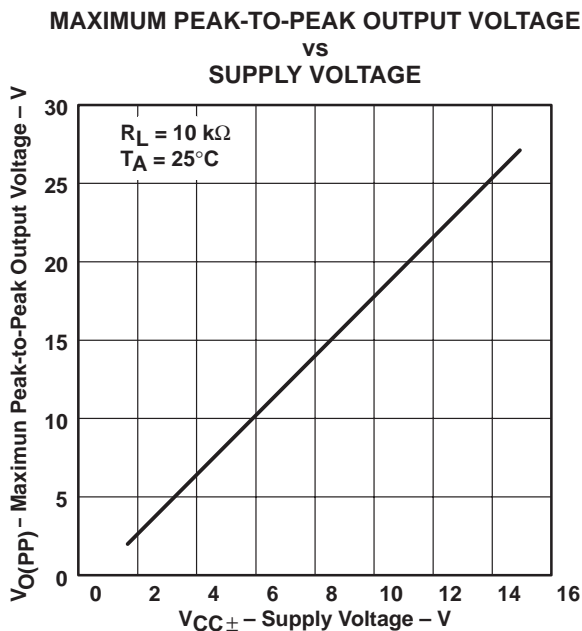

Figure 4

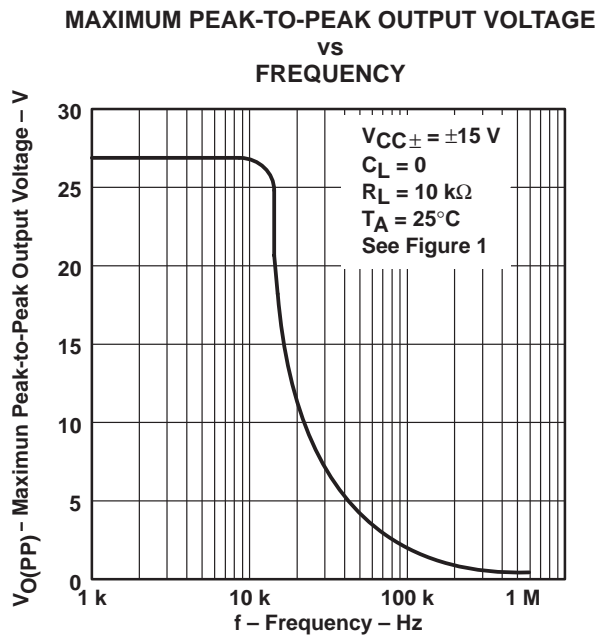

Figure 5

† Data at high and low temperatures are applicable only within the rated operating free-air temperature ranges of the various devices.

TL322C, TL322I DUAL LOW-POWER OPERATIONAL AMPLIFIERS

SLOS086 – D2567, OCTOBER 1979 – REVISED OCTOBER 1990

TYPICAL CHARACTERISTICS

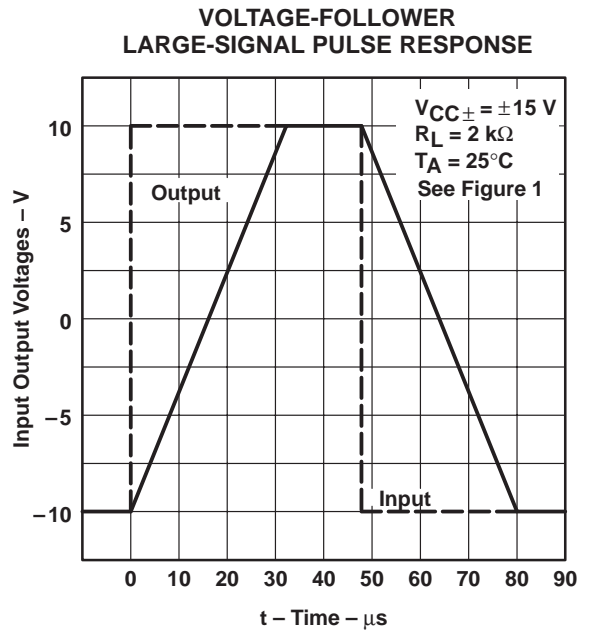
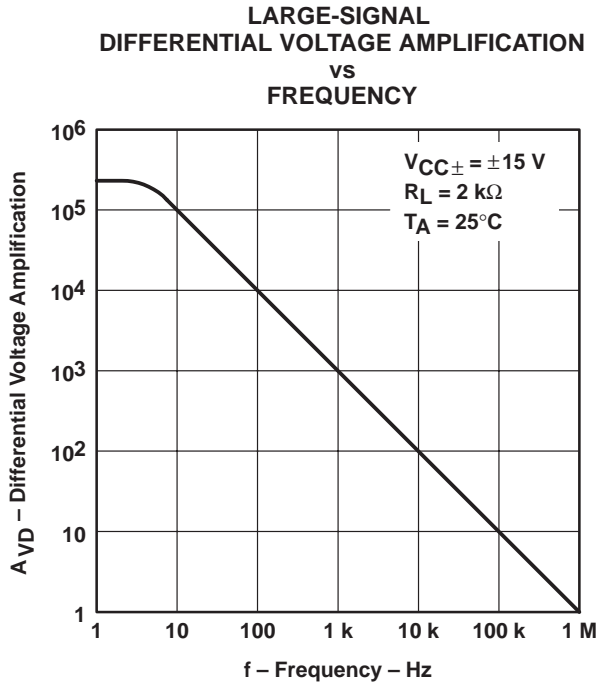

IMPORTANT NOTICE

Texas Instruments and its subsidiaries (TI) reserve the right to make changes to their products or to discontinue any product or service without notice, and advise customers to obtain the latest version of relevant information to verify, before placing orders, that information being relied on is current and complete. All products are sold subject to the terms and conditions of sale supplied at the time of order acknowledgement, including those pertaining to warranty, patent infringement, and limitation of liability.

TI warrants performance of its semiconductor products to the specifications applicable at the time of sale in accordance with TI's standard warranty. Testing and other quality control techniques are utilized to the extent TI deems necessary to support this warranty. Specific testing of all parameters of each device is not necessarily performed, except those mandated by government requirements.

CERTAIN APPLICATIONS USING SEMICONDUCTOR PRODUCTS MAY INVOLVE POTENTIAL RISKS OF DEATH, PERSONAL INJURY, OR SEVERE PROPERTY OR ENVIRONMENTAL DAMAGE ("CRITICAL APPLICATIONS"). TI SEMICONDUCTOR PRODUCTS ARE NOT DESIGNED, AUTHORIZED, OR WARRANTED TO BE SUITABLE FOR USE IN LIFE-SUPPORT DEVICES OR SYSTEMS OR OTHER CRITICAL APPLICATIONS. INCLUSION OF TI PRODUCTS IN SUCH APPLICATIONS IS UNDERSTOOD TO BE FULLY AT THE CUSTOMER'S RISK.

In order to minimize risks associated with the customer's applications, adequate design and operating safeguards must be provided by the customer to minimize inherent or procedural hazards.

TI assumes no liability for applications assistance or customer product design. TI does not warrant or represent that any license, either express or implied, is granted under any patent right, copyright, mask work right, or other intellectual property right of TI covering or relating to any combination, machine, or process in which such semiconductor products or services might be or are used. TI's publication of information regarding any third party's products or services does not constitute TI's approval, warranty or endorsement thereof.