

507



»» Features

- High rating miniature PCB Relay.
- AC & DC coil are both available.
- UL/CUL and VDE approved.
- 17A 277VAC SPDT.
- Low profile 15.7mm and high insulation system class F.
- High CTI 250 material & New Glow Wire Approved.
(E version)
- Special version for inrush rating application is available.
(507 IR type)
- Comply with RoHS-Directive 2011/65/EU.

»» Type List

◆ Standard type

Terminal style	Contact form	Insulation system	Designation (provided with)		
			Flux tight	Sealed type	Sealed type washable
PCB terminal	1A (SPNO)	F	507-1AH-F-C	507-1AH-F-V	507-1AH-F-S
	1C (SPDT)	F	507-1CH-F-C	507-1CH-F-V	507-1CH-F-S

◆ High sensitivity type (N) / Ultra-sensitivity type (N1)

PCB terminal	1A (SPNO)	F	507N-1AH-F-C	507N-1AH-F-V	507N-1AH-F-S
			507N1-1AH-F-C	507N1-1AH-F-V	507N1-1AH-F-S
	1C (SPDT)	F	507N-1CH-F-C	507N-1CH-F-V	507N-1CH-F-S
			507N1-1CH-F-C	507N1-1CH-F-V	507N1-1CH-F-S

◆ High power type

PCB terminal	1A (SPNO)	F	507H-1AH-F-C	507H-1AH-F-V	507H-1AH-F-S
	1C (SPDT)	F	507H-1CH-F-C	507H-1CH-F-V	507H-1CH-F-S

◆ High power type 、 High sensitivity type (N)

PCB terminal	1A (SPNO)	F	507HN-1AH-F-C	507HN-1AH-F-V	507HN-1AH-F-S
	1C (SPDT)	F	507HN-1CH-F-C	507HN-1CH-F-V	507HN-1CH-F-S

Note : 507A—Special footprint 5.0mm pinning version can be selected.

»» Ordering Information

507 - 1A H - - C
 1 2 3 4 5 6 7 8 9

- | | |
|--|---------------------------------------|
| 1. 507 -- Basic series designation | N -- High sensitivity type (0.40 W) |
| | N1 -- Ultra-sensitivity type (0.25 W) |
| 2. Blank -- Standard type
(1P - Terminal pitch 3.5mm) | 4. 1A -- Single pole normally open |
| A -- Standard type and special terminal pitch
(1P - Terminal pitch 5.0mm) | 1C -- Single pole double throw |
| H -- High power type (only for 1P type) | 5. C -- Contact material AgNi |
| 3. Blank -- Standard type
(DC: 0.53 W) (AC: 0.75 VA) | CA -- Contact material AgNi+Au |
| | H -- Contact material AgSnO |
| | HA -- Contact material AgSnO+Au |



6. Blank -- Standard type

F -- Class F

7. C -- Flux tight

V -- Sealed type

S -- Sealed type washable

8. Blank -- Standard type

E -- CTI 250V

IR -- 507 Inrush type(only for H, 1A/1C type)

9. -- Coil voltage (please refer to the coil rating data for the availability)

»» Contact Rating

Type	507 · 507N	507N1	507H · 507HN
Rated load (resistive)	12A 240VAC	10A 240VAC	16A 240VAC
Max. switching current	12A	10A	17A
Max. switching voltage	277VAC	277VAC	277VAC
Max. switching capacity	2880VA	2400VA	4080VA

»» Coil Rating (DC)

◆ Standard Type

Rated voltage (V)	Rated current ±10% at 23°C (mA)	Coil resistance ±10% at 23°C (Ω)	Max. continuous voltage at 85°C	Pick up voltage(Max.) at 23°C	Drop out voltage(Min.) at 23°C	Power consumption at rated voltage
3	176	17	150 % of rated voltage	75 % of rated voltage	10 % of rated voltage	approx. 0.53W
5	106	47				
6	88	68				
9	59	153				
12	44	272				
15	35	425				
18	29	611				
24	22	1,087				
36	15	2,445				
48	11	4,347				

◆ High sensitivity type (N)

Rated voltage (V)	Rated current ±10% at 23°C (mA)	Coil resistance ±10% at 23°C (Ω)	Max. continuous voltage at 85°C	Pick up voltage(Max.) at 23°C	Drop out voltage(Min.) at 23°C	Power consumption at rated voltage
3	133	22.5	150 % of rated voltage	70 % of rated voltage	10 % of rated voltage	approx. 0.40W
5	80	62				
6	67	90				
9	44	203				
12	33	360				
18	23	771				
24	17	1,440				
36	11	3,240				
48	9	5,520				

◆ Ultra-sensitivity type (N1)

Rated voltage (V)	Rated current $\pm 10\%$ at 23°C (mA)	Coil resistance $\pm 10\%$ at 23°C (Ω)	Max. continuous voltage at 85°C	Pick up voltage(Max.) at 23°C	Drop out voltage(Min.) at 23°C	Power consumption at rated voltage
3	83	36	150 % of rated voltage	75 % of rated voltage	10 % of rated voltage	approx. 0.25W
5	50	100				
6	42	144				
9	28	324				
12	21	576				
18	14	1,296				
24	10	2,304				
36	7	5,184				

»» Coil Rating (AC) [only for 507、507H]

Rated voltage (V)	Rated current $\pm 10\%$ at 23°C (mA)	Coil resistance $\pm 10\%$ at 23°C (Ω)	Max. continuous voltage at 70°C	Pick up voltage(Max.) at 23°C	Drop out voltage(Min.) at 23°C	Power consumption at rated voltage
6	125	23.4	150 % of rated voltage	80 % of rated voltage	15 % of rated voltage	approx. 0.75VA
12	62.5	100				
24	31.2	368				
42	17.8	1,188				
48	15.6	1,540				
100/110	7.45	6,880				
110/120	6.8	8,360				
200/220	3.75	26,700				
220/240	3.4	33,000				

»» Specification

Contact material	AgNi / AgSnO alloy	
Contact resistance ⁽¹⁾	100m Ω Max. (1A(100mA for Au-plating contact)/6VDC by 4 pipes m Ω meter)	
Operate time ⁽¹⁾	20ms Max.	
Release time ⁽¹⁾	10ms Max.	
Insulation resistance ⁽¹⁾	1000M Ω Min. (DC 500V)	
Dielectric strength ⁽¹⁾	Between open contact	: AC 1000V, 50/60Hz 1 min.
	Between contact and coil	: AC 5000V, 50/60Hz 1 min.
Surge voltage withstand ⁽¹⁾	Between contact and coil : 10KV (1.2X50) μ S	
Vibration resistance	Operating extremes	10~55Hz , amplitude 1.5 mm
	Damage limits	10~55Hz , amplitude 1.5 mm
Shock resistance	Operating extremes	10G
	Damage limits	100G
Life expectancy	Mechanical	30,000,000 operations 10,000,000 operations (for AC type) (frequency 36,000 operations /hr)
	Electrical	100,000 operations (frequency 360 operations /hr)

Operating ambient temperature	DC coil	-40~+85°C (no freezing) ⁽²⁾
	AC coil	-40~+70°C (no freezing)
Weight	Approx. 10 g	

Note : (1) initial value

(2) special version of high temperature 105°C can be selected.

»» Safety Approval

Certified	UL / CUL	VDE
File No.	E88991	40006746

»» Safety Approval Rating (VDE)

◆ DC coil

◆ AC coil

507H、507HN	507、507N、507N1	507H	507
17A 250VAC T105	12A 250VAC T105	17A 250VAC T85	12A 250VAC T85

»» Safety Approval Rating (UL/CUL)

507		507N1
AgNi contact	AgSnO contact	
NO/NC: 17A 277VAC NO: 10FLA 250VAC 12A 30VDC 1HP 480VAC NC: 1/2HP 120/240/480VAC	NO/NC: 17A 277VAC 10FLA 250VAC NO: 1HP 120/240/480VAC TV-8 NC: 12A 30VDC 1/2HP 120/240/480VAC	17A 277VAC 12A 30VDC

»» Outline Dimensions

◆ 507 1P

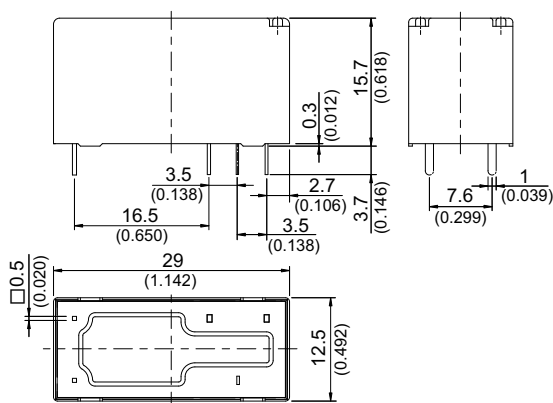

◆ 507H 1P

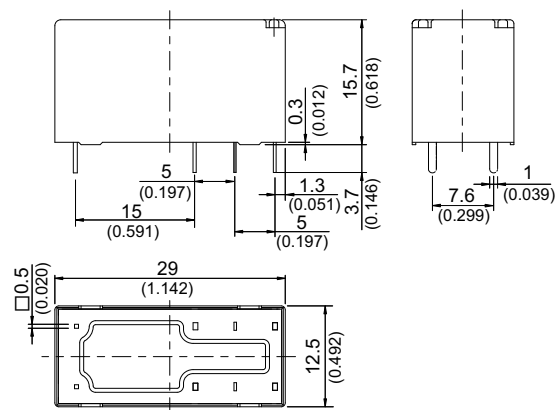

◆ 507A 1P

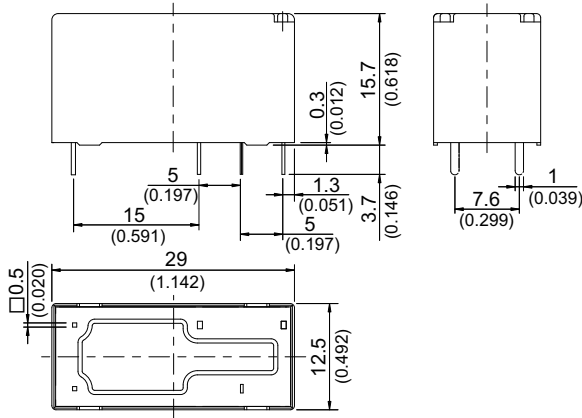

»» Wiring Diagram

BOTTOM VIEW

◆ 507 1P

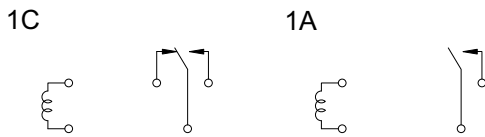

◆ 507H 1P

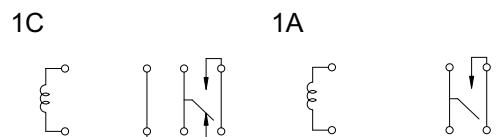

◆ 507A 1P

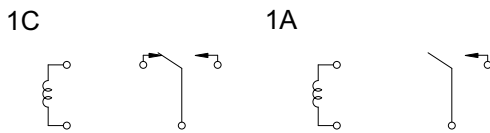

»» PC Board Layout

BOTTOM VIEW

◆ 507 1P

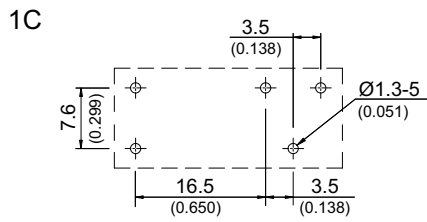

1A

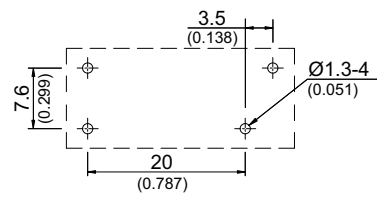

◆ 507H 1P

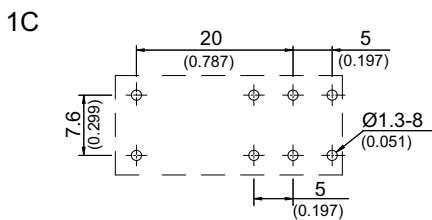

1A

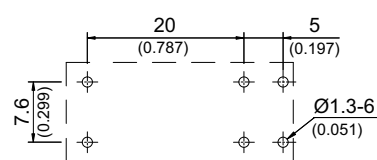

◆ 507A 1P

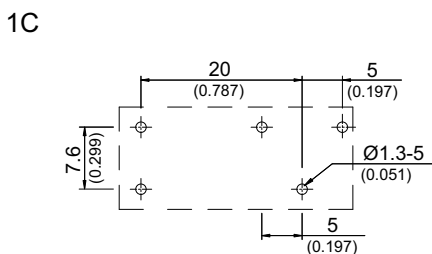

1A

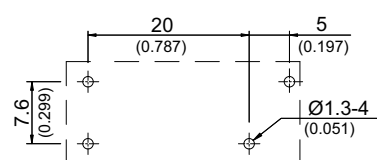

»» Engineering Data

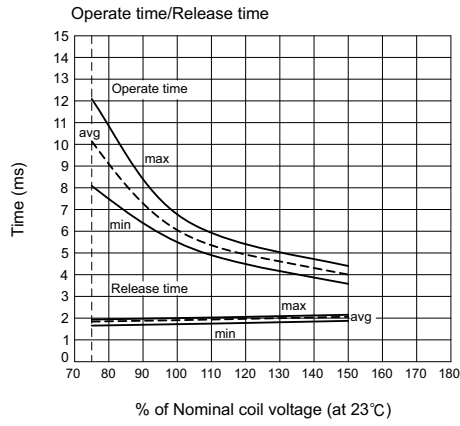
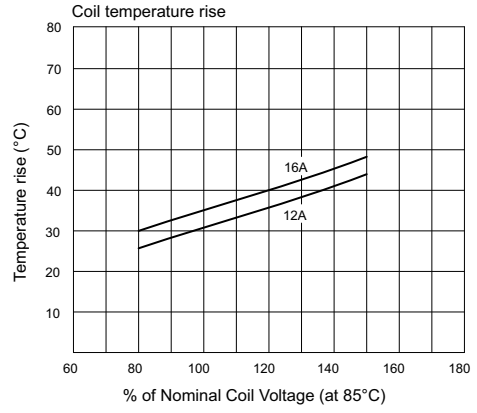
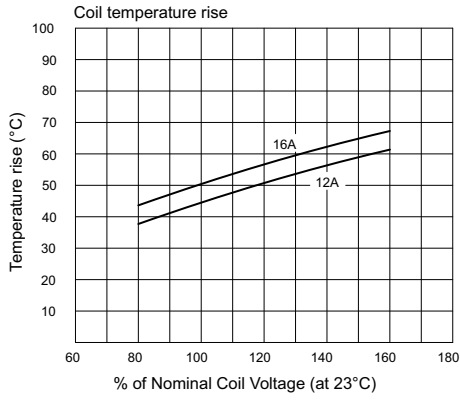

Mouser Electronics

Authorized Distributor

Click to View Pricing, Inventory, Delivery & Lifecycle Information:

Song Chuan:

[507-2AC-F-S 12VDC](#) [507-2AC-F-S 24VDC](#) [507-2AC-F-S 48VDC](#) [507-2AC-F-S 5VDC](#) [507-2CC-F-C 5VDC](#) [507-2CC-F-S 24VDC](#) [507-2CC-F-S 48VDC](#) [507-2CC-F-S 5VDC](#) [507-2CC-F-S 9VDC](#) [507-1CC-F-S-12VDC](#) [507-1CC-F-S-24VDC](#) [507-2CC-F-C-24VDC](#) [507H-1AH-F-S-IR-12VDC](#) [507H1AHFSIR24VDC](#) [507H-1CC-F-S-12VDC](#) [507H-1CH-F-S-12VDC](#) [507H-1CH-F-S-24VDC](#) [507WP1-1AC-F-S-12VDC](#) [507WP1-1AC-F-S-24VDC](#) [507WP2-1AC-F-S](#) [507-2AC-F-C 12VDC](#) [507-2CC-F-C 48VDC](#) [507H-1AH-F-C-12VDC](#) [507-2AC-F-C 24VDC](#) [507-2CC-F-C 9VDC](#) [507-2CC-C-12VDC](#) [507-2CC-F-C 12VDC](#) [507N-2CCA-C-E-24VDC](#) [507HN-1AC-C-E-24VDC](#) [507HN-1CH-F-C-12VDC](#) [507H-1CH-F-C-IR-24VDC](#) [507-2CH-S-24VDC](#) [507HN-1CH-F-S-24VDC](#) [507H-1CH-F-S-110VDC](#) [507-1CC-F-C-220240VAC](#) [507HN-1CH-F-S-12VDC](#) [507-2CH-F-C-12VDC](#) [507HN-1CC-F-C-12VDC](#) [507H-1CH-F-C-24VDC](#) [507N-2CC-F-C-48VDC](#) [507N-2CC-F-S-12VDC](#) [507N-2CC-F-C-12VDC](#) [507H-1CH-F-C-12VDC](#) [507HN-1CH-F-S-48VDC](#) [507N-2CC-F-C-110VDC](#) [507-1CH-F-C-12VDC](#) [507N-2CC-F-S-24VDC](#) [507HN-1AC-F-S-24VDC](#) [507-1AC-F-S-12VDC](#) [507N-1CC-F-S-12VDC](#) [507N-2CC-F-C-24VDC](#) [507H-1CH-F-S IR 12VDC](#) [507N-1CH-F-S-12VDC](#) [507HN-1CC-F-S-12VDC](#) [507H-1AC-F-S-12VDC](#) [507H-1CH-F-S-220240VAC](#) [507H-1AH-F-S-12VDC](#) [507-1AH-F-C-12VDC](#) [507H-1AH-F-S-24VDC](#)