

High Efficient Surface Mount Rectifiers

FEATURES

- Low power loss, high efficiency
- Ideal for automated placement
- Glass passivated junction chip.
- Fast switching for high efficiency
- Moisture sensitivity level: level 1, per J-STD-020
- Compliant to RoHS Directive 2011/65/EU and in accordance to WEEE 2002/96/EC
- Halogen-free according to IEC 61249-2-21 definition



MECHANICAL DATA

Case: DO-214AA (SMB)

Molding compound, UL flammability classification rating 94V-0

Base P/N with suffix "G" on packing code - green compound (halogen-free)

Base P/N with prefix "H" on packing code - AEC-Q101 qualified

Terminal: Matte tin plated leads, solderable per JESD22-B102

Meet JESD 201 class 1A whisker test

with prefix "H" on packing code meet JESD 201 class 2 whisker test

Polarity: Indicated by cathode band

Weight: 0.093 g (approximately)

DO-214AA (SMB)

MAXIMUM RATINGS AND ELECTRICAL CHARACTERISTICS (T _A =25°C unless otherwise noted)										
PARAMETER	SYMBOL	HS 2A	HS 2B	HS 2D	HS 2F	HS 2G	HS 2J	HS 2K	HS 2M	UNIT
Maximum repetitive peak reverse voltage	V _{RRM}	50	100	200	300	400	600	800	1000	V
Maximum RMS voltage	V _{RMS}	35	70	140	210	280	420	560	700	V
Maximum DC blocking voltage	V _{DC}	50	100	200	300	400	600	800	1000	V
Maximum average forward rectified current	I _{F(AV)}	2								A
Peak forward surge current, 8.3 ms single half sine-wave superimposed on rated load	I _{FSM}	50								A
Maximum instantaneous forward voltage (Note 1) I _F = 2 A	V _F	1.0			1.3		1.7			V
Maximum reverse current @ rated VR T _J = 25 °C T _J = 125 °C	I _R	5 150								μA
Maximum reverse recovery time (Note 2)	T _{rr}	50				75				ns
Typical junction capacitance (Note 3)	C _j	50				30				pF
Typical thermal resistance	R _{θJA}	80								°C/W
Operating junction temperature range	T _J	- 55 to +150								°C
Storage temperature range	T _{STG}	- 55 to +150								°C

Note 1: Pulse test with PW=300μs, 1% duty cycle

Note 2: Reverse Recovery Test Conditions: I_F=0.5A, I_R=1.0A, I_{RR}=0.25A

Note 3: Measured at 1 MHz and Applied V_R=4.0 Volts

ORDERING INFORMATION					
PART NO.	AEC-Q101 QUALIFIED	PACKING CODE	GREEN COMPOUND CODE	PACKAGE	PACKING
HS2x (Note 1)	Prefix "H"	R5	Suffix "G"	SMB	850 / 7" Plastic reel
		R4		SMB	3,000 / 13" Paper reel
		M4		SMB	3,000 / 13" Plastic reel

Note 1: "x" defines voltage from 50V (HS2A) to 1000V (HS2M)

EXAMPLE					
PREFERRED P/N	PART NO.	AEC-Q101 QUALIFIED	PACKING CODE	GREEN COMPOUND CODE	DESCRIPTION
HS2M R5	HS2M		R5		
HS2M R5G	HS2M		R5	G	Green compound
HS2MHR5	HS2M	H	R5		AEC-Q101 qualified

RATINGS AND CHARACTERISTICS CURVES

(TA=25°C unless otherwise noted)

FIG. 1- MAXIMUM FORWARD CURRENT DERATING CURVE

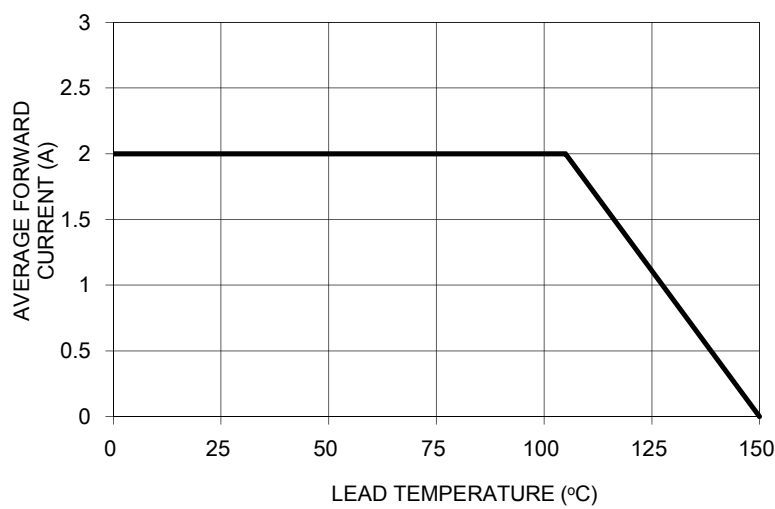

FIG. 2- TYPICAL REVERSE CHARACTERISTICS

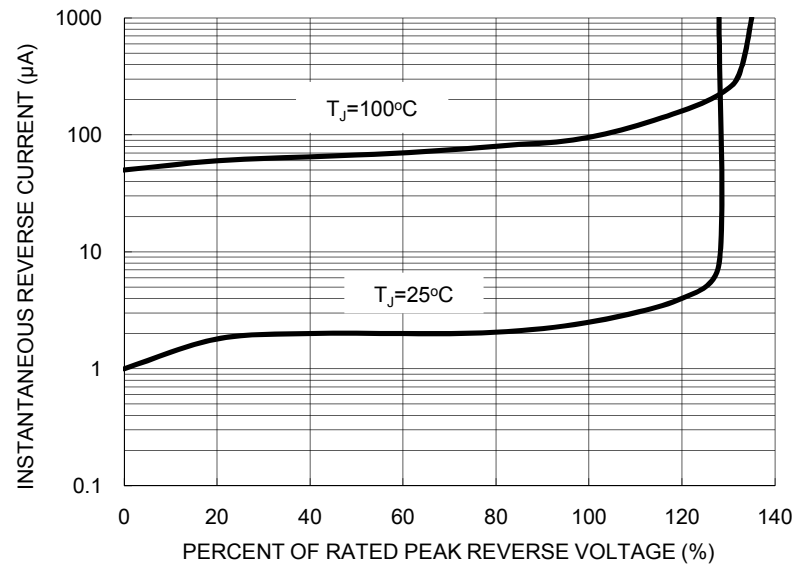

FIG. 3- MAXIMUM NON-REPETITIVE FORWARD SURGE CURRENT

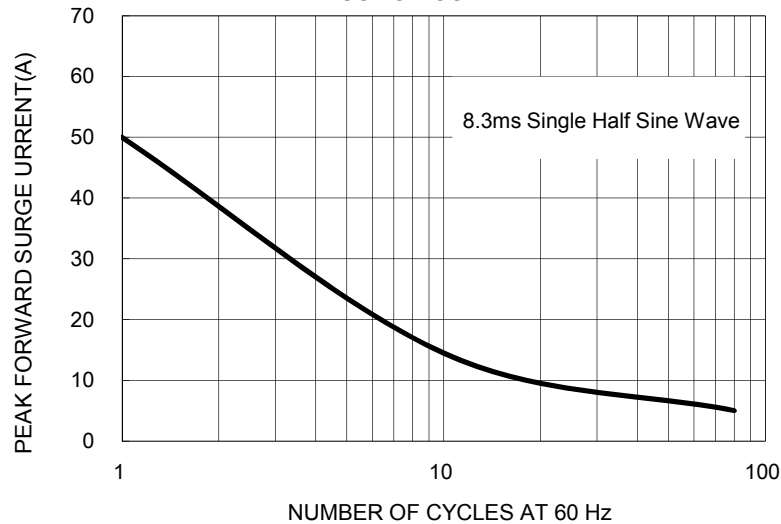

FIG. 5- TYPICAL INSTANTANEOUS FORWARD CHARACTERISTICS

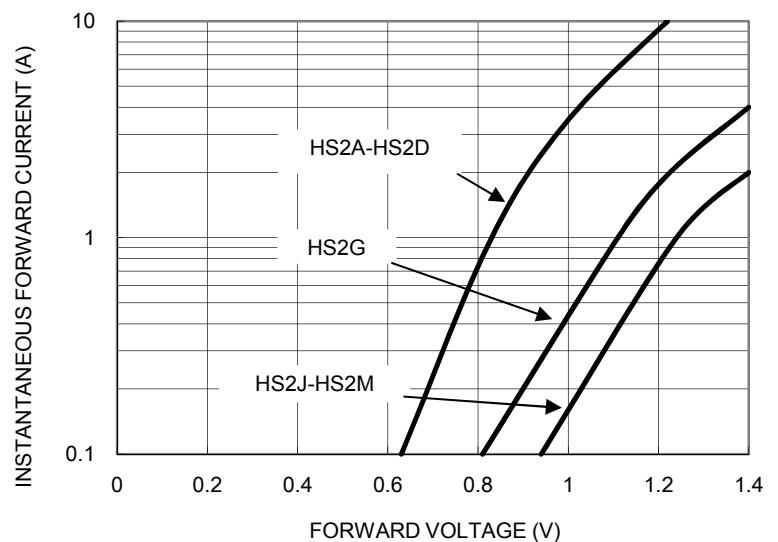

FIG. 4- TYPICAL JUNCTION CAPACITANCE

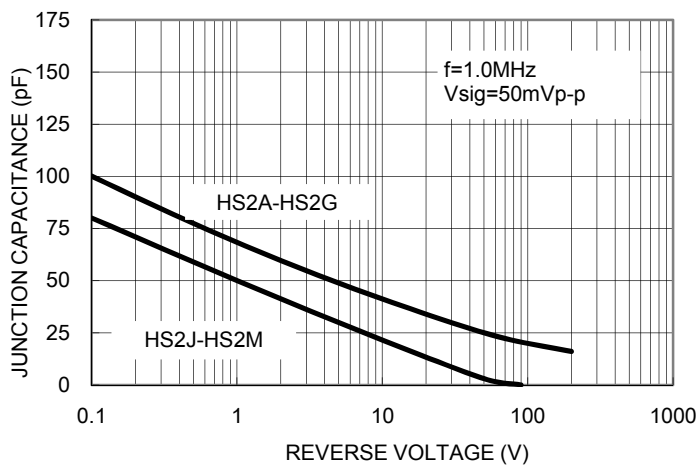
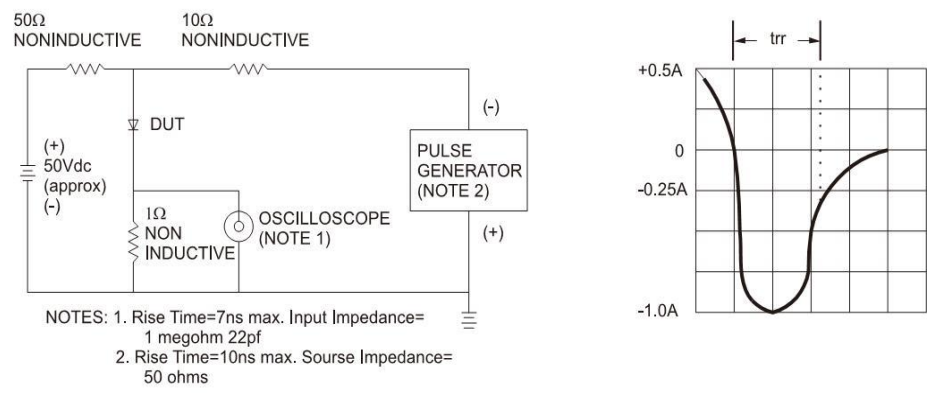
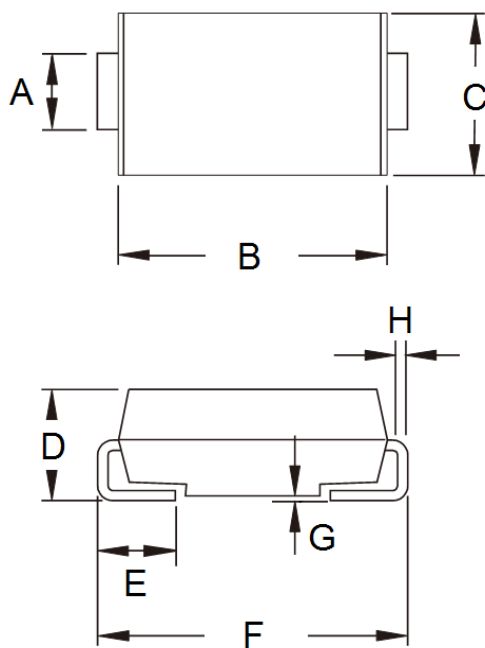

FIG.6- REVERSE RECOVERY TIME CHARACTERISTIC AND TEST CIRCUIT DIAGRAM



PACKAGE OUTLINE DIMENSIONS

DO-214AA (SMB)



DIM.	Unit (mm)		Unit (inch)	
	Min	Max	Min	Max
A	1.95	2.10	0.077	0.083
B	4.25	4.75	0.167	0.187
C	3.48	3.73	0.137	0.147
D	1.99	2.61	0.078	0.103
E	0.90	1.41	0.035	0.056
F	5.10	5.30	0.201	0.209
G	0.10	0.20	0.004	0.008
H	0.15	0.31	0.006	0.012

SUGGESTED PAD LAYOUT

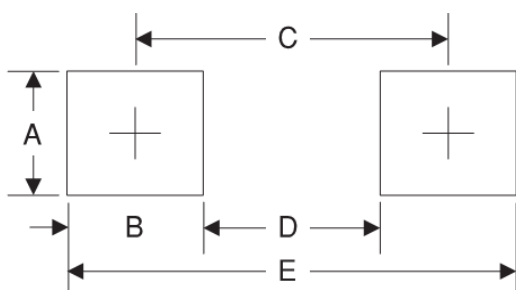

Symbol	Unit (mm)	Unit (inch)
A	2.3	0.091
B	2.5	0.098
C	4.3	0.169
D	1.8	0.071
E	6.8	0.268

MARKING DIAGRAM



- P/N = Specific Device Code
- G = Green Compound
- YW = Date Code
- F = Factory Code

Notice

Specifications of the products displayed herein are subject to change without notice. TSC or anyone on its behalf, assumes no responsibility or liability for any errors inaccuracies.

Information contained herein is intended to provide a product description only. No license, express or implied, to any intellectual property rights is granted by this document. Except as provided in TSC's terms and conditions of sale for such products, TSC assumes no liability whatsoever, and disclaims any express or implied warranty, relating to sale and/or use of TSC products including liability or warranties relating to fitness for a particular purpose, merchantability, or infringement of any patent, copyright, or other intellectual property right.

The products shown herein are not designed for use in medical, life-saving, or life-sustaining applications. Customers using or selling these products for use in such applications do so at their own risk and agree to fully indemnify TSC for any damages resulting from such improper use or sale.

Mouser Electronics

Authorized Distributor

Click to View Pricing, Inventory, Delivery & Lifecycle Information:

Taiwan Semiconductor:

[HS2A R4G](#) [HS2JHR5](#) [HS2DHR5](#) [HS2MHR5](#) [HS2KHR5](#) [HS2B R5G](#) [HS2JHR4](#) [HS2FHR5](#) [HS2F R5](#) [HS2M R5G](#)
[HS2BHR5](#) [HS2D R5G](#) [HS2AHR4](#) [HS2GHR4](#) [HS2F R5G](#) [HS2BHR4](#) [HS2A R5](#) [HS2G R5](#) [HS2G R5G](#) [HS2MHR4](#)
[HS2K R5G](#) [HS2GHR5](#) [HS2DHR4](#) [HS2J R5G](#) [HS2KHR4](#) [HS2D R5](#) [HS2FHR4](#) [HS2A R5G](#) [HS2B R5](#) [HS2AHR5](#)
[HS2K R5](#) [HS2D M4G](#) [HS2F M4G](#) [HS2G M4G](#) [HS2A M4G](#) [HS2B M4G](#) [HS2K M4G](#) [HS2M M4G](#) [HS2J M4G](#)