

# NeoDen YY1

## Automatic Pick and Place Machine

### User Manual



Model: ..... NeoDen YY1 Automatic Pick and Place Machine .....

Version: ..... V1.0 .....

## Note!

In order to make your experience with the NeoDenYY1 better, please read this manual in detail before using the machine, fully understand the function and use of each part of the machine, and operate it according to the manual's requirements.

## Cautions

1. Please work with the machine in normative environment, make sure no direct sunlight irradiation, otherwise it will reduce the machine service life and cause camera recognition failed.
2. It's better to wear anti-static clothing when operate the machine. Strong static may bring interference to the screen and the IC on the PCB.
3. Keep machine in regular maintenance and cleaning. Please also make sure no water or hand touch on the X/Y guide rails in case any rusting.
4. Please make sure the machine under power- off status while you need any machine inside operation , in case any harm to the hands.
5. Make sure no any dirty things like solder paste stick on the nozzle, otherwise it will have influence on placement effect, please keep nozzle clear.
6. With old chips or devices, the pins are easily darkened by oxidation and are not easily recognized by the camera, so please try to use new devices.
7. Helps can be found on many pages with icon '?', you can click it to get related information.
8. Should any difficult issue, please contact us freely, we'll supply assistance in time.

## Uses

1. Please do not use the machine for any other purpose. Otherwise we are not responsible for any liability arising therefrom.
2. Please do not modify the machine. We are not responsible for any accidents caused by modifications.

## Unpacking Instructions

Please follow the instructions for unpacking:

Step 1: Please remove the packing such as gin tape, pearl cotton etc.

Step 2: Raise the upper part of the machine case.

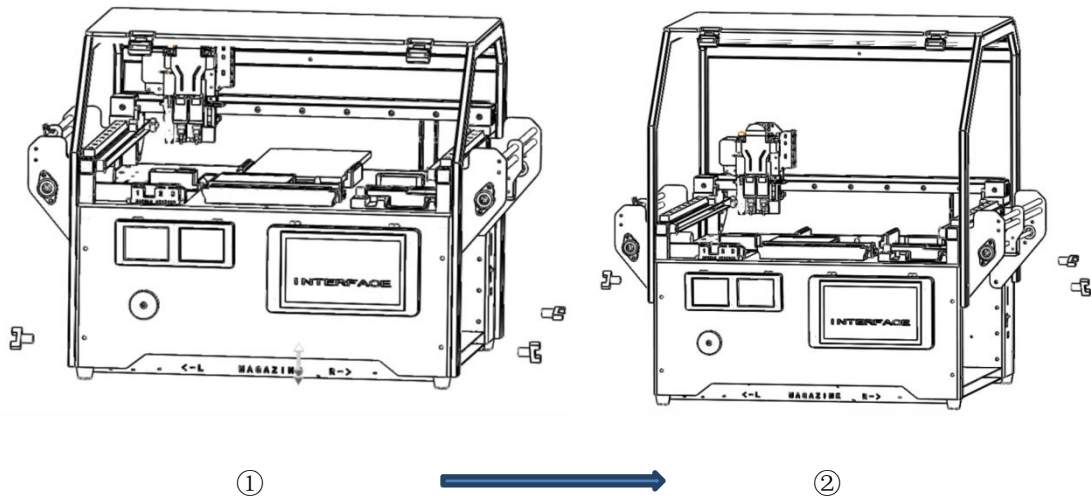

Step 3: Installation of acrylic cover.

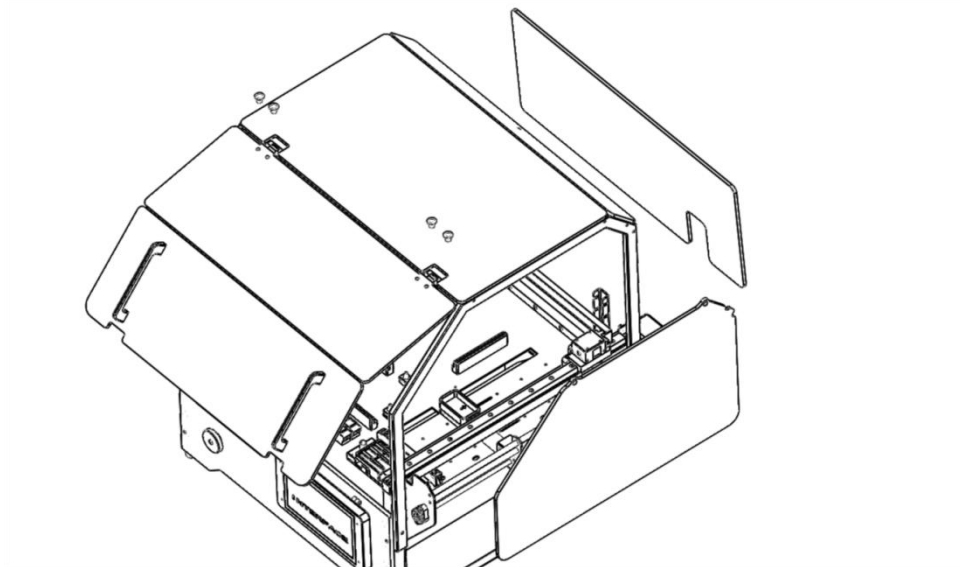

## Catalog

1. Machine Overview .....	5
1.1 Machine Dimension .....	5
1.2 Machine Structure .....	6
2. How to Quickly Place Your First Board .....	7
3. Software Interfaces Introduction .....	9
3.1 Home Page and File List.....	9
3.2 File Editing Page.....	10
3.2.1 Edit Component.....	10
3.2.2 Edit Fiducial.....	11
3.2.3 Panelized PCB.....	12
3.2.4 Mount.....	13
3.3 Manual Test.....	14
3.4 Feeder Settings.....	15
3.4.1 Tape Feeder.....	15
3.4.2 Flexible Feeder.....	16
3.4.3 Bulk Feeder.....	16
3.5 System Parameters.....	17
3.5.1 Basic Parameters.....	18
3.5.2 Head and Needle Calibration.....	19
3.5.3 Up-looking Camera Calibration.....	21
4. Machine Operation Introduction.....	24
4.1 PCB Fixing Methods.....	24
4.2 Install the Tape Reel.....	25
4.3 Stick Feeder.....	26
4.4 Short Tape Reel Feeder.....	27
4.5 Nozzle and Auto Nozzle Replacement.....	28
4.5.1 Introduction and Selection of Nozzles.....	28
4.5.2 Auto Nozzle Change.....	30
4.6 Vacuum Detection Module.....	31
4.7 Trash Box.....	33
4.8 Magnetic Acrylic Cover.....	34
5. Machine Adjustment Guide and Maintenance.....	35
5.1 How to Adjust the Peeling Force.....	35
5.2 How to Adjust the Shrapnel of Tape Feeder.....	35
5.3 How to Adjust the Belt Tightness.....	36
5.4 Daily Maintenance.....	37

# 1. Machine Overview

## 1.1 Machine Dimension

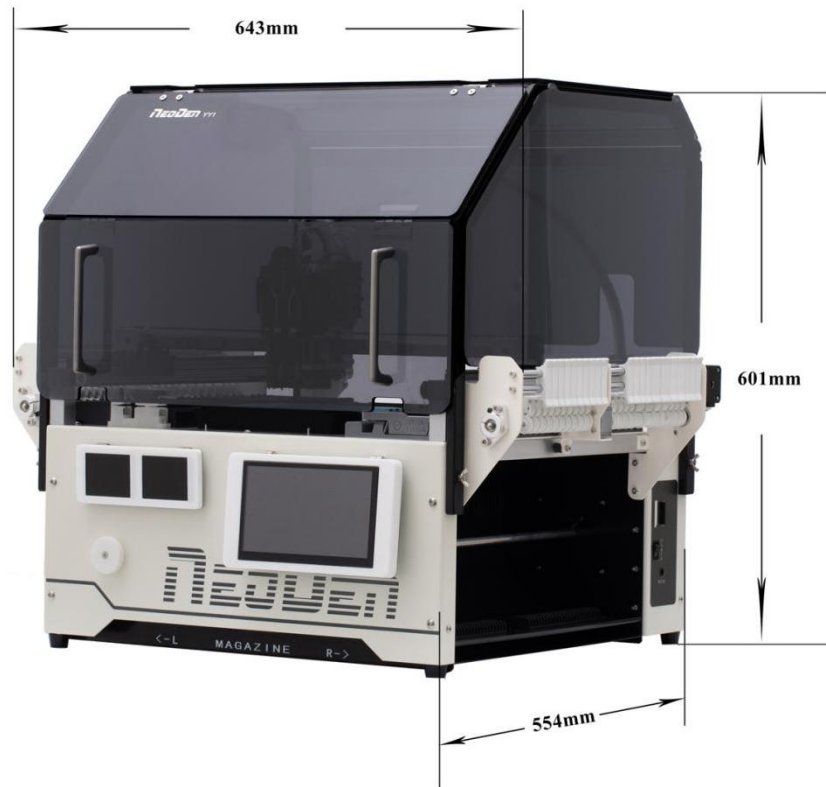
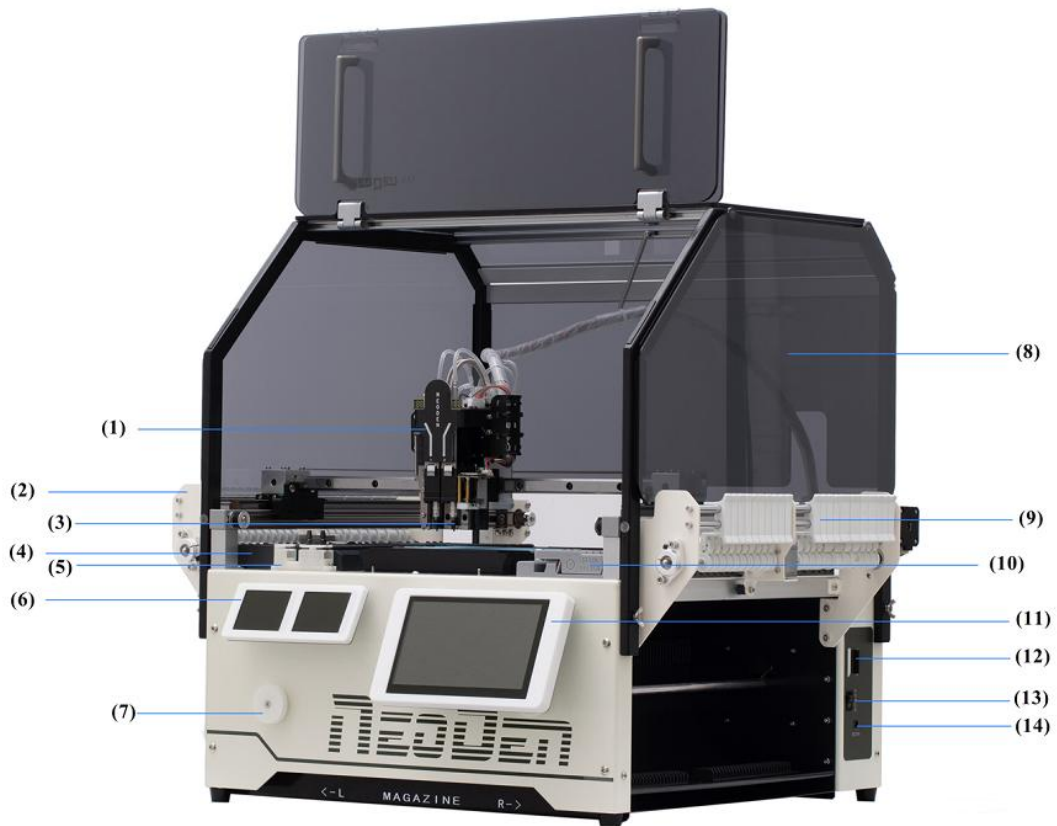

Figure 1-Machine dimension drawing

## 1.2 Machine Structure



- |                          |                         |
|--------------------------|-------------------------|
| (1) Placement head       | (8) Safety cover        |
| (2) Peeler left          | (9) Peeler right        |
| (3) Nozzle               | (10) Stick feeder       |
| (4) Tape feeder left     | (11) Touch screen       |
| (5) Nozzle station (ANC) | (12) SD card            |
| (6) Camera Display       | (13) on/off switch      |
| (7) Peeler holder        | (14) Power port (DC24V) |

Figure 2-Schematic diagram of machine structure

## 2. How to Quickly Place Your First Board

Quick operation flow chart

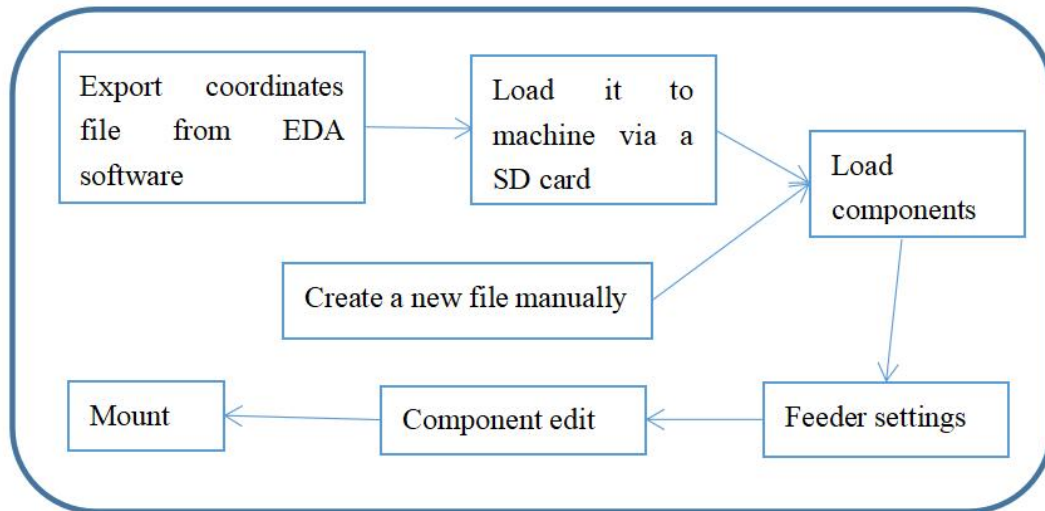

1. You have two ways to generate placement files, export csv files through EDA design software or manually create new ones.
2. Before exporting the csv file, you need to set the lower left corner as the origin point (the Bottom layer is the lower right corner), as shown in Figure A.

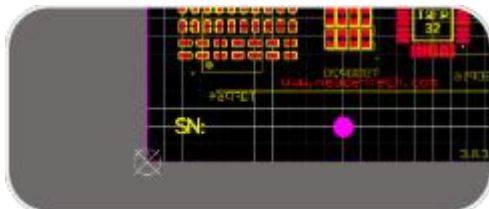

3. After the EDA software exports the form file, please open it on the computer to confirm the components information, you can delete some useless information such as plug-in components, but the format cannot be changed.
4. Copy the csv file to the SD card and insert it into the machine to do following operation. If the format is correct, the machine will read and convert the csv file information.
5. On the machine, the necessary steps are: Load components > Feeder settings > Component editing > Placement.
6. Fiducials and panelized boards are optional, can be set according to the page instructions if necessary.
7. When place the first board, use the "step" function to try to place a few components firstly, and after confirming the settings and placement files are both correct, then can be automatically placed. You can also stick double-sides adhesive tape to verify the first board (if the fiducials are set, the double-sides adhesive tape cannot cover the fiducials).

8. The "Add New" button can manually create a standard YY1 csv placement file, and then you can add and modify components on the component editing page.
9. You can also get your PCB placement file by modifying the standard YY1 csv placement file on the computer. Note: The coordinates cannot have negative numbers, and the angle range is 180 degrees to -180 degrees; other original formats cannot be changed.



### 3. Software Interfaces Introduction

#### 3.1 Home Page and File List

After initializing, it will turn to the Home Page ( Fig.YY1-01). Left side will show the files which exist in SD card and right side are three buttons for interfaces of “Manual Test”, “Feeder Settings” and “Parameters”. On the right top corner, there’s a “How to begin” guidance to help users start programming quickly.

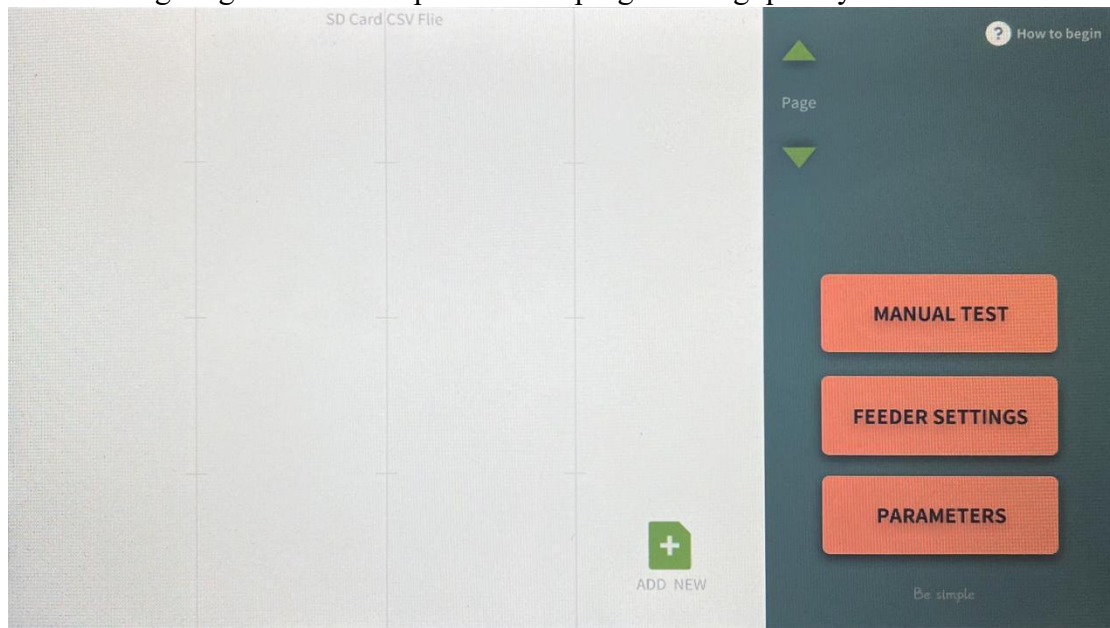

YY1-01

If without SD card inserted, the left side file list will be empty and the “Add new” button is also unworkable. After SD card well inserted, all files will be automatically show up and users can also create new file through the “Add new” button (Fig. YY1-02)

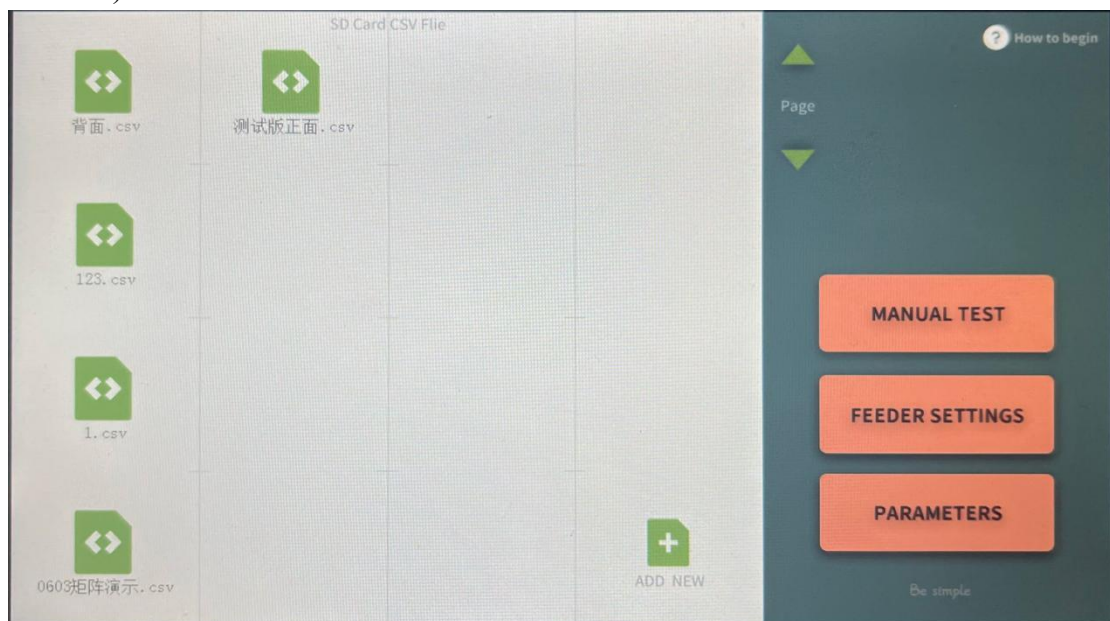

YY1-02

## 3.2 File Edit Page

As previously referred, the CSV coordinate file can be directly imported into machine through SD card for programming. What we must take notice is the correct CSV file will be automatically converted to the related format while loaded but if there's error warning, it should be the file format wrong or the file was generated by some unsupported EDA. Click correct file, you can continue programming or placement process.

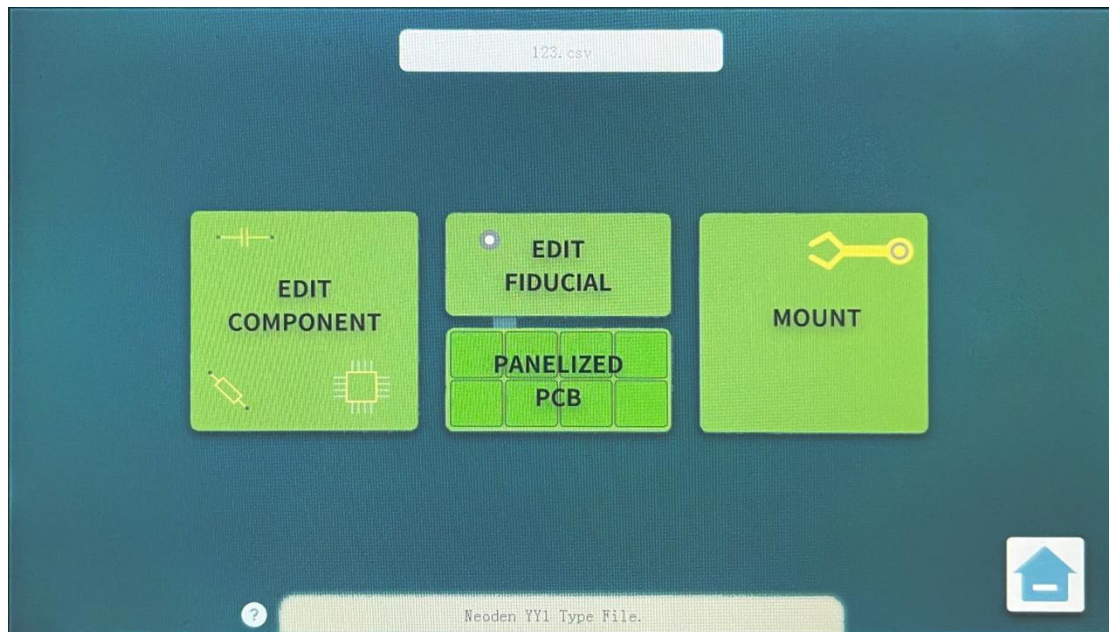

### 3.2.1 Edit Component

When you click “Edit Component”, it will turn to below interface. There’re some tips for ref. during your programming:

1. All information in this area is related to feeder, generally for same kind of footprint setting, you can directly click “Apply all same components”, then the six parameters in this area will be workable for all of the same footprint.
2. You can modify parameters of the components one by one, and you can also modify the parameters by using “Apply all same components” to realize modify the same kind footprint components quickly.
3. If the component specifications are the same and the component footprint is also same, they will be classified as the same type of components.
4. There are five recognition modes: 0 (Null), 1 (Camera), 2 (Vacuum), 3 (Camera+ Vacuum), 4 (Big IC Camera). You can select the applicable mode for different components to realize a balance between speed and accuracy. When you select 4, the field of view area will be enlarged. Please make sure there’s no direct- light above the machine otherwise it will affect the recognition, you can cover something on the machine to escape the direct light.

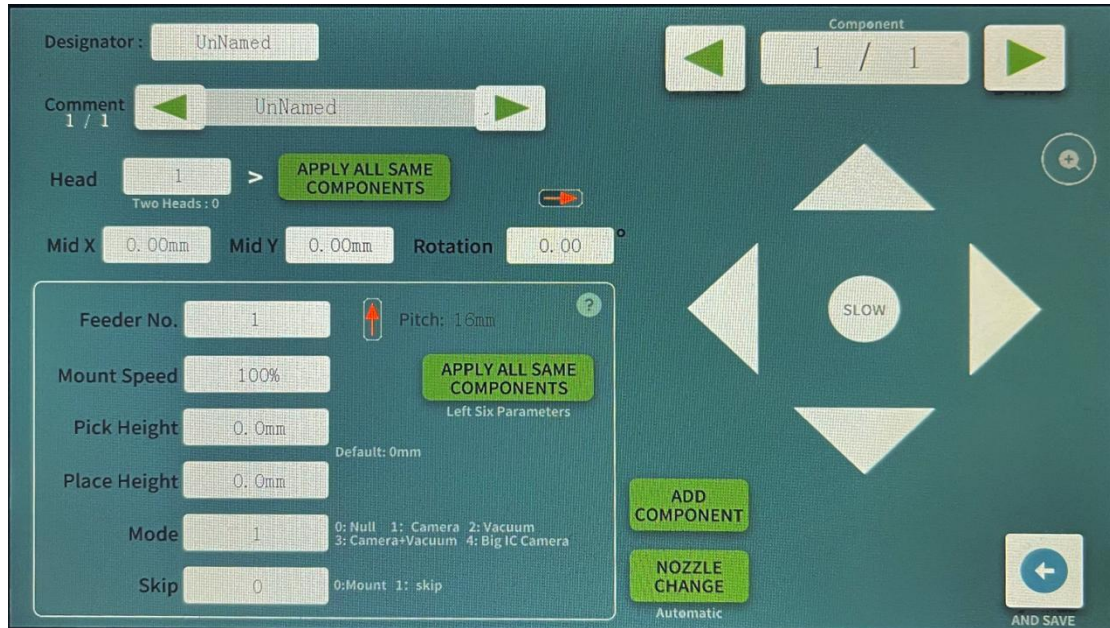

### 3.2.2 Edit Fiducial

PCB will be fixed manually by the magnetic pin or bars and you also need to set a fiducial for helping recognition. Some tips for setting fiducials:

1. Fiducial requirement: round shape, it could be pads or holes with high contrast to the surrounding area (observed in the camera). You will hear a ticking sound if the machine fails to recognize fiducials, you can try to replace to a more suitable one. It will be generated as fiducial once it succeeds.
2. Please avoid any similar round shapes near the fiducials to avoid confusion, otherwise the machine will take the other one as a fiducial.
3. Inaccurate setting of fiducials will result in overall offset in the same direction.
4. In Step1, if it's not easy to observe the center of the component, please press the button to move to next component until you can clearly align the center of a component.
5. If the fiducial cannot be successfully recognized during placement, you can adjust the camera threshold.

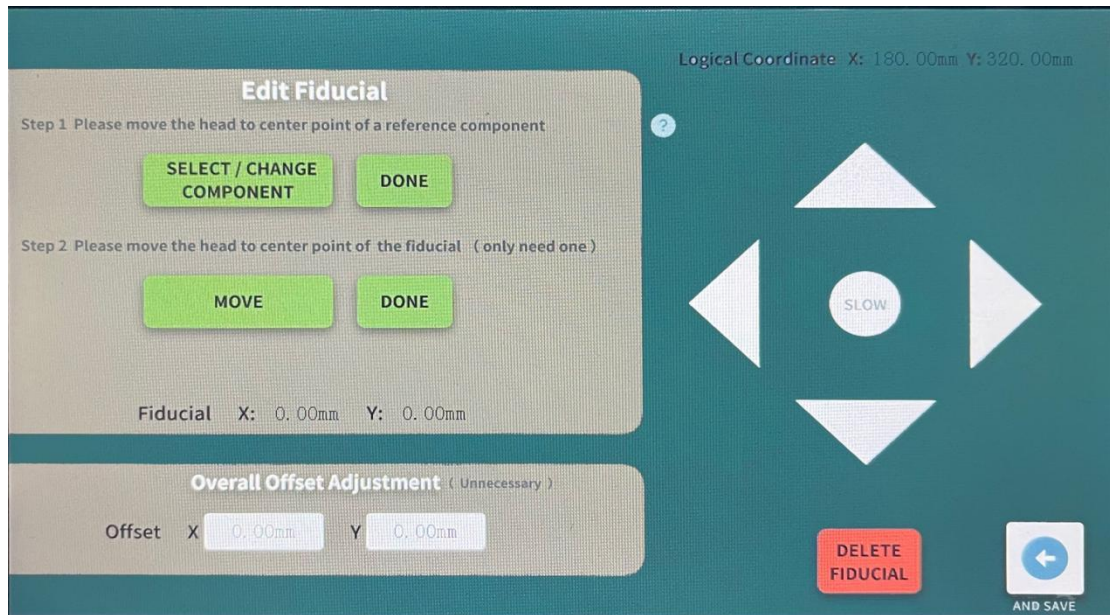

### 3.2.3 Panelized PCB

The way to set up the panelized information is very easy and intuitive. You just need to input the horizontal and vertical dimensions of the PCB, and the number of panels in horizontal and vertical directions.

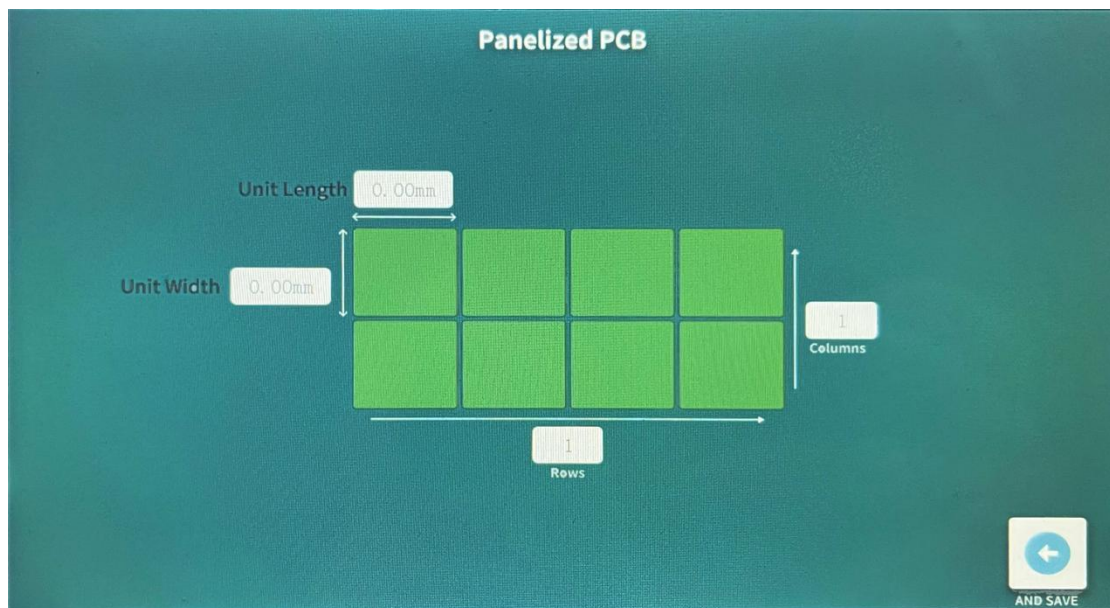

### 3.2.4 Mount

After you click Mount button, it will enter this interface.

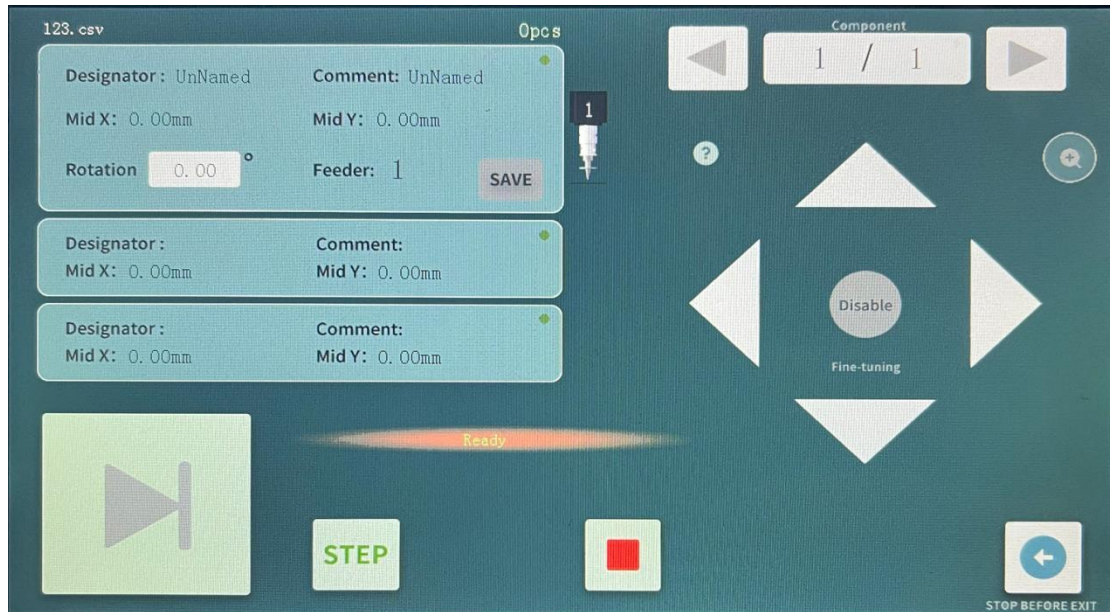

1. Press Step button to enter the Preview mode, then the related buttons will turn green (active).



2. If you have set fiducial, the machine will go to recognize the fiducial before entering the Preview mode after clicking Step button.

3. In the Preview mode, press the Align or  buttons to locate the corresponding component, you can also directly enter the designator to quickly locate the desired component.

4. In the Preview mode, you can press the Up, Down, Left and Right buttons to fine-tune the component position. Pressing the Save button will save all the adjustments made this time. The rotation of the current component can also be adjusted.

5. In the Preview mode, input the designator and then continue to mount, it will start to mount from this component. This function can realize to start mounting from midway or mount a certain individual component.

6. Sometimes the machine will have unavoidable mechanical offset, causing the deviation between image position and the actual placement position, so the fine-tune is more concerned about how much it has been off, not necessarily the center point of the image is aligned with the center of the component.

7. Please avoid similar round shapes near fiducials to avoid confusion, otherwise the machine will take the other one as fiducial.

### 3.3 Manual Test

Click the orange button in the home to enter the Manual Test interface.

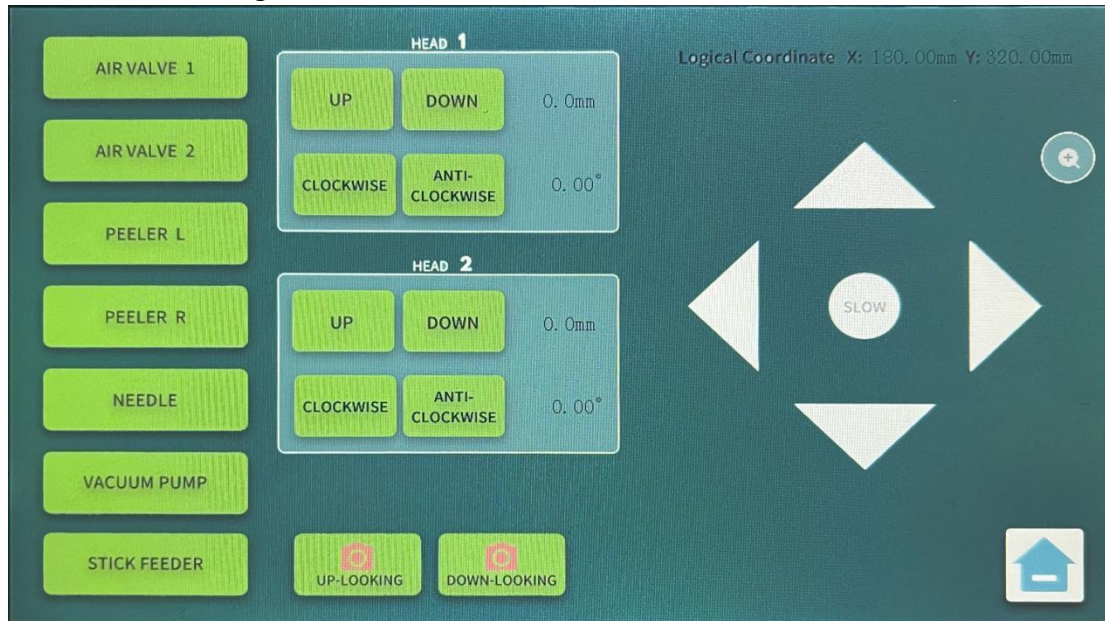

You can click any buttons in this interface to test if each module is functional.

(1)AIR VALVE 1/AIR VALVE 2: used to check if the valves are working.Please click to open the vacuum pump before testing the air valves.

(2)PEEL L/PEEL R: used to check if the peeling gadgets are working normally

(3)FEEDER NEEDLE: used to check if the needle module could move down and bounce back smoothly.

(4)VACUUM PUMP: you can open/close the vacuum pump by clicking this button;

(5)VIBRATOR: used to check if the stick feeder could vibrate and feed components;

(6)UP-LOOKING CAMERA/DOWN-LOOKING CAMERA: click to test the photograph, and the photos will be displayed in the screens.

(7)Head 1/Head 2: Click UP, DOWN, FORWARD and REVERSE to check if the nozzles could move up/down and rotate clockwise/anticlockwisely correctly.

(8)XY LOGICAL COORDINATE :click to display the real-time position of head.

Click the triangles to control the left, right, up and down movement of the head. Change the movement speed by clicking the round mark. To click + to zoom in and zoom out.

### 3.4 Feeder Settings

YY1 supports various types of feeder package, including: tape reel feeder, tube feeder, tray feeder, bulk feeder and strip feeder.

The feeder setting include three main sections: tape reel feeder, flexible feeder and bulk feeder.

#### 3.4.1 Tape Feeder

You can enter the following interface for tape reel feeder setup. No 1-52 belong to tape reel feeder. Press the left or right button to select feeder, or directly enter feeder number you want to edit manually.

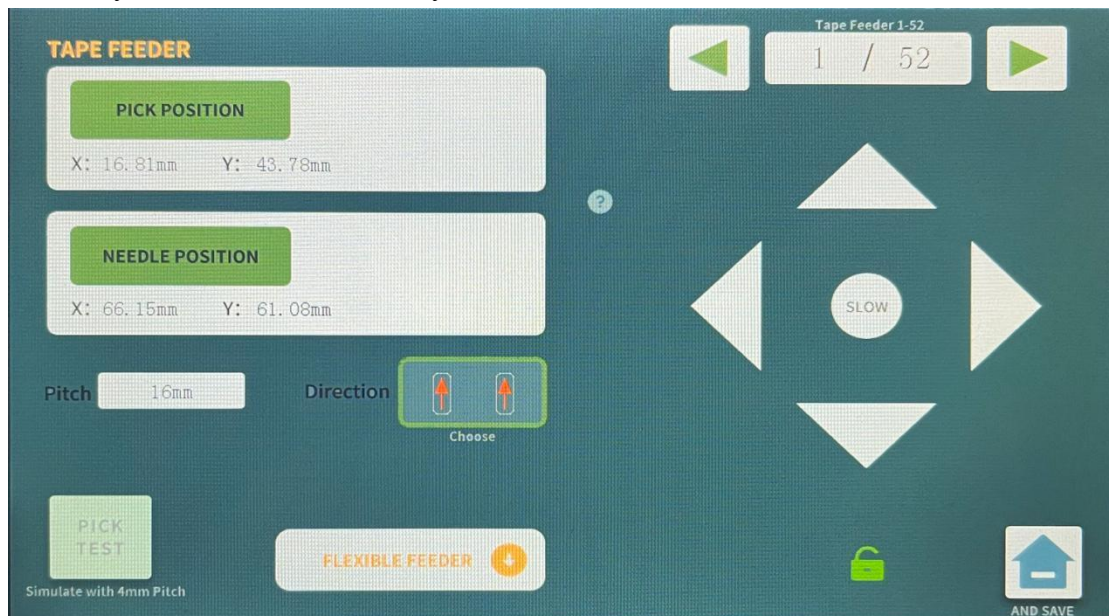

1. General procedure for the tape feeder setup is firstly set the needle position, then click the Pick test button, and finally click Pick Position to determine the pick-up position. The reason for this order is that different material and thickness of tapes have different gaps in the holes, so when the component is fed, you may find that the position of the needle is not the original position.

2. Direction means the initial angle of the component in the tape, there are four angles when you can select by clicking on them.

3. For very small components like 0402, 0201, please set the pick-up position as close as possible to where it just comes out. This will increase the success rate of the outfeed.

4. When both heads are working on same kind of components at the same time and the DEV of the component is 4mm, the needle will advance two component at a time. Again, set the pick-up position closer to where they come out will increase the success rate of the outfeed. It is not recommended to work in this way with components that are too small.

5. Pick test is used to test the results of the feeder setting, only for simulating pick the component, nozzle will not pick it.

### 3.4.2 Flexible Feeder

You can enter the following interface for flexible feeder setup. No 53-80 belong to the flexible Feeder, press the left and right button to select the feeder, or directly enter the feeder number you want to edit manually.

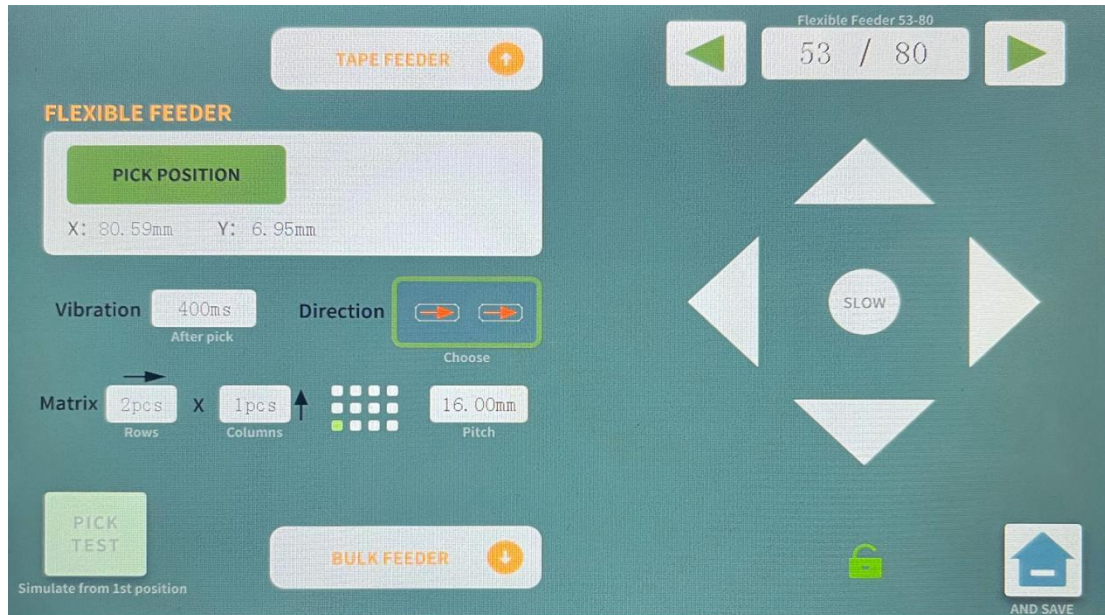

1. Flexible feeder include vibration feeder, IC tray feeder, strip feeder and customized IC tray feeder. All parameters are edited under this page.
2. Vibration parameters are related to vibration feeder, the general setting range is between 1000ms-5000ms, other feeders no need set this parameter.
3. Direction means the initial angle of the component in the tape, there are four angles which you can select by clicking on them.
4. The strip feeder belongs to flexible feeder, when set the matrix parameters, the number of verticals is 1, the number of horizontals is the number of components, and input correct spacing.

### 3.4.3 Bulk Feeder

You can enter the following interface for tape reel feeder setup. No 81-99 belong to bulk feeder. Press the left or right button to select feeder, or directly enter feeder number you want to edit manually.

1. Bulk feeder means that you can use the down-looking camera to look at and find loose components and pick them up for placement.
2. The area of the pick position of the Bulk Feeder should be dark in color and should not have bright color that interfere with the recognition of the camera.
3. The loose components must not overlap, must not be tightly packed together, and must not be a device such as an IC.
4. The Camera Threshold parameter can be set to make the recognition better. It is necessary to observe on the camera screen that each component is recognized as a



complete block of color and the number of components is also visible on the camera screen(maximum display 10).

5. It is still in beta version,there is a small chance that the position or angle may be wrong,so please check after placement.

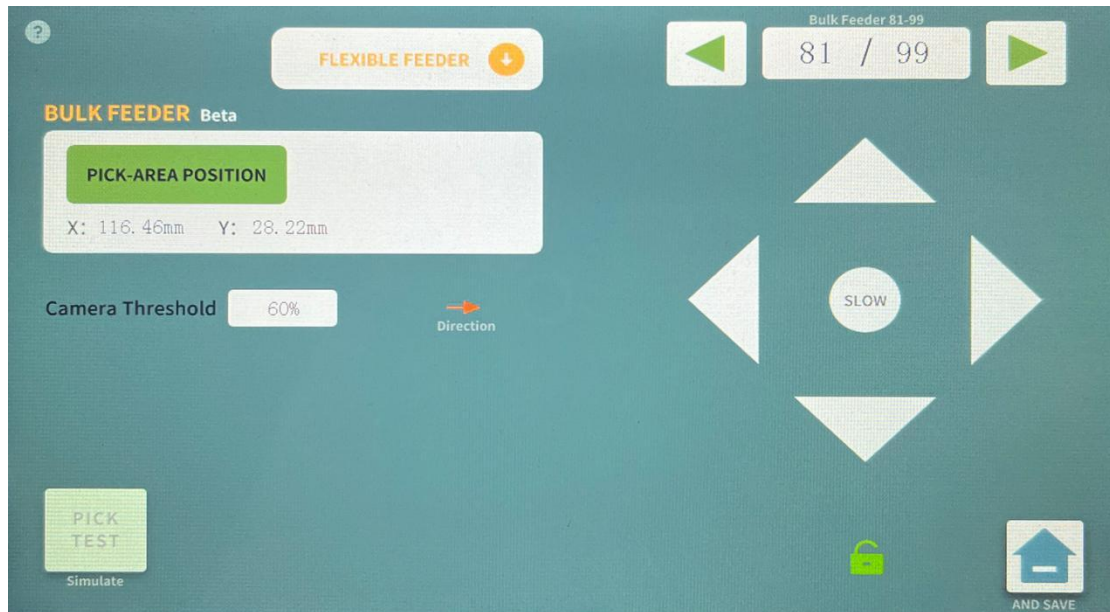

## 3.5 System Parameters

Click the orange button at the bottom right of the main page to access the system setting interface as shown below.

Please note: Any wrong parameter setting may cause the device to work improperly or reduce accuracy.

The password is the chronological version of the machine, e.g. YY1 2022 version The password is 2022. The password is only used for avoiding mis-operation.

After the first successful entry, the system will save the password and there is no need to enter it again next time.

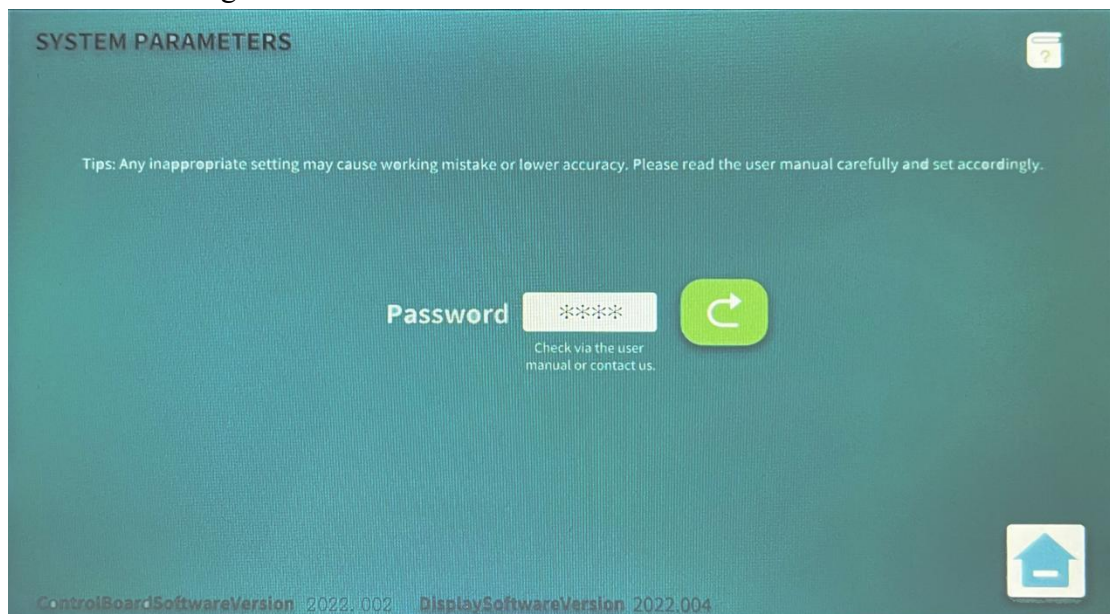

### 3.5.1 Basic Parameters

Click the button Parameters, then entering the password, you'll get the page as below.

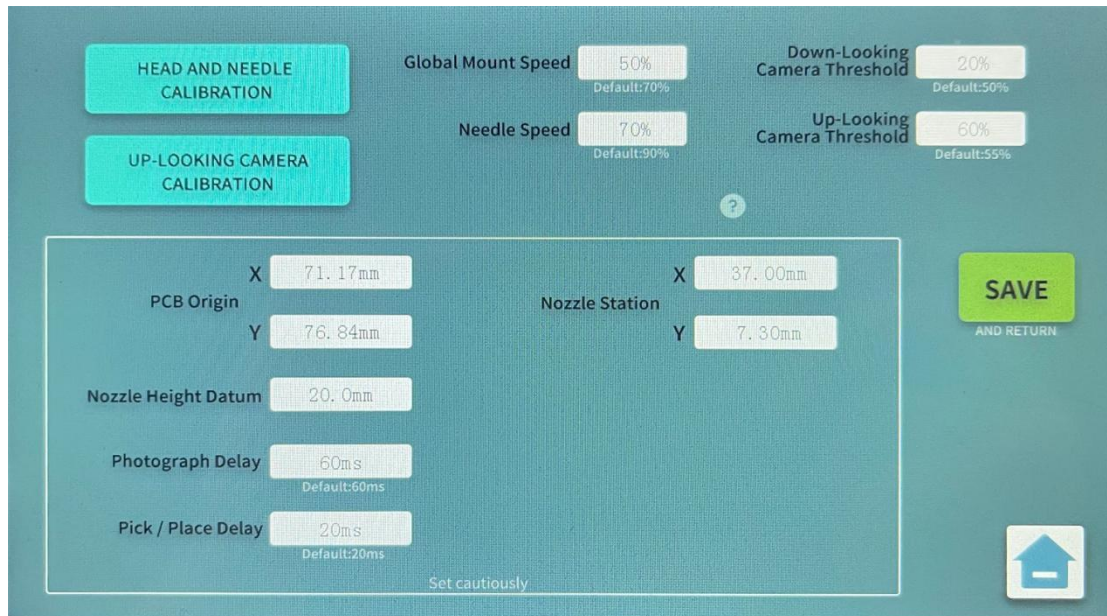

1.Global speed will be changed if the setting revised by Global Mount Speed setting.The mount speed will be changed pro-rata if there is a speed value was setted in the working file already.Default value should be 70%,there may be some movement noise if the speed value be revised too high,better please set it based on actual request.

2.Needle Speed means the single speed for needle only,better please set it based on actual request,the best will be below 90% if high speed is not necessary,as some of the tape reels not applicable for high speed.

3.Camera Threshoud is one of the most important parameters.CPU will generate the original image to be binary one during the image generation process,0 means white,1 means black,CPU just can recognize and calculate the same image as showed as Figure A.This parameter means how the lightness can be setted as white,it mostly should be white if the value less,the generation process can be viewed on the screen of camera.

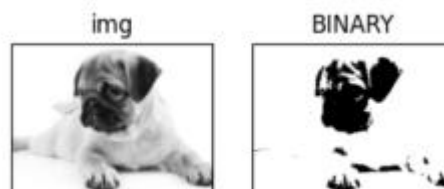

Figure A

4.PCB Origin means the left bottom corner of PCB,it will be used to change the positions either the fixation position or fine adjustment.In the manual test,it is easy to obtain the coordinates data by moving the placement head.

5.Nozzle Height Datum means the basic depth value of nozzle drop-down,the basis

should be the height once the nozzle reached the component of the tape reel. Meanwhile, the basis data can be obtained in the manual test by move the nozzle manually.

6. Photograph Delay means how long the camera waiting to photograph after the component move above the camera, increase the time value to prevent the vibration impacts for the photograph effects.

7. Pick/place delay refers to the waiting time before picking and placing the components. Add values to the pick and place delays could improve the placement accuracy and stability.

### 3.5.2 Head and Needle Calibration

This function is applied for calibrating the two nozzles and the needle. In the accessory box, there is a small bag of black papers equipped for doing the calibrations. Also, they can be replaced by other paper which could be easily leave trails. Please follow the instructions which illustrated by the hints step by step till completed. The instructions are as below:

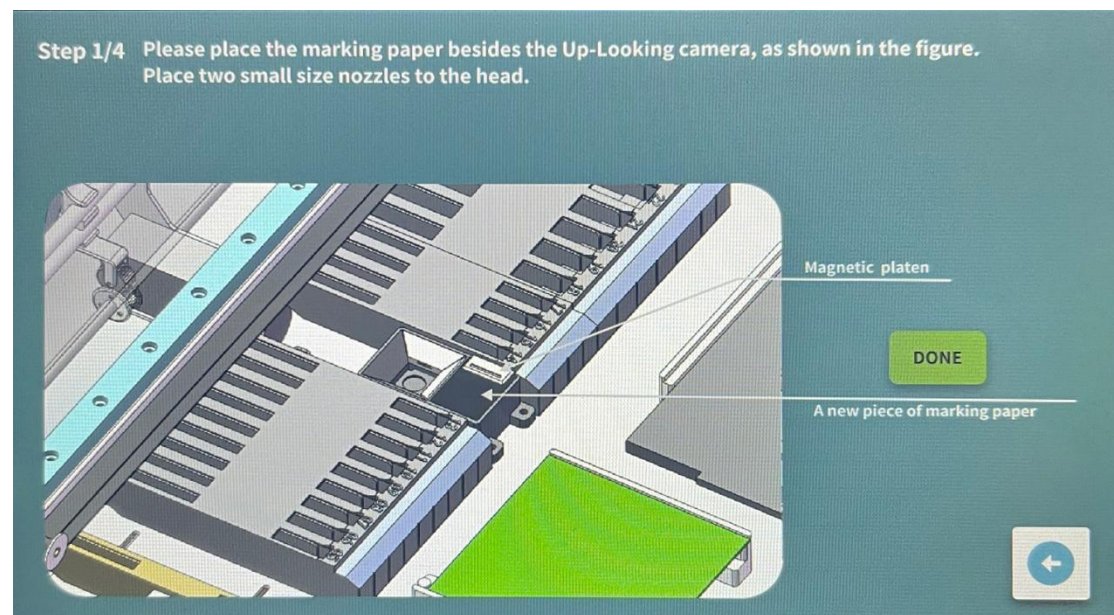

**Step 2/4** Wait for the head 1 to leave a mark on the marking paper, move the mounting head and align the crosshairs with the center of the mark.

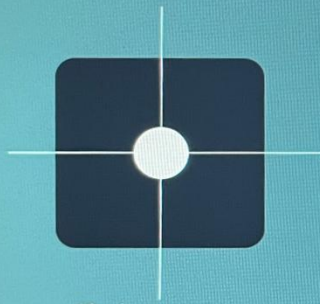

DONE

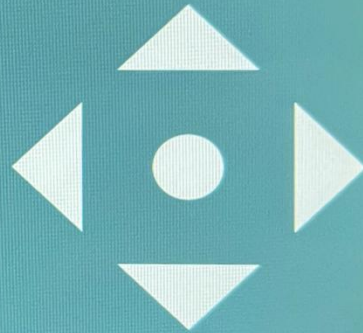

**Step 3/4** Wait for the head 2 to leave a mark on the marking paper, move the mounting head and align the crosshairs with the center of the mark.

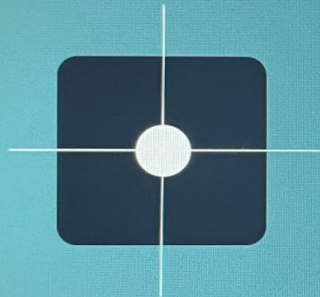

DONE

The next step will be noisy.  
Please be prepared

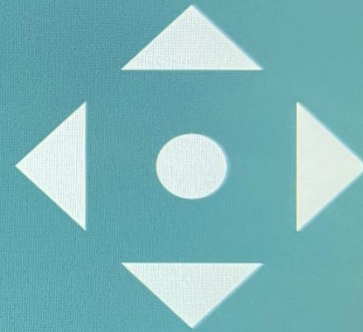

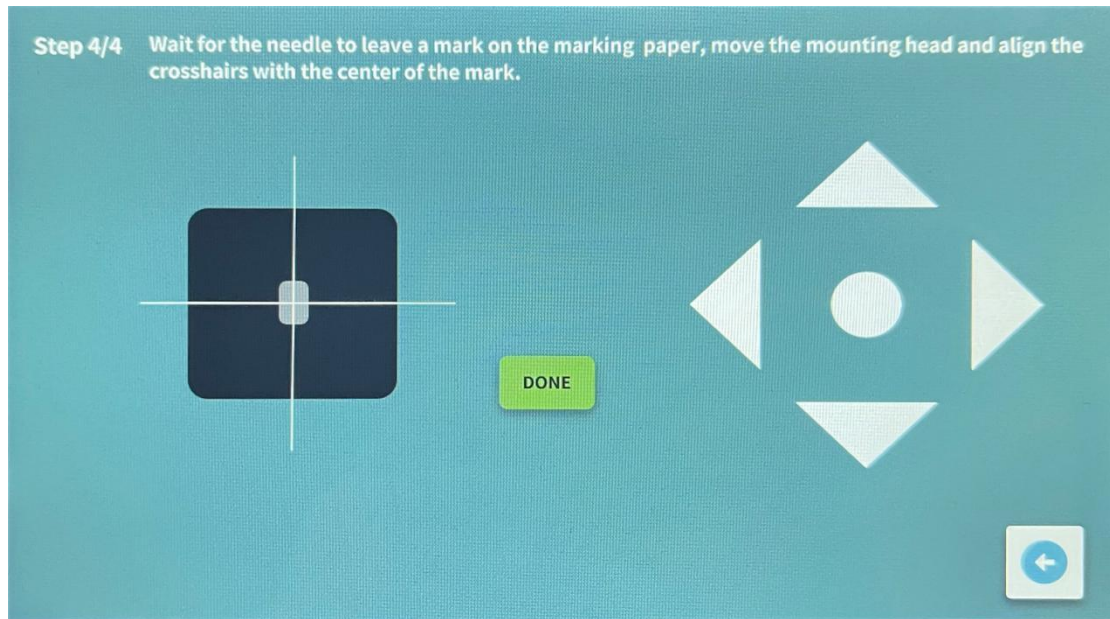

### 3.5.3 Up-looking Camera Calibration

This function is mainly used to calibrate and adjust the center position of the camera. Follow the step-by-step operation as guided by the system online until the setup is completed. The guidance diagram for this setup operation is shown below.

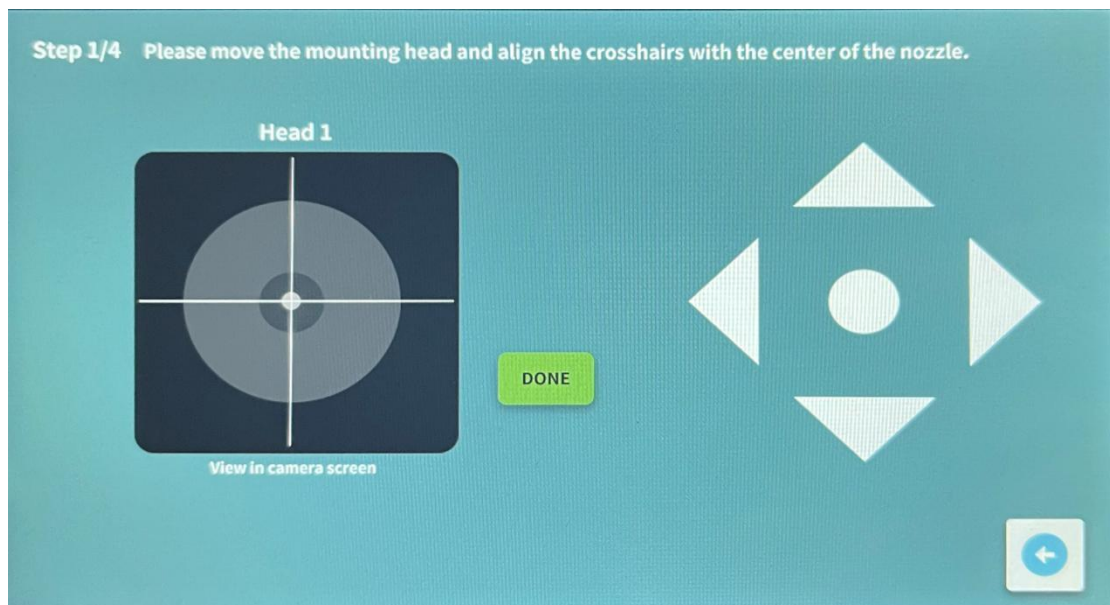

Step 2/4 The nozzle has rotated 180 degrees, please move the mounting head and align the crosshairs with the center of the nozzle again.

Head 1

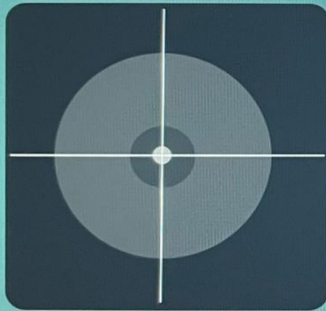

View in camera screen

DONE

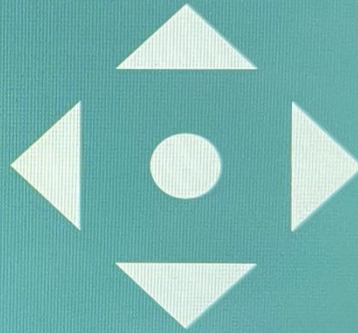

Step 3/4 Please move the mounting head and align the crosshairs with the center of the nozzle.

Head 2

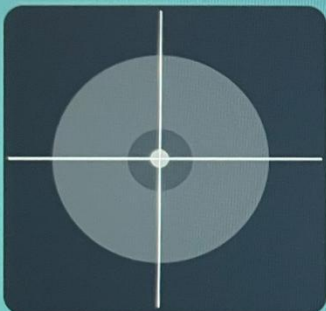

View in camera screen

DONE

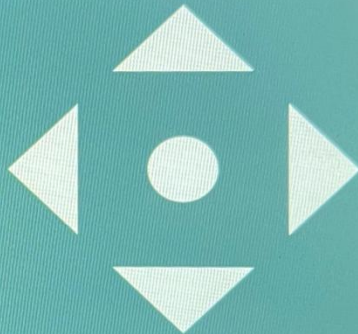

Step 4/4 The nozzle has rotated 180 degrees, please move the mounting head and align the crosshairs with the center of the nozzle again.

Head 2

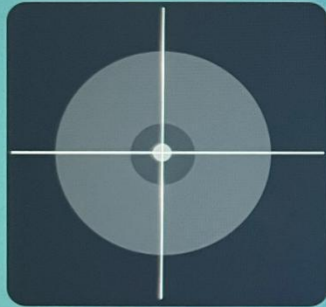

View in camera screen

DONE

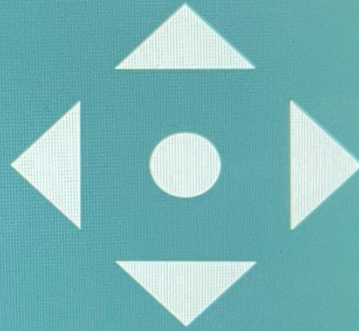

## 4. Machine Operation Introduction

NeoDen YY1 The worktable is displayed as shown below:

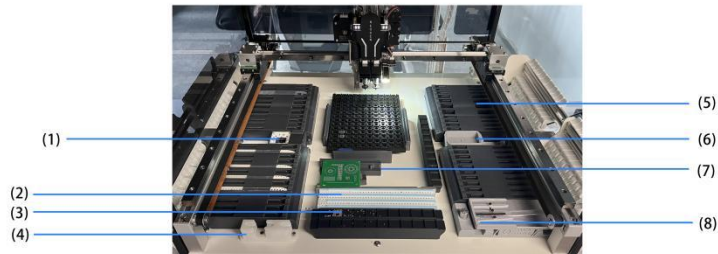

(1) Camera

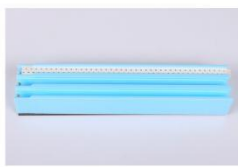

(2) Strip feeder tray

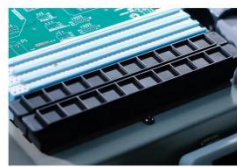

(3) bulk feeder tray



(4) nozzle change station



(5) Tape feeder



(6) Trash tray



(7) Positioning strip



(8) Stick feeder

### 4.1 PCB Fixing Methods

Some common PCBs fixing method:



01

This is the general fixing method, please well coordinate between positioning strip and PCB fixation needle.

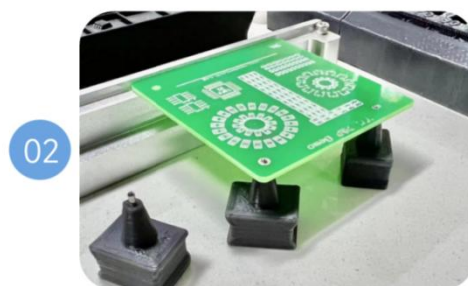

02

Use the holes on the PCB to fix.



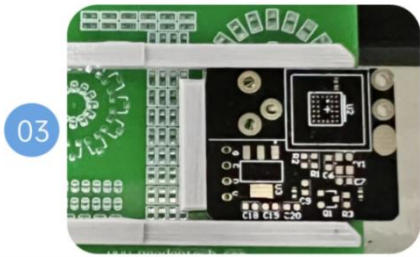

03

For small PCB, fix a base board first, paste the blocking strip on the base board to fix the PCB.



04

For particularly large PCB, remove the origin screw, on feeder block have set positioning support, for even larger PCB, if left feeder quantity is enough, remove the right side feeder.

05

First use method 1 to fix base board same as PCB which will be mounted, solder 2-3 pins on the holes of base board, use these pins to fix PCB.

06

If the PCB origin is not in the default position, you need to set the PCB origin in the system parameters. Setting method: in the manual setting page, move the camera to the new PCB origin, record the coordinates, and fill the coordinates into the PCB origin.

## 4.2 Install the Tape Reel



1

The way to fix tape&reels into the magazine.



2

The way to load tape&reels into feeders



3 Press here to unlock the feeder easily.

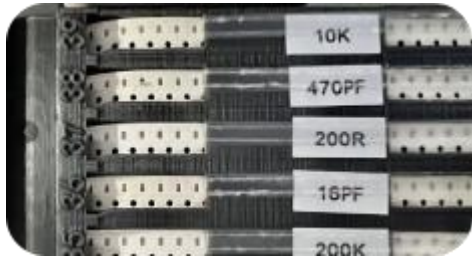

4 Tag the frequently used components to make them easier to locate.

### 4.3 Stick Feeder

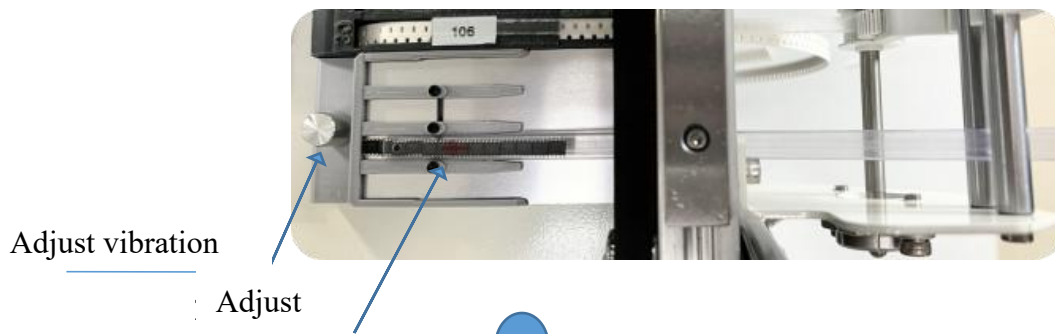

1 Installation for strip feeder



2 Adjust the tube location to make sure the component can slide out a little bit more than one chip, it will be convenient for picking up the next chip.

3 Stick feeder belongs to Flexible feeder, once the vibration time is set well, it will vibrate against that time after one chip picked. Please set applicable time and strength against real need.

#### 4.4 Short Tape Feeder

1. There is a needle in front of Strip feeder tray, but the hole of the strip into the needle, the components will be in the same position after change new strip.
2. Tear the strip film carefully.
3. The pick height of the strip is very important, have to set the pick height just above the surface of the component, if it is too low, will bring vibration to the following component. How to get the correct height: go to Manual setting page, move the nozzle to the pick-up position, drop the nozzle to the surface of the component and record the drop distance. For example, if the drop distance is 20.5mm, and the Nozzle Height Datum is 20.0mm in the setting, then you need to set pick height of this component to -0.5mm.
4. Strip feeder Tray is Flexible Feeder, set columns to 1, rows number is the number of components, set the correct Pitch.

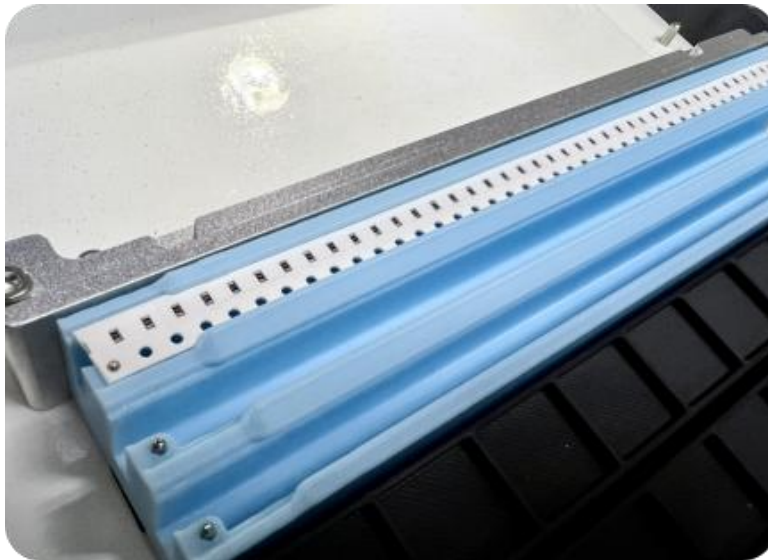





## 4.5 Nozzle and Nozzle Change

### 4.5.1 Introduction and Selection of Nozzles

In order to ensure the placement accuracy, please select nozzles according to the shape and size of components.

**Table 1-1 Nozzle**

Type	Regular	Regular	Regular	Regular	Regular	Regular	Regular	Regular
Model	CN030	CN040	CN065	CN100	CN140	CN220	CN400	CN750
Illustration								
External Diameter	0.6 mm	0.8mm	1.0mm	1.8MM	2.0mm	3.6mm	5.0mm	9.0mm
Inner Diameter	0.3 mm	0.4mm	0.7mm	1.0MM	1.4mm	2.2mm	4mm	7.5mm
Type	Special	Special	Special	Special	Special	Special	Special custom	
Model	YX01	YX02	YX03	YX04	YX05	YX06	-	
Illustration								
Shape								

### Nozzle selection reference

In order to ensure the placement accuracy, please select nozzles according to the shape and size of components.

Table 1-2 Model and minimum width comparison table

Model	Recommendation (Imperial system)
CN030	0201
CN040	0402 (optimal)
CN065	0402、0603 etc.
CN100	0805、diode、1206、1210 etc.
CN140	1206、1210、1812、2010、SOT23、5050, etc.
CN220	SOP series ICs、SOT89、SOT223、SOT252, etc.
CN400	ICs from 5 to 12mm
CN750	ICs bigger than 12mm
YX01	3528series Soft bead
YX02	High power lamp beads
YX03	Chips and BGA from 11mm to 17mm BGA
YX04	Chips and BGA bigger than 17mm
YX05	4148 circular diode
YX06	3535 ball shape LED(Spherical height 1.4mm,overall height 1.9mm)
Connector socket nozzles	FPC/FFC connector socket

Component size	Suction surface dimensions	Component size	Suction surface dimensions
0201	0.6*0.3	0402	1.0*0.5
0603	1.6*0.8	0805	2.0*1.2
1206	3.2*1.6	1210	3.2*2.5
1812	4.5*3.2	2010	5.0*2.5
SMA	4.0*2.5	SMB	4.0*3.3
SMC	6.6*5.6	SOT23	3*1.4
SOT89	4.5*2.5	SOT223	6.4*3.7
TO252	6.5*6.3		

## 4.5.2 Auto Nozzle Change

The auto nozzle change device is located at the left front of the machine operator's console, as shown in the picture below.

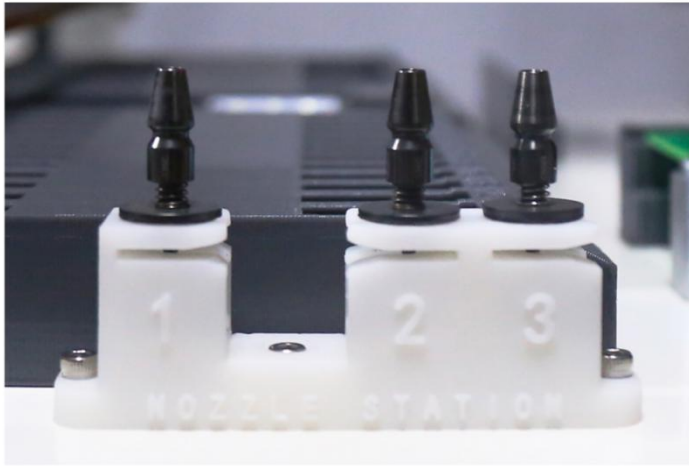

The auto nozzle change settings page, as shown below.

**AUTO NOZZLE CHANGE**

	BeforeComponent	Head 1,2		Drop To 1,2,3		Pick Up 1,2,3
<input type="checkbox"/>	55 C1	1	First	1	Then	2
<input type="checkbox"/>	56 C1	2	First	2	Then	3
<input type="checkbox"/>	1 R4	1	First	1	Then	1
<input type="checkbox"/>	1 R4	1	First	1	Then	1

Tips: Each file supports up to 4 nozzle changes. Please check the file carefully to ensure that the suction nozzle station to be placed is empty to avoid collision.

1. The head can be fitted with two nozzles at the same time and the nozzle station can also accommodate two nozzles, so it can support four different nozzle types at the same time in an uninterrupted placement process.
2. The information to be entered on the nozzle replacement setting page are: the nozzle to be replaced before which component, which placement head nozzle to be replaced, where to put the original nozzle at nozzle station, which nozzle to be taken from nozzle station.
3. Caution! When setting where to put the original nozzle to the nozzle station, you need to ensure that the nozzle station position is vacant to avoid collision damage to the nozzle and placement head.
4. If during mounting process, nozzle replacement action more than once, then after

complete mounting file, please check whether every nozzle replacement action are set correctly. The next nozzle is placed at the station where the previous nozzle was sucked away and left vacant position.

When machine is running, you can visually see the real-time display value of air pressure on the upper two ends of the placement head and the two light strips on the outer housing, to judge the state of vacuum detection and working condition, as shown in the below picture.

#### 4.6 Vacuum Detection Module

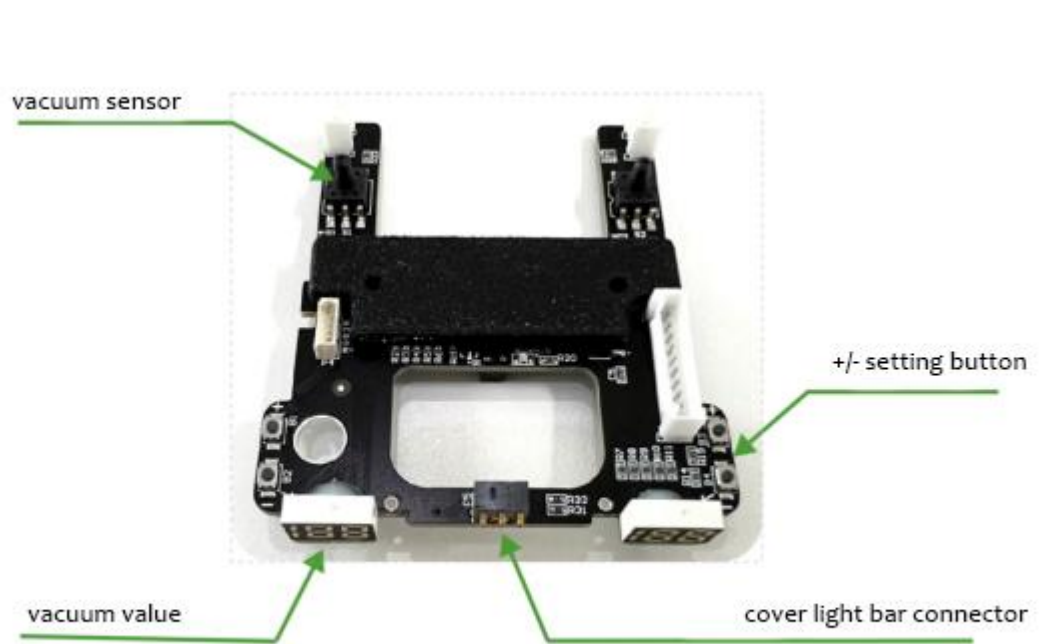

The vacuum detection module of this machine is mainly presented on the mounting head and the structure is shown in the diagram above.

1. Short press the +/- button to adjust the comparison vacuum value, the collected vacuum value will compare with set vacuum value , to determine whether the vacuum detection pass or not
2. Long press the +/- button can be calibrated, already been calibrated in the factory, users generally do not use this function. Turn off the solenoid valve, long press the "-" button, set the vacuum value to 0. Turn on the vacuum pump and the solenoid valve, press the air pipe hardly, long press the "+" button, set the current vacuum vale to 100
3. When the vacuum detection is passed, the corresponding light bar on the cover will light up

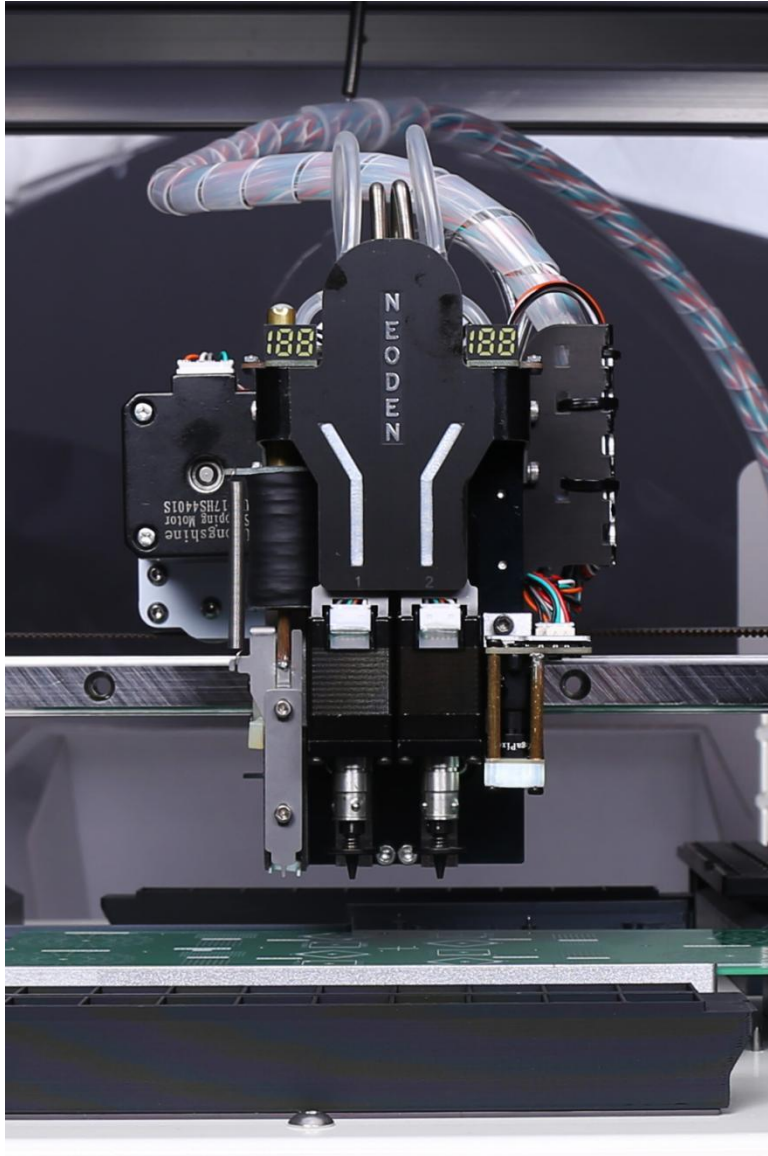

When the vacuum test is on, the corresponding light strip on the outer housing will light up, as shown in the below picture.





## 4.7 Trash Box

The trash box is located on the workbench of the machine. It can be easily picked up or installed under the condition of safety. Please note the direction when installing the waste box, with the arrow pointing upwards.



## 4.8 Magnetic Acrylic Cover

The acrylic front cover of NeoDen YY1 can be opened and turned up as shown in the picture, which is convenient for observation and workbench operation. Please put the cover down before the machine starts to mount to ensure the safe use.



The acrylic cover of the machine has a magnetic design, easy to disassemble and install, as shown in the picture below.



## 5. Machine Adjustment Guide and Maintenance

### 5.1 How to Adjust the Peeling Torque



1

After removing these two screws, the damping wheel can be easily removed or installed in sequence.

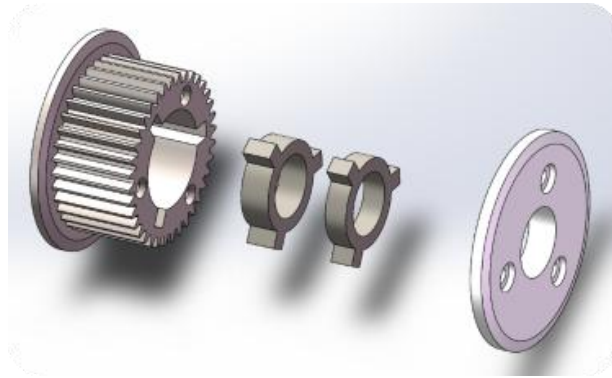

2

A damping ring with 2.5N torque is placed in the damping wheel. If you want to reduce the torque, you can replace it with the damping ring with 1.5N torque. If you want to increase the torque, you can also put two damping rings. It needs to be adjusted only for very special tapes.

### 5.2 How to Adjust the Shrapnel of Tape Reel Feeder

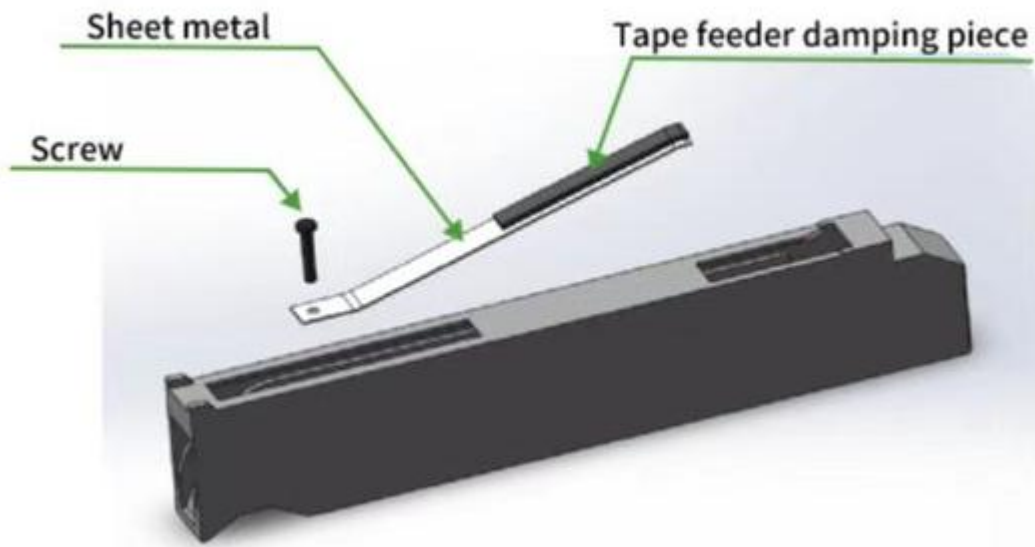

1. Sheet metal is used to press the tape to make sure tape without any movement.
2. Tape feeder damping piece is used to increase friction and reduce vibration.
3. If component is very thick, you can try to lower the sheet metal pressure like this: loosen the screw a little bit or take off the sheet metal and use some tool to change its

shape.

4. If you need the sheet metal with bigger pressure, you can use some tool to make it more bend.

5. Long time use will bring the tape feeder damping piece serious abrasion and lead to friction disabled, please replace new tape feeder damping piece.

## 5.3 How to Adjust the Belt Tightness

1 Automatic preloading springs are installed on the X and Y axis belts. Under normal circumstances, there is no need to adjust the belts within a certain range.



2 Adjust X axis belt tension: Loosen the two screws of the belt fixing seat on the left or right side of the X axis. The fixing seat can be moved left and right to adjust.

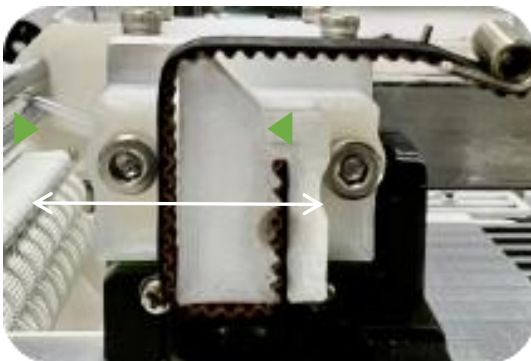

3 Adjust Y axis belt tension easily.

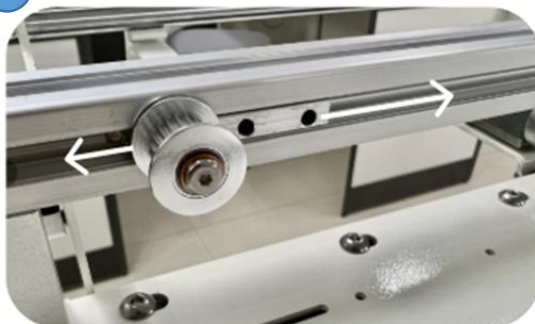

4 As shown in below pictures, you can easily remove or install the Y axis belt or X axis belt. There is a groove in the middle of the X axis belt seat for the use of

the small pliers tool. If the belt is loose, you can cut off a section of the belt and reinstall it.



## 5.4 Daily Maintenance

SMT Pick and Place machine is a relatively complex high-tech and high-precision machine, which requires working in a constant temperature, humidity and very clean environment, and maintaining the habit of regular maintenance.

- Operators should read the user manual carefully to understand the correct use of the machine and its parts.
- Operate in strict accordance with the operating rules of the machine. It is not allowed to operate the machine if there is something with the machine. If a fault is found, the machine should be stopped in time, and reported to the technical personnel or equipment maintenance personnel, and it can be used only after the fault is eliminated.
- The operator is required to concentrate on the operation process with eyes attendance, ears attendance and hands attendance.
  - ◆Eyes attendance---Observe whether there is any abnormal phenomena when the machine running. For example, the peeling device does not work, the plastic tape is broken, and the placement position is not correct.
  - ◆Ears attendance---Listen to machine running and see whether there is any abnormal sound, such as the abnormal sound of the placement head, the abnormal sound of missing components, the abnormal sound of the transmitter, the abnormal sound of the scissors, etc.
  - ◆Hands attendance--If any abnormal phenomena is found, it should be solved in time. Some small problems can be solved by the operator themselves, such as solving the problem of pulling needle stuck and correcting the placement position. If there is something wrong with the machinery and circuit, be sure to ask the maintenance personnel to check and repair.