

## LM710 Voltage Comparator

### General Description

The LM710 series are high-speed voltage comparators intended for use as an accurate, low-level digital level sensor or as a replacement for operational amplifiers in comparator applications where speed is of prime importance. The circuit has a differential input and a single-ended output, with saturated output levels compatible with practically all types of integrated logic.

The device is built on a single silicon chip which insures low offset and thermal drift. The use of a minimum number of stages along with minority-carrier lifetime control (gold doping) makes the circuit much faster than operational amplifiers in saturating comparator applications. In fact, the low

stray and wiring capacitances that can be realized with monolithic construction make the device difficult to duplicate with discrete components operating at equivalent power levels.

The LM710 series are useful as pulse height discriminators, voltage comparators in high-speed A/D converters or go, no-go detectors in automatic test equipment. They also have applications in digital systems as an adjustable-threshold line receiver or an interface between logic types. In addition, the low cost of the units suggests them for applications replacing relatively simple discrete component circuitry.

### Schematic and Connection Diagrams

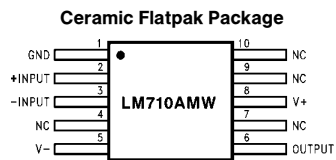
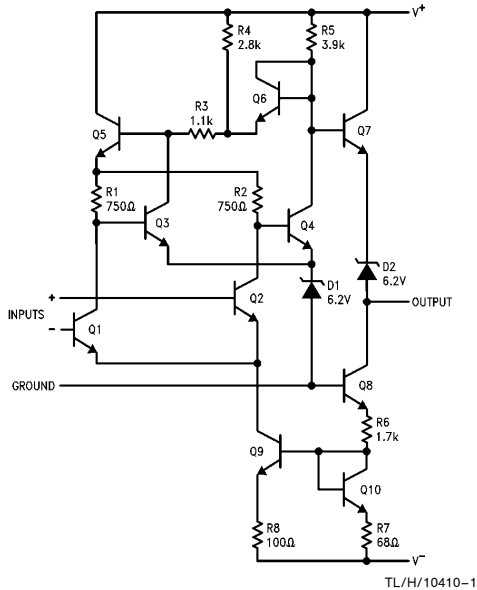

**Order Number LM710AMW/883\***  
See NS Package Number W10A

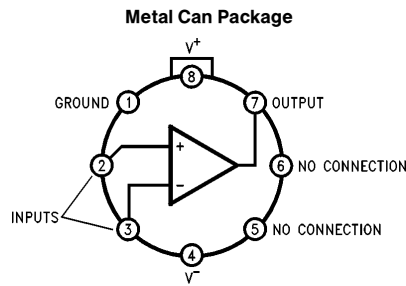

**Note:** Pin 4 is connected to case.

**Order Number LM710AMH/883\*, LM710H,  
LM710H/883 or LM710CH**  
See NS Package Number H08C

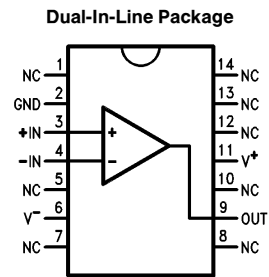

**Order Number  
LM710AMJ/883\* or LM710CN**  
See NS Package Number N14A or J14A

\*Also available per JM38510/10301

## Absolute Maximum Ratings

If Military/Aerospace specified devices are required, please contact the National Semiconductor Sales Office/Distributors for availability and specifications.

Positive Supply Voltage	+14V
Negative Supply Voltage	-7V
Peak Output Current	10 mA
Output Short Circuit Duration	10 seconds
Differential Input Voltage	±5V
Input Voltage	±7V

Power Dissipation	
TO-99 (Note 1)	700 mW
Plastic Dual-In-Line Package (Note 2)	950 mW
Operating Temperature Range	
LM710	-55°C to +125°C
LM710C	0°C to +70°C
Storage Temperature Range	-65°C to +150°C
Lead Temperature (Soldering, 10 sec.)	260°C

## Electrical Characteristics (Note 3)

Parameter	Conditions	LM710			LM710C			Units
		Min	Typ	Max	Min	Typ	Max	
Input Offset Voltage	$R_S \leq 200\Omega$ , $V_{CM} = 0V$ , $T_A = 25^\circ C$		0.6	2.0		1.6	5.0	mV
Input Offset Current	$V_{OUT} = 1.4V$ , $T_A = 25^\circ C$		0.75	3.0		1.8	5.0	$\mu A$
Input Bias Current	$T_A = 25^\circ C$		13	20		16	25	$\mu A$
Voltage Gain	$T_A = 25^\circ C$	1250	1700		1000	1500		
Output Resistance	$T_A = 25^\circ C$		200			200		$\Omega$
Output Sink Current	$V_{OUT} = 0$ , $T_A = 25^\circ C$ $\Delta V_{IN} \geq 5 mV$ $\Delta V_{IN} \geq 10 mV$	2.0	2.5		1.6	2.5		$\mu A$ mA
Response Time	$T_A = 25^\circ C$ (Note 4)		40			40		ns
Input Offset Voltage	$R_S \leq 200\Omega$ , $V_{CM} = 0V$			3.0			6.5	mV
Average Temperature Coefficient of Input Offset Voltage	$T_{MIN} \leq T_A \leq T_{MAX}$ $R_S \leq 50\Omega$		3.0	10		5.0	20	$\mu V/^\circ C$
Input Offset Current	$T_A = T_{A MAX}$ $T_A = T_{A MIN}$		0.25 1.8	3.0 7.0			7.5 7.5	$\mu A$ $\mu A$
Average Temperature Coefficient of Input Offset Current	$25^\circ C \leq T_A \leq T_{MAX}$ $T_{MIN} \leq T_A \leq 25^\circ C$		5.0 15	25 75		15 24	50 100	nA/ $^\circ C$ nA/ $^\circ C$
Input Bias Current	$T_A = T_{MIN}$		27	45		25	40	$\mu A$
Input Voltage Range	$V^- = -7V$	±5.0			±5.0			V
Common-Mode Rejection Ratio	$R_S \leq 200\Omega$	80	100		70	98		dB
Differential Input Voltage Range		±5.0			±5.0			V
Voltage Gain		1000			800			V/V
Positive Output Level	$-5 mA \leq I_{OUT} \leq 0$ $V_{IN} \geq 5 mV$ $V_{IN} \geq 10 mV$	2.5	3.2	4.0	2.5	3.2	4.0	V V
Negative Output Level	$V_{IN} \geq 5 mV$ $V_{IN} \geq 10 mV$	-1.0	-0.5	0	-1.0	-0.5	0	V V
Output Sink Current	$V_{IN} \geq 5 mV$ , $V_{OUT} = 0$ $T_A = 125^\circ C$ $T_A = -55^\circ C$	0.5 1.0	1.7 2.3					$\mu A$ mA
	$V_{IN} \geq 10 mV$ , $V_{OUT} = 0$ $0^\circ C \leq T_A \leq +70^\circ C$				0.5			$\mu A$

## Electrical Characteristics (Note 3) (Continued)

Parameter	Conditions	LM710			LM710C			Units
		Min	Typ	Max	Min	Typ	Max	
Positive Supply Current	$V_{IN} \geq 5 \text{ mV}$		5.2	9.0				mA
	$V_{IN} \geq 10 \text{ mV}$					5.2	9.0	mA
Negative Supply Current	$V_{IN} \geq 5 \text{ mV}$		4.6	7.0				mA
	$V_{IN} \geq 10 \text{ mV}$					4.6	7.0	mA
Power Consumption	$I_{OUT} = 0$							mW
	$V_{IN} \geq 5 \text{ mV}$		90	150				mW
	$V_{IN} \geq 10 \text{ mV}$						150	mW

**Note 1:** Rating applies for ambient temperatures of 25°C; derate linearly at 5.6 mW/°C for ambient temperatures above 25°C.

**Note 2:** Derate linearly at 9.5 mW/°C for ambient temperatures above 25°C.

**Note 3:** These specifications apply for  $V^+ = 12\text{V}$ ,  $V^- = -6\text{V}$ ,  $-55^\circ\text{C} \leq T_A \leq +125^\circ\text{C}$  for LM710 and  $0^\circ\text{C} \leq T_A \leq +70^\circ\text{C}$  for LM710C unless otherwise specified: The input offset voltage and input offset current (see definitions) are specified for a logic threshold voltage of 1.8V at  $-55^\circ\text{C}$ , 1.4V at  $25^\circ\text{C}$ , and 1V at  $125^\circ\text{C}$  for LM710 and 1.5V at  $0^\circ\text{C}$ , 1.4V at  $25^\circ\text{C}$ , and 1.2V at  $70^\circ\text{C}$  for LM710C.

**Note 4:** The response time specified (see definitions) is for a 100 mV input step with 5 mV overdrive (LM710) or a 10 mV overdrive (LM710C).

## Typical Applications

Schmitt Trigger

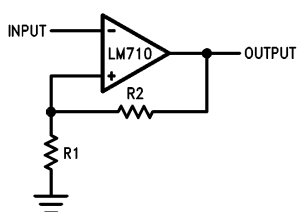

TL/H/10410-4

Line Receive with Increased Output Sink Current

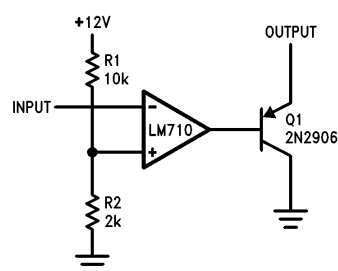

TL/H/10410-5

Pulse Width Modulator

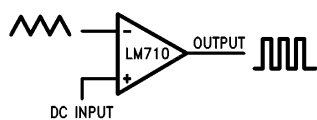

TL/H/10410-6

Level Detector with Lamp Driver

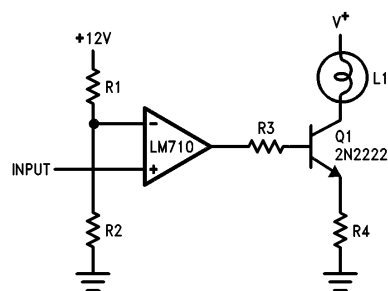

TL/H/10410-7

# Typical Performance Characteristics

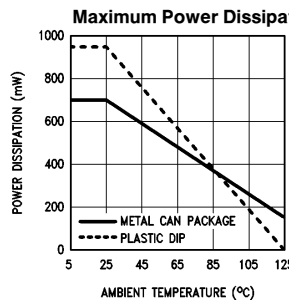
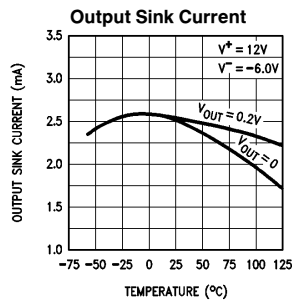
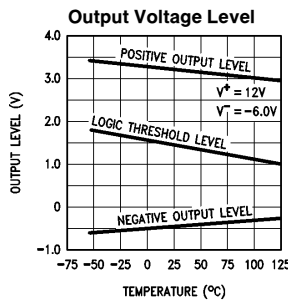
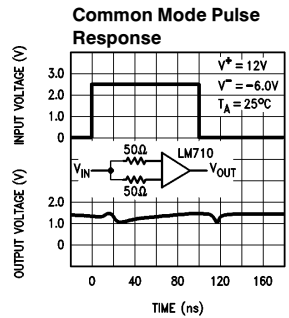
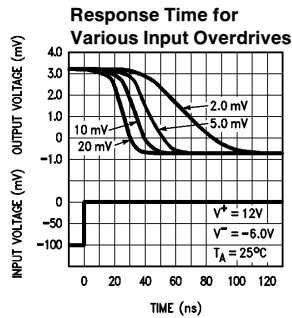
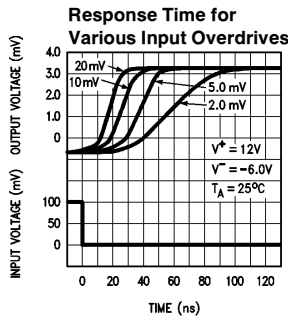
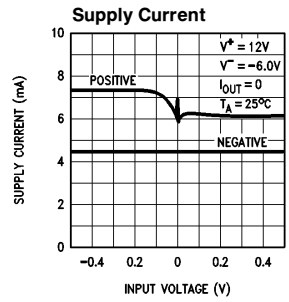
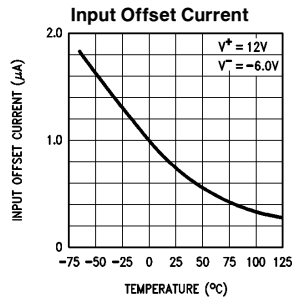
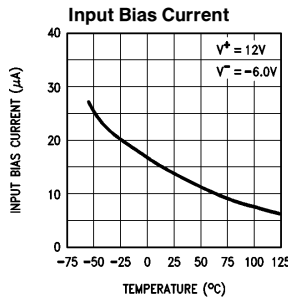
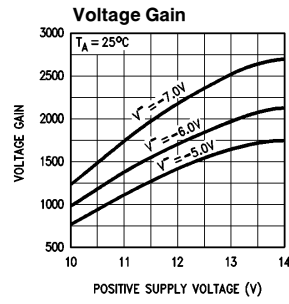
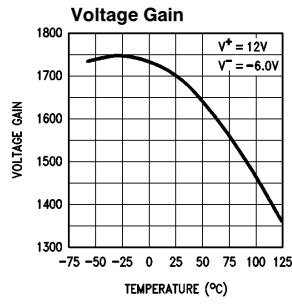
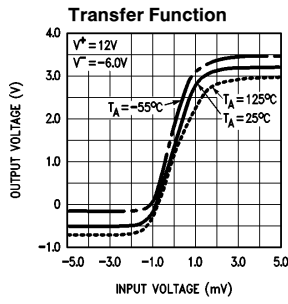

TL/H/10410-8

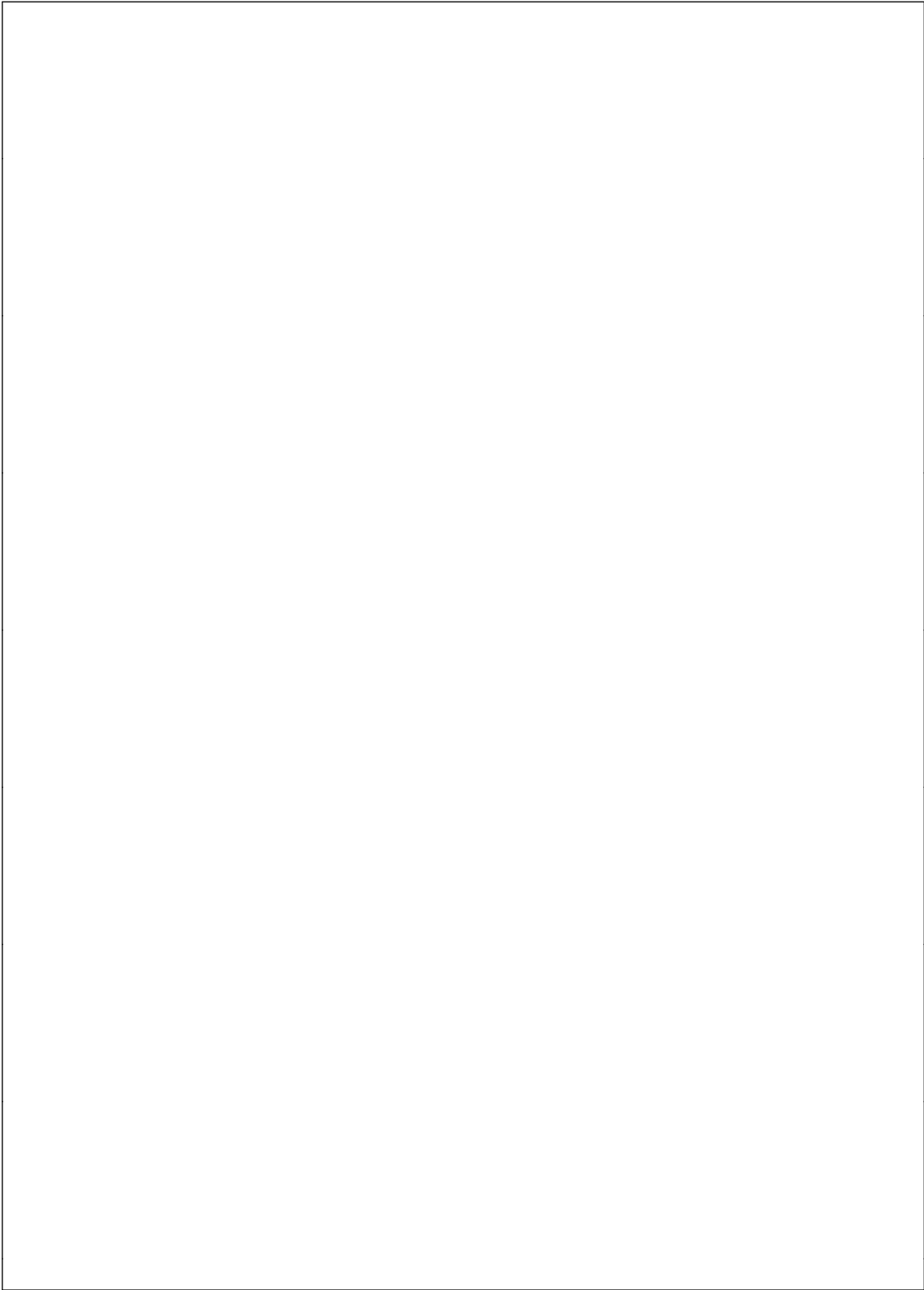

**Physical Dimensions** inches (millimeters)

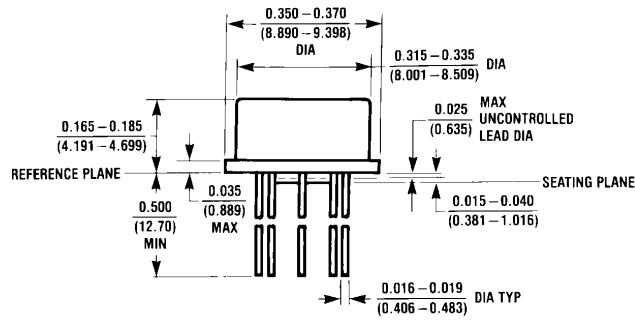

**Metal Can Package**  
 Order Number LM710AMH/883, LM710H, LM710H/883 or LM710CH  
 NS Package Number H08C

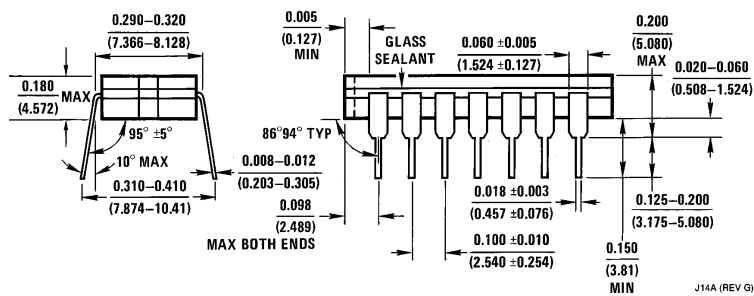
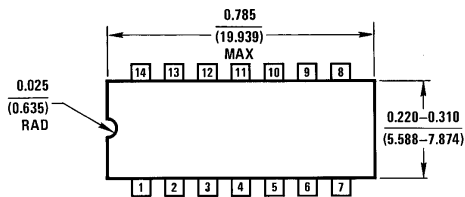

**Ceramic Dual-In-Line Package**  
 Order Number LM710AMJ/883  
 NS Package Number J14A

**Physical Dimensions** inches (millimeters) (Continued)

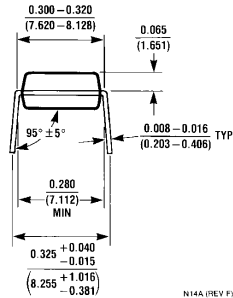
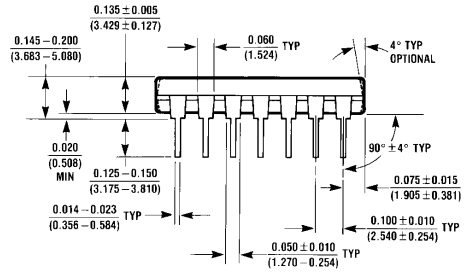
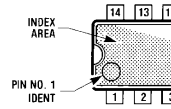
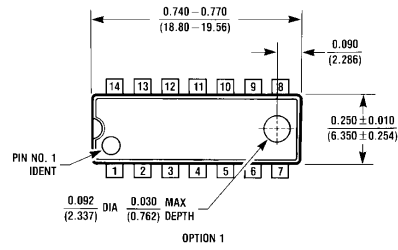

**Molded Dual-In-Line Package (N)**  
**Order Number LM710CN**  
**NS Package Number N14A**

N14A (REV F)

**Physical Dimensions** inches (millimeters) (Continued)

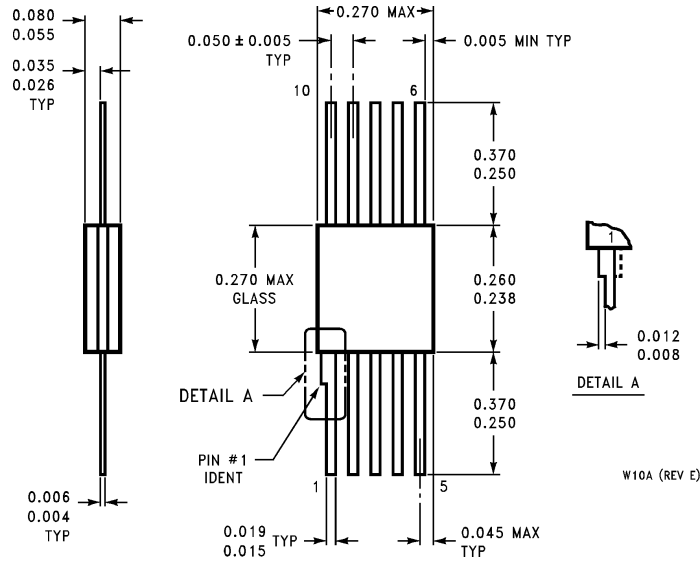

**Ceramic Flatpak**  
**Order Number LM710AMW/883**  
**NS Package Number W10A**

W10A (REV E)

**LIFE SUPPORT POLICY**

NATIONAL'S PRODUCTS ARE NOT AUTHORIZED FOR USE AS CRITICAL COMPONENTS IN LIFE SUPPORT DEVICES OR SYSTEMS WITHOUT THE EXPRESS WRITTEN APPROVAL OF THE PRESIDENT OF NATIONAL SEMICONDUCTOR CORPORATION. As used herein:

1. Life support devices or systems are devices or systems which, (a) are intended for surgical implant into the body, or (b) support or sustain life, and whose failure to perform, when properly used in accordance with instructions for use provided in the labeling, can be reasonably expected to result in a significant injury to the user.
2. A critical component is any component of a life support device or system whose failure to perform can be reasonably expected to cause the failure of the life support device or system, or to affect its safety or effectiveness.



**National Semiconductor Corporation**  
 1111 West Bardin Road  
 Arlington, TX 76017  
 Tel: 1(800) 272-9959  
 Fax: 1(800) 737-7018

**National Semiconductor Europe**  
 Fax: (+49) 0-180-530 85 86  
 Email: cnjwge@tevm2.nsc.com  
 Deutsch Tel: (+49) 0-180-530 85 85  
 English Tel: (+49) 0-180-532 78 32  
 Français Tel: (+49) 0-180-532 93 58  
 Italiano Tel: (+49) 0-180-534 16 80

**National Semiconductor Hong Kong Ltd.**  
 19th Floor, Straight Block,  
 Ocean Centre, 5 Canton Rd.  
 Tsimshatsui, Kowloon  
 Hong Kong  
 Tel: (852) 2737-1600  
 Fax: (852) 2736-9960

**National Semiconductor Japan Ltd.**  
 Tel: 81-043-299-2309  
 Fax: 81-043-299-2408

National does not assume any responsibility for use of any circuitry described, no circuit patent licenses are implied and National reserves the right at any time without notice to change said circuitry and specifications.