

SONOFF

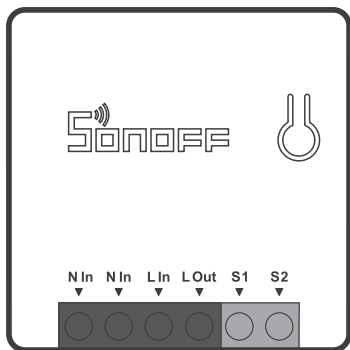

DIY MINIR2

User manual V1.1



Wi-Fi Smart Switch with DIY Mode

· 中文-----	1-5	· English-----	6-10
· Deutsch-----	11-15	· Español-----	16-20
· Français-----	21-25	· Italiano-----	26-30
· Русский язык-----	31-35	· Português-----	36-40
.....			
· FCC Warning-----	41		

使用说明

1. 断电

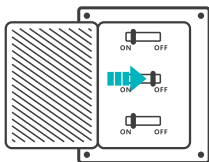

⚠ 设备安装、故障维修请由专业资质电工操作，以免发生触电危险！设备在正常使用的情况下不可触碰到。

2. 接线

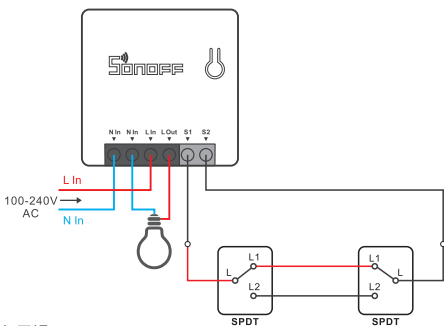

⚠ 确保零火线接入无误。

⚠ S1/S2接或不接机械开关两端，设备都可以正常使用。为确保安全，请勿接入零火线等强电。

3. 下载“易微联”APP

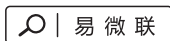

Android™ & iOS

4. 上电

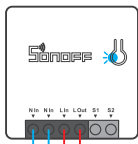

通电后, 设备首次使用, 默认进入快速配网模式(Touch)。Wi-Fi指示灯呈“两短一长闪烁”。

⊙ 三分钟内没有进行配网, 设备将退出快速模式。如需再次进入, 长按配对按钮5秒直到Wi-Fi指示灯呈两短一长闪烁即可。

5. 添加设备

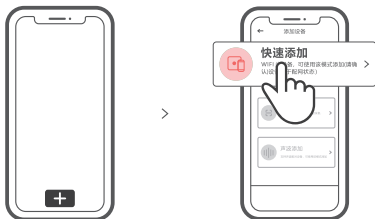

点击“+”, 选择“快速添加”, 再根据app提示进行操作。

兼容模式(AP)

如使用快速添加模式配网失败, 请使用“兼容模式(AP)”进行配对。

① 长按配对按钮5秒直到Wi-Fi指示灯呈“两短一长闪烁”状态, 松开。再次长按配对按钮5秒直到Wi-Fi指示灯呈“快闪”状态, 此时设备进入兼容模式。

② 在app界面, 点击“+”, 选择“兼容模式”。

先把移动设备连接上Wi-Fi账号为:ITEAD-*****, 密码为:12345678, 然后回到“易微联”app, 点击“下一步”, 等待配对完成。

产品参数

型号	MINIR2
最大输入	100-240V AC 50/60Hz 10A
最大输出	100-240V AC 50/60Hz 10A
支持平台	Android & iOS
Wi-Fi	IEEE 802.11 b/g/n 2.4GHz
材料	PC V0
产品规格	42.6x42.6x20mm

产品介绍

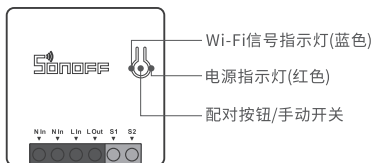

⚠ 设备重量 < 1Kg, 建议安装高度 < 2米。

Wi-Fi信号指示灯状态说明

指示灯状态	状态描述
两短一长闪烁	快速配网模式
快速闪烁	兼容模式(AP)
常亮	设备已连接
快闪一下	找不到路由
快闪二下	连接上路由, 但没连上外网
快闪三下	升级中

产品特点

用您的智能手机在任何地方打开或关闭家里的设备，设置定时开/关、分享给您的家人控制等等。



远程控制



智能定时/延时



语音控制



分享功能



智能场景



同步状态



无需交换机



添加摄像头



上电状态设置



局域网功能

更换设备网络

设备更换新的网络环境使用时，需长按设备配对按钮5秒直到Wi-Fi指示灯呈两短一长闪烁，松开，此时设备进入快速配网模式，即可再次添加。

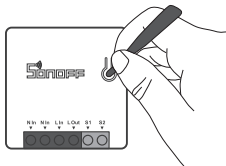

恢复出厂设置

在eWeLink app端“删除设备”，设备即恢复出厂设置。

常见问题

问：设备添加成功后，显示离线，无法控制？

答：设备刚添加成功后，需要1-2分钟时间连接您的路由器并连网。如果长时间还是显示不在线，请根据Wi-Fi指示灯的状态来判断：

1. 蓝灯2秒快闪一下：说明设备没有连上您的Wi-Fi。

- ① 可能是Wi-Fi密码输入不正确。
- ② 可能是设备离您的路由器太远，信号太弱，或环境有干扰。请先将设备靠近路由器，如无改善，重新添加一遍。
- ③ 设备不能识别5G的Wi-Fi，请选择2.4G的Wi-Fi重新添加。
- ④ 检查您的路由器后台是否开启MAC地址过滤，如有，请关闭。

如果以上均尝试不能解决，请用一部手机开启个人热点，尝试重新添加。

2. 蓝灯2秒快闪两下：说明设备已连接到了Wi-Fi 但没有连上外网。

请确认您的Wi-Fi当前连接外网是否稳定、正常。如时好时坏，频繁出现这种双闪情况，说明您的网络不稳定，并非产品原因。

Operating Instruction

1. Power off

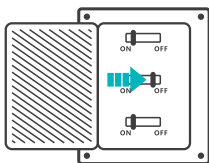

⚠ To avoid electric shocks, please consult the dealer or a qualified professional for help when installing and repairing! Please do not touch the switch during use.

2. Wiring instruction

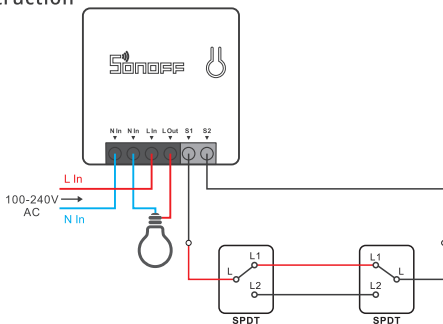

ⓘ Make sure the neutral wire and live wire connection is correct.

⚠ S1/S2 can connect with the rocker light switch or doesn't connect. To ensure safety, do not connect the neutral wire and live wire to it.

3. Download APP

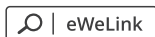

Android™ & iOS

4. Power on

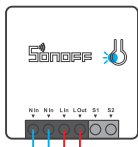

After powering on, the device will enter the quick pairing mode (Touch) during the first use. The Wi-Fi LED indicator changes in a cycle of two short and one long flash and release.

⚠ The device will exit the quick pairing mode (Touch) if not paired within 3mins. If you want to enter this mode, please long press the manual button for about 5s until the Wi-Fi LED indicator changes in a cycle of two short and one long flash and release.

5. Add the device

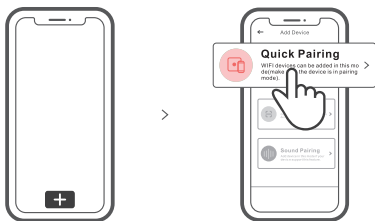

Tap "+" and select "Quick Pairing", then operate following the prompt on the APP.

Compatible Pairing Mode

If you fail to enter Quick Pairing Mode (Touch), please try "Compatible Pairing Mode" to pair.

- 1 Long press Pairing button for 5s until the Wi-Fi LED indicator changes in a cycle of two short flashes and one long flash and release. Long press Pairing button for 5s again until the Wi-Fi LED indicator flashes quickly. Then, the device enters Compatible Pairing Mode.
- 2 Tap "+" and select "Compatible Pairing Mode" on APP.

Select Wi-Fi SSID with ITEAD-***** and enter the password 12345678, and then go back to eWeLink APP and tap "Next". Be patient until pairing completes.

Specifications

Model	MINIR2
Input	100-240V AC 50/60Hz 10A Max
Output	100-240V AC 50/60Hz 10A Max
Operating systems	Android & iOS
Wi-Fi	IEEE 802.11 b/g/n 2.4GHz
Material	PC V0
Dimension	42.6x42.6x20mm

Product Introduction

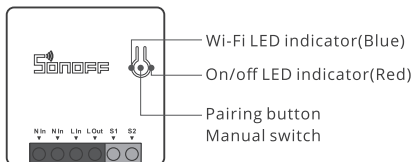

- ⚠ The device weight is less than 1 kg.
The installation height of less than 2 m is recommended.

Wi-Fi LED indicator status instruction

Wi-Fi LED indicator status	Status instruction
Flashes (one long and two short)	Quick Pairing Mode
Keeps on	Device is connected successfully
Flashes quickly	Compatible Pairing Mode
Flashes quickly once	Unable to discover the router
Flashes quickly twice	Connect to the router but fail to connect to Wi-Fi
Flashes quickly three times	Upgrading

Features

Turn on/off the device from anywhere, schedule power on/off and share APP with your family to control.



Remote Control

Single/Countdown
Timing

Voice Control



Share Control



Smart Scene



Sync Status



No Hub Required



Camera Linking



Power-on State



LAN Control

Switch Network

If you need to change the network, long press the pairing button for 5s until the Wi-Fi LED indicator changes in a cycle of two short and one long flash and release, then the device enters quick pairing mode and you can pair again.

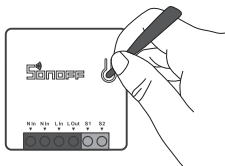

Factory Reset

Deleting the device on the eWeLink app indicates you restore it to factory setting.

Common Problems

Q: Why my device stays "Offline"?

A: The newly added device needs 1 – 2mins to connect Wi-Fi and network. If it stays offline for a long time, please judge these problems by the blue Wi-Fi indicator status:

1. The blue Wi-Fi indicator quickly flashes once per second, which means that the switch failed to connect your Wi-Fi:
 - ① Maybe you have entered a wrong Wi-Fi password.
 - ② Maybe there's too much distance between the switch your router or the environment causes interference, consider getting close to the router. If failed, please add it again.
 - ③ The 5G Wi-Fi network is not supported and only supports the 2.4GHz wireless network.
 - ④ Maybe the MAC address filtering is open. Please turn it off.

If none of the above methods solved the problem, you can open the mobile datanetwork on your phone to create a Wi-Fi hotspot, then add the device again.

2. Blue indicator quickly flashes twice per second, which means your device has connected to Wi-Fi but failed to connect to the server.

Ensure steady enough network. If double flash occurs frequently, which means you access an unsteady network, not a product problem. If the network is normal, try to turn off the power to restart the switch.

Betriebsanweisung

1. Ausschalten

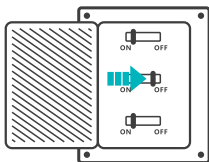

- ⚠ Wenden Sie sich bitte an den Händler oder einen qualifizierten Fachmann, um Hilfe bei der Installation und Reparatur zu erhalten und um Stromschläge zu vermeiden! Bitte berühren Sie den Schalter nicht während des Betriebs nicht.

2. Verkabelungsanleitung

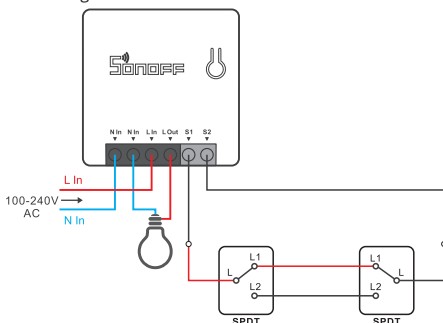

- ⓘ Vergewissern Sie sich, dass der Anschluss von Neutralleiter und stromführender Phase korrekt sind.
- ⚠ S1/S2 kann mit dem Wippenlichtschalter verbunden werden, muss aber nicht damit verbunden werden. Schließen Sie aus Sicherheitsgründen keine stromführende Phase und keinen Neutralleiter daran an.

3. APP herunterladen

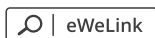

Android™ & iOS

4. Einschalten

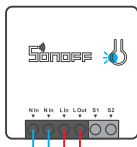

Nach dem Einschalten wechselt das Gerät bei der ersten Inbetriebnahme in den Schnellkopplungsmodus (Touch), Die WLAN-LED-Anzeige zu einem Intervall von „zweimaligem kurzen Blinken und einem langen Blinken wechselt“.

- ⓘ Das Gerät beendet den Schnellkopplungsmodus (Touch), wenn innerhalb von 3 Minuten keine Kopplung erfolgt. Wenn der Schnellkopplungsmodus erneut aufgerufen werden soll, drücken Sie bitte Konfigurationstaste 5 Sekunden, bis die WLAN-LED-Anzeige zu einem Intervall von zweimaligem kurzen Blinken und einem langen Blinken wechselt und lassen Sie erst dann die Taste los.

5. Gerät hinzufügen

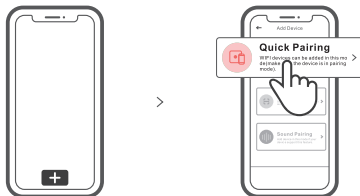

Tippen Sie auf „+“, wählen Sie „Schnellkopplung“ und arbeiten Sie dann gemäß der Aufforderung auf der APP.

Kompatibler Kopplungsmodus

Wenn Sie nicht in den Schnellkopplungsmodus (Touch) gelangen, versuchen Sie bitte den „Kompatibler Kopplungsmodus“ zum Koppeln.

- 1 Drücken Sie Konfigurationstaste für 5 Sekunden lang, bis sich die Wi-Fi-LED-Anzeige in einen Zyklus von zwei kurzen Blinken und einem langen Blinken und Freigabe ändert. Drücken Sie Konfigurationstaste erneut 5 Sekunden lang, bis die Wi-Fi-LED-Anzeige schnell blinkt. Dann geht das Gerät in den Kompatibler Kopplungsmodus über.
- 2 Tippen Sie auf „+“ und wählen Sie „Kompatibler Kopplungsmodus“ auf der APP. Wählen Sie Wi-Fi SSID mit ITEAD-***** und geben Sie das Passwort 12345678 ein, und gehen Sie dann zurück zu eWeLink APP und tippen Sie auf „Weiter“. Seien Sie geduldig, bis die Kopplung abgeschlossen ist.

Technische Daten

Modell	MINIR2
Eingang	100-240V AC 50/60Hz 10A Max
Ausgang	100-240V AC 50/60Hz 10A Max
Betriebssysteme	Android & iOS
WLAN	IEEE 802.11 b/g/n 2.4GHz
Materialien	PC V0
Abmessungen	42.6x42.6x20mm

Produktvorstellung

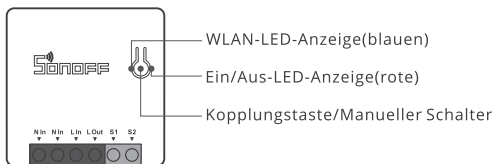

- ⚠ Das Gerätegewicht beträgt weniger als 1 kg.
Es wird eine Installationshöhe von weniger als 2 m empfohlen.

Wi-Fi LED-Anzeige Statusanzeige Anweisung

Wi-Fi LED-Anzeige Status	Status-Anweisung
Blinkt (einmal lang und zweimal kurz)	Schnellkopplungsmodus
Ist immer an	Gerät ist erfolgreich verbunden
Schnell blinkt	Kompatibler Kopplungsmodus
Blinkt einmal schnell	Der Router konnte nicht gefunden werden
Blinkt zweimal schnell	Erfolgreiche Verbindung zum Router, aber Wi-Fi ist nicht verbunden
Blinkt dreimal schnell	Aktualisierung

Merkmale

Schalten Sie das Licht von überall her ein/aus, planen Sie das Ein-/Ausschalten und teilen Sie App mit Ihrer Familie, damit alles von mehreren Personen gesteuert werden kann.



App Fernbedienug



Zeitpläne



Sprachsteuerung



Freigabesteuerung



Intelligente Szenarien



Synchronisationsstatus



Kein Hub erforderlich



Kamera hinzufügen



Einschaltstatus



LAN-Steuerung

Schalt-Netzwerk

Wenn Sie das Netzwerk wechseln müssen, drücken Sie die Paarungstaste 5s lang, bis die Wi-Fi-LED-Anzeige in einem Zyklus von zwei kurzen und einem langen Aufblitzen und Loslassen wechselt und das Gerät in den Schnellkopplungsmodus wechselt, Sie können dann erneut paaren.

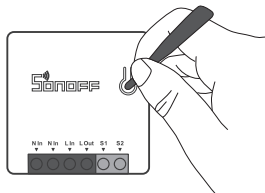

Zurücksetzen auf Werkseinstellungen

Wenn Sie das Gerät in der eWeLink-App löschen, wird es auf die Werkseinstellung zurückgesetzt.

Häufige Probleme

F: Warum bleibt mein Gerät „offline“?

A: Das neu hinzugefügte Gerät benötigt ca. 1 bis 2 Min., um die Verbindung zum WLAN und Netzwerk herzustellen. Wenn es längere Zeit offline bleibt, überprüfen Sie diese Probleme bitte anhand des Status der blauen WLAN-Anzeige:

1. Die blaue WLAN-Anzeige blinkt schnell einmal pro Sekunde, das bedeutet, dass der Schalter keine Verbindung mit dem WLAN herstellen konnte:
 - ① Vielleicht haben Sie ein falsches Passwort eingegeben.
 - ② Vielleicht ist der Abstand zwischen dem Schalter und dem Router zu groß oder es gibt Störungen in der Umgebung. Versuchen Sie, näher an den Router zu gelangen. Falls dies fehlschlägt, fügen Sie das Gerät bitte erneut hinzu.
 - ③ Ein 5G-WLAN-Netzwerk wird nicht unterstützt. Es wird nur ein kabelloses 2,4-GHz-Netzwerk unterstützt.
 - ④ Vielleicht ist die MAC-Adressfilterung geöffnet. Schalten Sie diese bitte aus.

Wenn das Problem durch keine der oben genannten Methoden behoben wurde, können Sie das mobile Datennetz auf Ihrem Handy öffnen, um einen WLAN-Hotspot aufzubauen, und das Gerät dann erneut hinzuzufügen.

2. Die blaue Anzeige blinkt schnell zweimal pro Sekunde, dies bedeutet, dass Ihr Gerät mit dem WLAN verbunden ist, aber keine Verbindung zum Server hergestellt wurde. Stellen Sie sicher, dass das Netzwerk stabil genug ist. Wenn häufiger einzweifaches Blinken auftritt, bedeutet dies, dass nur ein instabiles Netzwerk zur Verfügung steht. Dies stellt keinen Fehler des Produkts dar. Wenn der Netzwerkstatus normal ist, versuchen Sie, die Stromversorgung auszuschnalten, um den Schalter neu zu starten.

Instrucciones de funcionamiento

1. Apagado

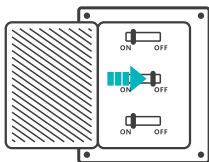

- ⚠ Para evitar descargas eléctricas, consulte con su distribuidor o un profesional cualificado para solicitar ayuda durante la instalación y la reparación! No toque el interruptor durante el uso.

2. Instrucciones de cableado

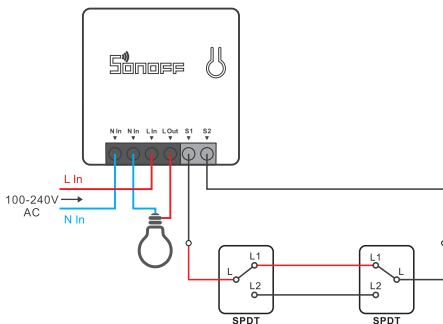

- ⓘ Compruebe que las conexiones del cable neutro y activo sean correctas.
- ⚠ Posible conectar S1/S2 con el interruptor de la luz o no conectarlo. Para garantizar la seguridad, no conecte el cable neutro y el activo al dispositivo.

3. Descargar la aplicación

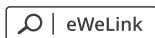

Android™ & iOS

4. Encender

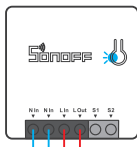

Después de encender, el dispositivo se pondrá en modo de emparejamiento rápido (Touch) durante el primer uso. El indicador LED de Wi-Fi cambiará a "un ciclo de dos parpadeos cortos y uno largo".

⚠ El dispositivo saldrá del modo de emparejamiento rápido (Touch) si no se ha emparejado al cabo de 3 minutos. Si necesita volver a ese modo, mantenga presionado botón de configuración 5 segundos hasta que el LED indicador de Wi-Fi cambie a un ciclo de dos parpadeos cortos y uno largo. A continuación, suelte el botón.

5. Añadir el dispositivo



Pulse "+" y seleccione "emparejamiento rápido", luego opere siguiendo las indicaciones de la aplicación.

Modo de emparejamiento compatible

Si no puede entrar al modo de emparejamiento rápido, por favor intente con "Modo de emparejamiento compatible" para emparejar.

- 1 Presione de manera sostenida botón de configuración durante 5 segundos hasta que el indicador LED del Wi-Fi cambie en un ciclo de dos parpadeos cortos y uno largo y suelte. Presione de manera sostenida botón de configuración durante 5 segundos nuevamente hasta que el indicador LED del Wi-Fi parpadee rápidamente. Luego, el dispositivo entra en modo de emparejamiento Compatible.
- 2 Presione "+" y seleccione "modo de emparejamiento compatible" en la aplicación. Seleccione el SSID del Wi-Fi con ITEAD-***** e ingrese la contraseña 12345678, luego regrese a la aplicación eWeLink y presione "Siguiente" Sea paciente mientras se complete el emparejamiento.

Especificaciones

Modelo	MINIR2
Entrada	100-240V CA 50/60Hz 10A máx.
Salida	100-240V CA 50/60Hz 10A máx.
Sistemas operativos	Android & iOS
Wi-Fi	IEEE 802.11 b/g/n 2.4GHz
Materiale	PC V0
Dimensiones	42.6x42.6x20mm

Introducción al producto

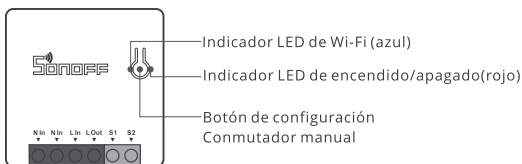

- ⓘ El peso del dispositivo es inferior a 1 kg.
Se recomienda una altura de instalación inferior a 2 m.

Instrucciones del indicador de estado Wi-Fi LED

Wi-Fi Indicador de Estado LED	Instrucción de estado
Parpadea (uno largo y dos cortos)	Modo de emparejamiento rápido
Siempre está encendida	El dispositivo está conectado correctamente
Parpadea rápidamente	Modo de emparejamiento compatible
Parpadea rápidamente una sola vez	Incapaz de encontrar el router
Parpadea rápidamente dos veces	Conectado al router correctamente pero el Wi-Fi no está conectado
Parpadea rápidamente tres veces	Actualización

Características

Apague la luz desde cualquier parte, programe el encendido/apagado y comparta la aplicación con su familia para controlarlo.



Control remoto desde plicación



Programas



Control por voz



Control compartido



Escenas



Estado de sincronización



No necesita hub



Agregar cámara



Indicador de encendido



Control vía

Cambiar Red

Si necesitas cambiar la red, presiona sin soltar el botón de emparejamiento por 5 segundos hasta que el indicador de Wi-Fi LED cambie a un ciclo de dos parpadeos cortos y un parpadeo largo para luego soltar, y luego de que dispositivo entre en el modo de emparejamiento rápido, podrás emparejarlo de nuevo.

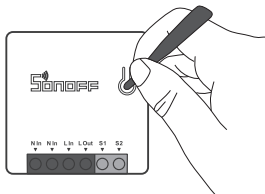

Restablecimiento de los ajustes de fábrica

Si borras el dispositivo en la aplicación eWeLink se restaurará a valores de fábrica.

Problemas frecuentes

P: ¿Por qué el dispositivo permanece “Sin conexión”?

A: El dispositivo recién añadido necesita de 1 a 2 minutos para conectarse a Wi-Fi y a la red. Si permanece sin conexión durante mucho tiempo, evalúe la situación con el estado del indicador azul de Wi-Fi.

1. El indicador azul de Wi-Fi parpadea rápidamente una vez por segundo, lo cual significa que el interruptor no se ha podido conectar a la red Wi-Fi:

- ① Es posible que haya introducido una contraseña de Wi-Fi incorrecta.
- ② Es posible que la distancia entre el interruptor y el router sea demasiado grande o que el entorno provoque interferencias. Piense en acercarlos entre sí. Si falla, vuelva a añadirlo.
- ③ La red 5G Wi-Fi no es compatible y solo admite la red inalámbrica de 2,4 GHz.
- ④ Es posible que el filtrado de direcciones MAC esté activado. Desactívelo.

Si no ha sido posible solucionar el problema mediante ninguno de los métodos anteriores, puede abrir la red de datos móviles del teléfono para crear un punto de acceso Wi-Fi y, a continuación, volver a añadir el dispositivo.

2. El indicador azul parpadea rápidamente dos veces por segundo, lo cual significa que el dispositivo se ha conectado a Wi-Fi pero no se ha podido conectar al servidor.

Asegúrese de que la red sea estable. Si el doble parpadeo ocurre con frecuencia, esto significa que se accede a una red poco estable, no es un problema del producto. Si la red es normal, intente apagar la alimentación para reiniciar el interruptor.

Instruction d'opération

1. Éteindre

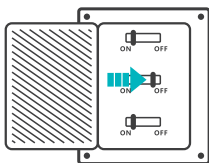

⚠ Pour éviter les électrocutions, prenez contact avec le revendeur ou un professionnel qualifié pour obtenir de l'aide pour l'installation et les réparations éventuelles! Veuillez ne pas toucher l'interrupteur pendant l'utilisation.

2. Instructions de câblage

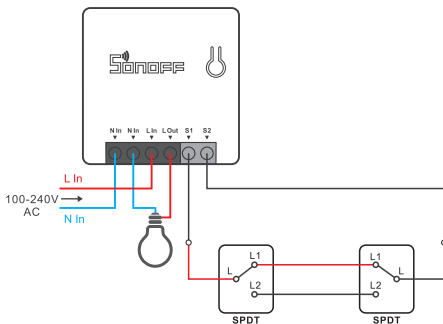

ⓘ Assurez-vous que le fil neutre et le fil sous tension sont correctement installés.

⚠ S1/S2 peuvent se connecter au commutateur d'éclairage ou ne se connectent pas. Afin d'assurer la sécurité, ne pas lui connecter les fils de neutre et de phase.

3. Télécharger l'application

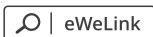

Android™ & iOS

4. Allumer

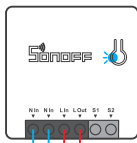

Après allumage, l'appareil entre en mode d'association rapide (Touch) lors de l'utilisation initiale, Que l'indicateur DEL Wi-Fi clignote « deux fois rapidement puis une fois rapidement ».

⚠ L'appareil quitte le mode de jumelage rapide (Touch) s'il n'est pas jumelé dans les 3 minutes. Pour y revenir, appuyer longuement sur quell bouton de configuration 5 secondes jusqu'à ce que l'indicateur à DEL du Wi-Fi effectue un cycle de deux éclats courts et un éclat long puis relâcher.

5. Ajouter l'appareil



Tapez sur « + » et sélectionnez « Appairage rapide », puis suivez l'invite sur l'application.

Mode d'appairage compatible

Si vous ne parvenez pas à entrer en mode d'appairage rapide (Touch), veuillez essayer le « Mode d'appairage compatible » pour effectuer l'appairage.

- 1 Appuyez longuement sur le bouton de configuration pendant 5s jusqu'à ce que l'indicateur DEL Wi-Fi change en un cycle de deux clignotements courts et un clignotement long, puis relâchez. Appuyez longuement sur le bouton de configuration de pendant 5 secondes jusqu'à ce que le voyant DEL Wi-Fi clignote rapidement. Ensuite, l'appareil entre en mode d'appairage compatible.
- 2 Appuyez sur « + » et sélectionnez « Mode d'appairage compatible » sur l'APP.
Sélectionner Wi-Fi SSID avec ITEAD-***** et entrer le mot de passe 12345678, puis retourner à l'APP eWeLink et appuyer sur « Suivant ». Soyez patient jusqu'à ce que l'appairage soit terminé.

Caractéristiques techniques

Modèle	MINIR2
Entrée	100-240V CA 50/60Hz 10A Max
Sortie	100-240V CA 50/60Hz 10A Max
Systèmes d'exploitation	Android & iOS
Wi-Fi	IEEE 802.11 b/g/n 2.4GHz
Matériel	PC V0
Dimensions	42.6x42.6x20mm

Présentation du produit

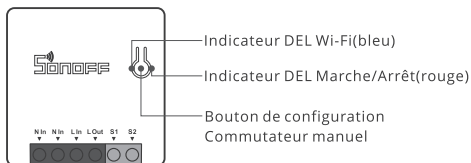

- ⚠ Le poids du dispositif est inférieur à 1 kg.
Il est recommandé d'installer le dispositif à une hauteur inférieure à 2 m.

Wi-Fi Instruction d'état du voyant

Statut de l'indicateur Wi-Fi LED	Instruction d'état
Clignote (une longue et deux courtes)	Mode de couplage rapide
Est toujours allumé	L'appareil est connecté avec succès
Clignote rapidement	Mode d'appairage compatible
Clignote rapidement une fois	Impossible de trouver le routeur
Clignote rapidement deux fois	Connexion réussie au routeur, mais le Wi-Fi n'est pas connecté.
Clignote rapidement trois fois	Mise à jour

Caractéristiques

Permet d'allumer/éteindre une lampe de n'importe où, de planifier l'allumage/la mise hors tension et de partager le contrôle avec votre famille avec l'appli.



Appli
télécommande



Planification



Contrôle vocal



Contrôle partagé



Scènes
intelligentes



État de
synchronisation



Pas de hub
requis



Ajouter une
caméra



État de mise sous
tension



Contrôle via
LAN

Réseau de commutation

Si vous devez changer de réseau, appuyez longtemps sur le bouton d'appairage pendant 5s jusqu'à ce que le voyant lumineux Wi-Fi change en un cycle de deux clignotements courts et un clignotement long, puis relâchez et l'appareil passe en mode de couplage rapide, puis vous pouvez à nouveau vous appairer.

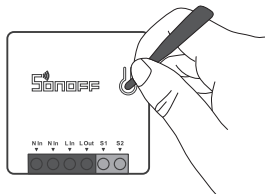

Rétablissement des paramètres d'usine

La suppression de l'appareil sur l'application eWeLink indique que vous le restaurez aux réglages d'usine.

Problèmes courants

Q : Pourquoi mon appareil reste-t-il « Hors ligne » ?

A: Un appareil que vous venez d'ajouter requiert 1 à 2 minutes pour se connecter au Wi-Fi et au réseau. S'il reste hors ligne pendant une durée prolongée, voyez les informations données par l'indicateur Wi-Fi :

1. L'indicateur Wi-Fi bleu clignote brièvement une fois par seconde. Cela indique que l'interrupteur ne réussit pas à se connecter à votre Wi-Fi.
 - ① Il se peut que vous ayez saisi un mot de passe Wi-Fi incorrect.
 - ② Peut-être que votre interrupteur est trop éloigné de votre router ou que votre environnement contient des interférences. Rapprochez l'interrupteur du router si possible. En cas d'échec, ajoutez-le de nouveau.
 - ③ La fréquence Wi-Fi 5G n'est pas prise en charge. Seule la fréquence 2.4 GHz peut être utilisée.
 - ④ Le filtrage d'adresse MAC est peut-être activé. Désactivez le filtrage MAC.

Si aucune des méthodes ci-dessus n'a résolu le problème, vous pouvez ouvrir le réseau de données mobile sur votre téléphone pour créer un point d'accès sans fil Wi-Fi, puis ensuite ajouter à nouveau l'appareil.

2. L'indicateur bleu clignote rapidement deux fois par seconde, ce qui indique que l'interrupteur est connecté au Wi-Fi mais n'arrive pas à se connecter au serveur. Vérifiez que le réseau fonctionne correctement. Si l'indicateur clignote deux fois rapidement, cela indique que votre réseau est instable, pas que le dispositif est en panne. Si votre réseau est normal, essayez d'éteindre l'appareil et le redémarrer.

Istruzioni per l'uso

1. Spegnimento

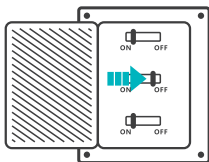

- ⚠ Per evitare scosse elettriche, consultare il rivenditore o un professionista qualificato per assistenza durante l'installazione e la riparazione!
Non toccare l'interruttore durante l'uso.

2. Istruzioni per il cablaggio

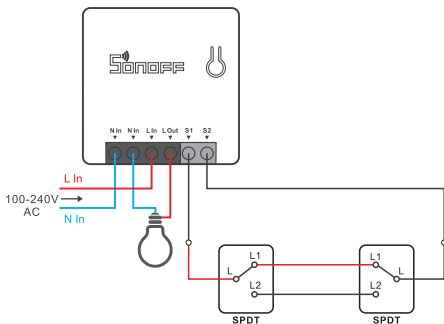

- ⚠ Assicurarsi che il collegamento del cavo di neutro e del cavo di fase sia corretto.
⚠ S1/S2 può essere collegato con l'interruttore della luce a bilanciere o non si collega. Per garantire la sicurezza, non collegarvi il cavo neutro e il cavo sotto tensione.

3. Scarica la APP

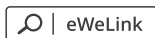

Android™ & iOS

4. Accensione

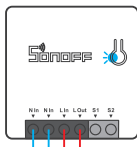

Dopo l'accensione, il dispositivo entrerà nella modalità di accoppiamento (Touch) durante il primo utilizzo, l'indicatore LED del Wi-Fi passa a "un ciclo di due lampeggi brevi e uno lungo".

⚠ Il dispositivo uscirà dalla modalità di abbinamento rapido (Touch) se non abbinato entro 3 minuti. Se avete necessità di effettuare nuovamente l'accesso, premere a lungo pulsante di configurazione 5 sec fino a quando la spia LED del Wi-Fi lampeggia ciclicamente due volte velocemente ed una volta a lungo, quindi rilasciare.

5. Aggiungere il dispositivo

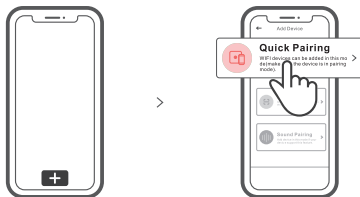

Toccare "+" e selezionare "Accoppiamento rapido", quindi procedere seguendo le indicazioni dell'APP.

Modalità di accoppiamento compatibile

Se non è possibile accedere alla Modalità di accoppiamento rapido (Touch), provare con la "Modalità di accoppiamento compatibile" per eseguire l'accoppiamento.

- 1 Premere a lungo tasto di configurazione per 5 sec. fino a quando l'indicatore LED Wi-Fi inizia a lampeggiare con un ciclo di due lampeggi brevi e un lampeggio lungo e quindi rilasciarlo. Premere di nuovo a lungo tasto di configurazione per 5 sec. fino a quando l'indicatore LED Wi-Fi lampeggia rapidamente. A questo punto, il dispositivo entra in Modalità di accoppiamento compatibile.
- 2 Toccare "+" e selezionare "Modalità di accoppiamento compatibile" sull'APP. Selezionare l'SSID Wi-Fi con ITEAD-***** e inserire la password 12345678, quindi tornare indietro all'APP eWeLink e toccare "Avanti". Pazientare fino al completamento dell'accoppiamento.

Specifiche

Modello	MINIR2
Ingresso	100-240V AC 50/60Hz 10A Max
Uscita	100-240V AC 50/60Hz 10A Max
Sistemi operativi	Android & iOS
Wi-Fi	IEEE 802.11 b/g/n 2.4GHz
Materiale	PC V0
Dimensioni	42.6x42.6x20mm

Introduzione al prodotto

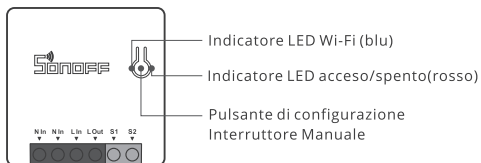

- ⚠ Il peso del dispositivo è inferiore a 1 kg.
Si raccomanda un'altezza di installazione inferiore a 2 m.

Istruzioni sullo stato dell'indicatore Wi-Fi LED

Stato dell'indicatore Wi-Fi LED	Istruzioni sullo stato
Il LED blu un ciclo di due lampeggi brevi e uno lungo	Modalità di accoppiamento rapido
Il LED blu costantemente accesa	Il collegamento del dispositivo è stato eseguito correttamente
Il LED blu che lampeggia rapidamente	Modalità di accoppiamento compatibile
Il LED blu che lampeggia rapidamente una volta sola	Impossibile trovare il router
Il LED blu che lampeggia rapidamente per due volte	Il collegamento con il router è stato eseguito correttamente ma il Wi-Fi non è connesso.
Il LED blu che lampeggia rapidamente per tre volte	Aggiornamento

Caratteristiche

Accendi/spegni la luce da qualsiasi luogo, programma l'accensione/spegnimento e condividi l'APP con la tua famiglia per controllarla.



Telecomando
via APP



Programmazione



Controllo vocale



Controllo della
condivisione



Scene intelligenti



Stato della
sincronizzazione



Nessun hub
necessario



Aggiungere
fotocamera



Stato di accensione



Controllo LAN

Rete di commutazione

Se è necessario commutare la rete, premere a lungo il pulsante di accoppiamento per 5s fino a quando l'indicatore LED Wi-Fi inizia a lampeggiare ciclicamente con 2 brevi accensioni e una più lunga e quindi si spegne. Il dispositivo entra in modalità di accoppiamento rapido; a questo punto è possibile eseguire di nuovo l'associazione.

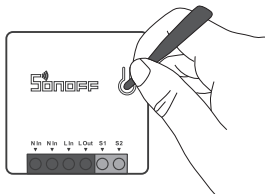

Ripristino impostazioni di fabbrica

La cancellazione del dispositivo sull'applicazione eWeLink indica il ripristino delle impostazioni di fabbrica.

Problemi comuni

D: Perché il mio dispositivo rimane "Offline"?

R: Il dispositivo appena aggiunto ha bisogno di 1 - 2 minuti per connettersi al Wi-Fi e alla rete. Se rimane offline per un lungo periodo, individuare il problema in base allo stato dell'indicatore Wi-Fi blu:

1. L'indicatore blu Wi-Fi lampeggia velocemente una volta al secondo, il che significa che l'interruttore non è riuscito a connettersi al Wi-Fi:

- ① Forse è stata inserita una password del Wi-Fi sbagliata.
- ② Forse c'è troppa distanza tra l'interruttore e il proprio router o l'ambiente causa interferenze, provare ad avvicinare il router. Se non funziona, effettuare nuovamente l'operazione di accoppiamento.
- ③ La rete Wi-Fi 5G non è supportata, mentre è supportata solo la rete wireless a 2,4 GHz.
- ④ Forse il filtro degli indirizzi MAC è aperto. Nel caso, disattivarlo.

Se nessuno dei suggerimenti di cui sopra ha risolto il problema, è possibile aprire la rete dati mobile sul telefono per creare un hotspot Wi-Fi, quindi aggiungere nuovamente il dispositivo.

2. L'indicatore blu lampeggia velocemente due volte al secondo, il che significa che il dispositivo è connesso al Wi-Fi ma non è riuscito a connettersi al server.

Verificare che la rete sia sufficientemente stabile. Se il doppio lampeggio si verifica frequentemente, significa che si cerca di accedere a una rete instabile e non si tratta di un problema del prodotto. Se la rete è normale, provare a spegnere il dispositivo per riavviare l'interruttore.

Инструкция по эксплуатации

1. Выключить

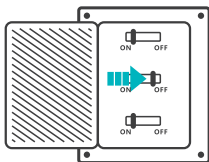

⚠ Во избежание поражения электрическим током при установке и ремонте обращайтесь за консультациями к продавцу или квалифицированному специалисту! Не касайтесь переключателя во время использования.

2. Инструкции по проводке

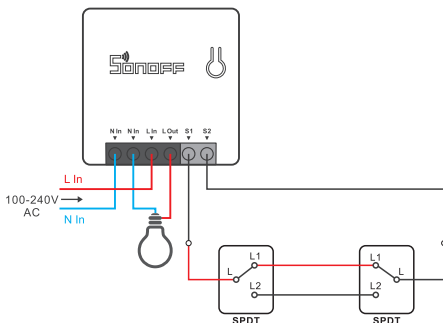

ⓘ Убедитесь, что провод нейтрали (ноль) и провод под напряжением (фаза) подключены.

⚠ Возможно подключение S1/S2 с помощью переключателя-тумблера. В целях безопасности не подключайте к нему провод нейтрали и провод фазы.

3. Скачать приложение

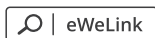

Android™ & iOS

4. Включить

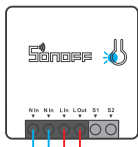

После первого включения устройство перейдет в режим быстрого сопряжения. светодиодный индикатор Wi-Fi начнет мигать в режиме «два раза коротко, один раз длинно».

⚠ Устройство выйдет из режима быстрого сопряжения (Touch), если сопряжение не будет выполнено в течение 3 минут. Если нужно войти снова, нажмите и удерживайте кнопку конфигурации 5 секунд, пока индикатор Wi-Fi не изменится по очереди на два коротких и одно длинное мигание, затем отпустите.

5. Добавить устройство

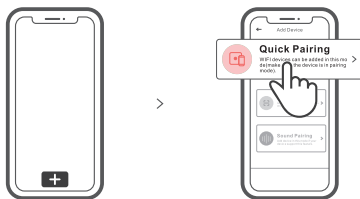

Коснитесь «+» и выберите «Быстрое связывание», затем выполняйте действия после появления подсказки в приложении.

Режим совместимого соединения

Если вход в режим быстрого связывания устройств (касание) выполнить не удалось, для установки связи попробуйте «Режим совместимого соединения».

① Выполняйте долгое нажатие кнопки настройки на протяжении 5 с, пока не начнет мигать светодиодный индикатор Wi-Fi — цикл работы индикатора выглядит как две короткие вспышки и одна длинная. Затем отпустите кнопку. Выполняйте долгое нажатие кнопки настройки на протяжении 5 с, пока светодиодный индикатор Wi-Fi не начнет быстро мигать. Затем устройство переходит в режим совместимого соединения .

② Коснитесь «+» и выберите «Режим совместимого соединения» в приложении.

Выберите SSID Wi-Fi в ITEAD-***** и введите пароль 12345678, затем вернитесь в приложение eWeLink и коснитесь «Далее». Подождите некоторое время, пока не завершится установка соединения.

Технические характеристики

Модель	MINIR2
Входная мощность	100-240В пер. тока 50/60Гц 10А макс.
Выходная мощность	100-240В пер. тока 50/60Гц 10А макс.
Операционные системы	Android & iOS
Wi-Fi	IEEE 802.11 b/g/n 2.4GHz
Материал	PC V0
Размеры	42.6x42.6x20 мм

Знакомство с изделием

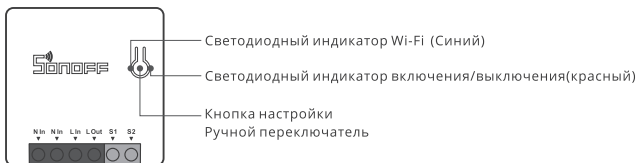

- ⚠ Вес устройства составляет менее 1 kg.
Рекомендуется устанавливать устройство на высоте менее 2 м.

Инструкция режима светодиодного индикатора

Режим светодиодного индикатора	Описание режима
Мигает голубой светодиодная лампочка (один длинный и два коротких)	Режим быстрого сопряжения
светодиодная синего цвета всегда горит	Устройство успешно подключено
светодиодная синего цвета быстро мигает	Режим совместимого соединения
светодиодная синего цвета быстро мигает один раз	Невозможно найти роутер
светодиодная синего цвета быстро мигает два раза	Успешное подключение к маршрутизатору, но Wi-Fi не подключен
светодиодная синего цвета быстро мигает три раза	Обновление

Функции

Включайте/выключайте освещение откуда угодно, составляйте расписание включения/выключения питания и предоставляйте доступ к приложению близким для управления им.



Управ. прилож.



Расписания



Управл. голосом



Доступ д/управл.



Смарт-сюжеты



Статус синхр.



Конц. не нужен



Добавить камеру



Режим включения



Управл. пров. сетью

Переключить сеть

Если Вам необходимо переключить сеть, удерживайте кнопку сопряжения в течение 5 с. Когда светодиодный индикатор Wi-Fi изменится на цикл из двух коротких и одного длинного мигания, отпустите. Устройство перейдет в режим быстрого сопряжения, после чего Вы можете снова выполнить сопряжение.

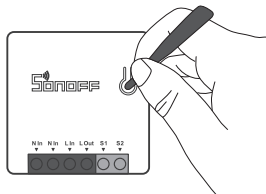

Сброс до заводских настроек

Удаление устройства в приложении eWeLink означает, что Вы восстанавливаете его до заводских настроек.

Стандартные проблемы

В: Почему устройство не подключается к сети?

О: Для подключения нового устройства к сети Wi-Fi и Интернету требуется 1-2 минуты. Если устройство не подключается к сети дольше, определить причину проблемы можно по статусу синего индикатора Wi-Fi. Возможные варианты:

1. Синий индикатор Wi-Fi быстро мигает раз в секунду, что означает, что коммутатору не удалось подключиться к вашей сети Wi-Fi:
 - ① Возможно, вы неправильно ввели пароль от сети Wi-Fi.
 - ② Возможно, расстояние между коммутатором и вашим роутером слишком велико либо окружение создает помехи. Попробуйте приблизить коммутатор к роутеру.
 - ③ Сеть Wi-Fi 5G не поддерживается, устройство поддерживает только беспроводную сеть 2,4 ГГц.
 - ④ Возможно, открыта фильтрация MAC-адреса. Отключите ее.

Если ни один из перечисленных методов не устранил проблему, можно включить мобильную сеть для передачи данных на телефоне и создать точку доступа Wi-Fi, после чего снова добавить устройство.

2. Синий индикатор быстро мигает два раза в секунду, что означает, что устройство подключено к сети Wi-Fi, но не подключилось к серверу.

Убедитесь, что ваша сеть работает стабильно. Если ситуация с двойным быстрым миганием возникает часто, это указывает на нестабильную сеть, а не на неполадки в работе изделия. Если сеть работает нормально, попробуйте выключите и перезапустите коммутатор.

Instrução de Operação

1. Desligar

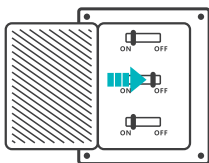

⚠ Para evitar choques elétricos, por favor consulte o seu distribuidor ou um profissional qualificado para auxiliar na instalação e reparo. Por favor não toque no painel durante o uso.

2. Instruções de instalação

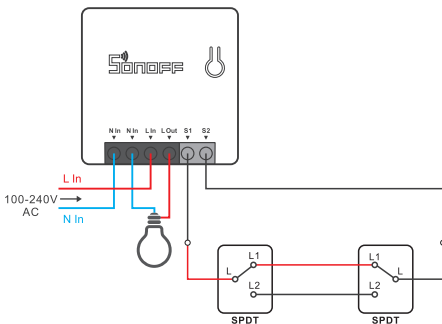

⊗ Certifique-se de que os cabos neutro e fase estejam conectados corretamente.

⚠ É possível conectar S1/S2 com o interruptor de luz ou não o conectar. Para garantir a segurança, não conecte o cabo neutro e fase ao dispositivo.

3. Baixe o APP

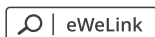

Android™ & iOS

4. Ligue

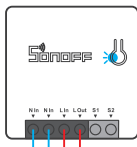

Após ligar o aparelho entrará em modo de pareamento (Touch) durante o primeiro uso. O indicador LED Wi-Fi mudará para um ciclo de dois flashes curtos e um longo.

⚠ O aparelho irá sair do modo de pareamento se a conexão com o Wi-Fi não for feita em até 3 minutos. Se você queira entrar nesse modo, por favor pressione Botão de emparelhamento 5 s até que o indicador LED do Wi-Fi mude para um círculo de dois flashes curtos e um longo em seguida solte.

5. Adicione o aparelho

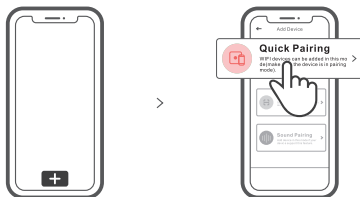

Toque “+” e selecione “Quick Pairing” então prossiga seguindo as instruções do aplicativo.

Modo de pareamento compatível

Caso falhar ao entrar no modo de pareamento rápido (Touch), por favor tente o “modo de pareamento compatível” para parear.

- 1 Pressione botão de configuração por 5 segundos até o indicador LED Wi-Fi mudar para um ciclo de dois flashes curtos e um longo e solte. Pressione botão de configuração por 5 segundos novamente até o indicador LED Wi-Fi pisque rapidamente. Então o dispositivo entrará em modo de pareamento compatível.
- 2 Toque “+” e selecione “Modo de pareamento compatível” no aplicativo.
Conecte o dispositivo móvel à conta Wi-Fi: ITEAD - ***** e a senha:12345678, então volte ao aplicativo eWeLink e clique em “Próximo”. Espere até que o pareamento esteja completo.

Parâmetros do produto

Modelo	MINIR2
Entrada	100-240V AC 50/60Hz 10A Max
Saída	100-240V AC 50/60Hz 10A Max
Sistemas operacionais	Android & iOS
Wi-Fi	IEEE 802.11 b/g/n 2.4GHz
Material de revestimento	PC
Dimensão	42.6x42.6x20 mm

Introdução ao produto

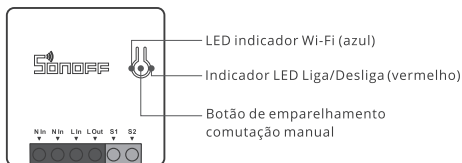

- ⓘ O peso do dispositivo é inferior a 1 kg.
Recomenda-se uma altura de instalação inferior a 2 m.

Instruções do status do indicador LED Wi-Fi

Status do indicador LED	Descrição de status
LED azul Piscando (um flash longo e dois curtos)	Modo de pareamento rápido
LED azul acesa	O dispositivo foi conectado com sucesso
LED azul pisque rapidamente	Modo de pareamento compatível
LED azul pisca rapidamente uma vez	Não foi possível encontrar o roteador
LED azul pisca rapidamente duas vezes	Conectou-se ao roteador, mas falhou ao se conectar ao wi-fi
LED azul pisca três vezes rapidamente	Atualizando

Funções

Liga/Desliga luz de qualquer lugar, programa quando liga/desliga e compartilhe o controle com a sua família



Controle pelo aplicativo



Programador de tempo



Controle por voz



Compartilhar controle



Cenas inteligentes



Status de sincronização



Não requer ponte de ligação



Características da câmera



Estado de inicialização



Controle LAN

Mudar rede

Se você precisar alterar a rede, pressione e segure o botão de emparelhamento por 5s até que o indicador LED Wi-Fi mude em um ciclo de duas piscadas curtas e uma longa e solte, então o dispositivo entra no modo de emparelhamento rápido e você pode emparelhar novamente.

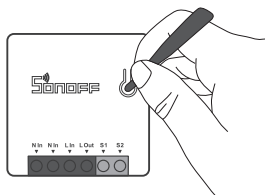

Redefinição de fábrica

Excluir o dispositivo no aplicativo eWeLink indica que você o restaurou para a configuração defábrica.

Problemas comuns

Q: Por que o dispositivo fica "OFFLINE"?

R: O novo dispositivo adicionado precisa de 1-2 minutos para se conectar ao roteador e Wi-Fi. Se continuar offline por um longo tempo, por favor verifique o problema pelo indicador Wi-Fi azul:

1. O indicador Wi-Fi azul pisca uma vez por segundo: significa que o dispositivo falhou ao se conectar ao seu Wi-fi
 - ① Talvez tenha sido inserida a senha incorreta.
 - ② Talvez o seu dispositivo esteja muito longe do seu roteador ou há algo causando interferências, considere aproximar-se do roteador. Se falhar, por favor adicione novamente.
 - ③ O dispositivo não suporta Wi-Fi 5G, somente rede 2.4GHz.
 - ④ Talvez o filtro do endereço MAC esteja ativado. Por favor o desative.

Se nenhum dos métodos acima resolveu o problema, você pode através do seu celular criar um ponto de Wi-Fi e adicione o dispositivo novamente.

2. Indicador azul pisca duas vezes por segundo: significa que o dispositivo se conectou ao Wi-Fi, mas falhou em se conectar ao servidor.

Certifique-se de que a sua rede esteja estável. Se o indicador piscar duas vezes com frequência significa que sua rede está instável e não é um problema do produto. Se a internet está normal, tente desligar da energia e reinicie o dispositivo.

Este equipamento não tem direito à proteção contra interferência prejudicial e não pode causar interferência em sistemas devidamente autorizados.

FCC Warning

Changes or modifications not expressly approved by the party responsible for compliance could avoid the user's authority to operate the equipment.

This device complies with part 15 of the FCC Rules. Operation is subject to the following two conditions: (1) This device may not cause harmful interference, and (2) this device must accept any interference received, including interference that may cause undesired operation.

FCC Radiation Exposure Statement:

This equipment complies with FCC radiation exposure limits set forth for an uncontrolled environment. This equipment should be installed and operated with minimum distance 20cm between the radiator & your body. This transmitter must not be co-located or operating in conjunction with any other antenna or transmitter.

Note:

This equipment has been tested and found to comply with the limits for a Class B digital device, pursuant to part 15 of the FCC Rules. These limits are designed to provide reasonable protection against harmful interference in a residential installation. This equipment generates, uses and can radiate radio frequency energy and, if not installed and used in accordance with the instructions, may cause harmful interference to radio communications. However, there is no guarantee that interference will not occur in a particular installation. If this equipment does cause harmful interference to radio or television reception, which can be determined by turning the equipment off and on, the user is encouraged to try to correct the interference by one or more of the following measures:

- Reorient or relocate the receiving antenna.
- Increase the separation between the equipment and receiver.
- Connect the equipment into an outlet on a circuit different from that to which the receiver is connected.
- Consult the dealer or an experienced radio/TV technician for help.

Hereby, Shenzhen Sonoff Technologies Co., Ltd. declares that the radio equipment type MINIR2 is in compliance with Directive 2014/53/EU. The full text of the EU declaration of conformity is available at the following internet address:

<https://sonoff.tech/usermanuals>

TX Frequency:

WiFi: 2412-2472MHz

RX Frequency:

WiFi: 2412-2472MHz

Output Power:

9.86dBm(802.11b), 9.93dBm(802.11g), 9.92dBm(802.11n20)



Shenzhen Sonoff Technologies Co., Ltd.

1001, BLDG8, Lianhua Industrial Park, shenzhen, GD, China
ZIP code: 518000 Website: sonoff.tech

MADE IN CHINA

