

# MJE13005G

## SWITCHMODE™ Series NPN Silicon Power Transistors

These devices are designed for high-voltage, high-speed power switching inductive circuits where fall time is critical. They are particularly suited for 115 and 220 V SWITCHMODE applications such as Switching Regulator's, Inverters, Motor Controls, Solenoid/Relay drivers and Deflection circuits.

### Features

- $V_{CEO(sus)}$  400 V
- Reverse Bias SOA with Inductive Loads @  $T_C = 100^\circ\text{C}$
- Inductive Switching Matrix 2 to 4 A, 25 and  $100^\circ\text{C}$   $t_c$  @ 3A,  $100^\circ\text{C}$  is 180 ns (Typ)
- 700 V Blocking Capability
- SOA and Switching Applications Information
- These Devices are Pb-Free and are RoHS Compliant\*

### MAXIMUM RATINGS

Rating	Symbol	Value	Unit
Collector-Emitter Voltage	$V_{CEO(sus)}$	400	Vdc
Collector-Emitter Voltage	$V_{CEV}$	700	Vdc
Emitter-Base Voltage	$V_{EBO}$	9	Vdc
Collector Current – Continuous – Peak (Note 1)	$I_C$ $I_{CM}$	4 8	Adc
Base Current – Continuous – Peak (Note 1)	$I_B$ $I_{BM}$	2 4	Adc
Emitter Current – Continuous – Peak (Note 1)	$I_E$ $I_{EM}$	6 12	Adc
Total Device Dissipation @ $T_A = 25^\circ\text{C}$ Derate above $25^\circ\text{C}$	$P_D$	2 0.016	W W/ $^\circ\text{C}$
Total Device Dissipation @ $T_C = 25^\circ\text{C}$ Derate above $25^\circ\text{C}$	$P_D$	75 0.6	W W/ $^\circ\text{C}$
Operating and Storage Junction Temperature Range	$T_J, T_{stg}$	-65 to +150	$^\circ\text{C}$

### THERMAL CHARACTERISTICS

Characteristics	Symbol	Max	Unit
Thermal Resistance, Junction-to-Ambient	$R_{\theta JA}$	62.5	$^\circ\text{C}/\text{W}$
Thermal Resistance, Junction-to-Case	$R_{\theta JC}$	1.67	$^\circ\text{C}/\text{W}$
Maximum Lead Temperature for Soldering Purposes 1/8" from Case for 5 Seconds	$T_L$	275	$^\circ\text{C}$

Stresses exceeding Maximum Ratings may damage the device. Maximum Ratings are stress ratings only. Functional operation above the Recommended Operating Conditions is not implied. Extended exposure to stresses above the Recommended Operating Conditions may affect device reliability.

1. Pulse Test: Pulse Width = 5 ms, Duty Cycle  $\leq$  10%.

\*For additional information on our Pb-Free strategy and soldering details, please download the ON Semiconductor Soldering and Mounting Techniques Reference Manual, SOLDERRM/D.



ON Semiconductor®

<http://onsemi.com>

**4 AMPERE  
NPN SILICON  
POWER TRANSISTOR  
400 VOLTS – 75 WATTS**

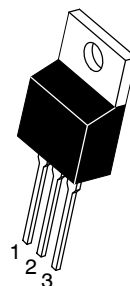

TO-220AB  
CASE 221A-09  
STYLE 1

### MARKING DIAGRAM

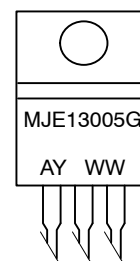

A = Assembly Location  
Y = Year  
WW = Work Week  
G = Pb-Free Package

### ORDERING INFORMATION

Device	Package	Shipping
MJE13005G	TO-220 (Pb-Free)	50 Units / Rail

# MJE13005G

## ELECTRICAL CHARACTERISTICS ( $T_C = 25^\circ\text{C}$ unless otherwise noted)

Characteristic	Symbol	Min	Typ	Max	Unit
<b>OFF CHARACTERISTICS</b> (Note 2)					
Collector–Emitter Sustaining Voltage ( $I_C = 10\text{ mA}$ , $I_B = 0$ )	$V_{CEO(sus)}$	400	–	–	Vdc
Collector Cutoff Current ( $V_{CEV} = \text{Rated Value}$ , $V_{BE(off)} = 1.5\text{ Vdc}$ ) ( $V_{CEV} = \text{Rated Value}$ , $V_{BE(off)} = 1.5\text{ Vdc}$ , $T_C = 100^\circ\text{C}$ )	$I_{CEV}$	–	–	1 5	mAdc
Emitter Cutoff Current ( $V_{EB} = 9\text{ Vdc}$ , $I_C = 0$ )	$I_{EBO}$	–	–	1	mAdc

## SECOND BREAKDOWN

Second Breakdown Collector Current with base forward biased	$I_{S/b}$	–	See Figure 11		
Clamped Inductive SOA with Base Reverse Biased	RBSOA	–	See Figure 12		

## ON CHARACTERISTICS

 (Note 2)

DC Current Gain ( $I_C = 1\text{ Adc}$ , $V_{CE} = 5\text{ Vdc}$ ) ( $I_C = 2\text{ Adc}$ , $V_{CE} = 5\text{ Vdc}$ )	$h_{FE}$	10 8	– –	60 40	–
Collector–Emitter Saturation Voltage ( $I_C = 1\text{ Adc}$ , $I_B = 0.2\text{ Adc}$ ) ( $I_C = 2\text{ Adc}$ , $I_B = 0.5\text{ Adc}$ ) ( $I_C = 4\text{ Adc}$ , $I_B = 1\text{ Adc}$ ) ( $I_C = 2\text{ Adc}$ , $I_B = 0.5\text{ Adc}$ , $T_C = 100^\circ\text{C}$ )	$V_{CE(sat)}$	– – – –	– – – –	0.5 0.6 1 1	Vdc
Base–Emitter Saturation Voltage ( $I_C = 1\text{ Adc}$ , $I_B = 0.2\text{ Adc}$ ) ( $I_C = 2\text{ Adc}$ , $I_B = 0.5\text{ Adc}$ ) ( $I_C = 2\text{ Adc}$ , $I_B = 0.5\text{ Adc}$ , $T_C = 100^\circ\text{C}$ )	$V_{BE(sat)}$	– – –	– – –	1.2 1.6 1.5	Vdc

## DYNAMIC CHARACTERISTICS

Current–Gain – Bandwidth Product ( $I_C = 500\text{ mAdc}$ , $V_{CE} = 10\text{ Vdc}$ , $f = 1\text{ MHz}$ )	$f_T$	4	–	–	MHz
Output Capacitance ( $V_{CB} = 10\text{ Vdc}$ , $I_E = 0$ , $f = 0.1\text{ MHz}$ )	$C_{ob}$	–	65	–	pF

## SWITCHING CHARACTERISTICS

<b>Resistive Load</b> (Table 2)					
Delay Time	$(V_{CC} = 125\text{ Vdc}$ , $I_C = 2\text{ A}$ , $I_{B1} = I_{B2} = 0.4\text{ A}$ , $t_p = 25\text{ }\mu\text{s}$ , Duty Cycle $\leq 1\%$ )	$t_d$	–	0.025	0.1 $\mu\text{s}$
Rise Time		$t_r$	–	0.3	0.7 $\mu\text{s}$
Storage Time		$t_s$	–	1.7	4 $\mu\text{s}$
Fall Time		$t_f$	–	0.4	0.9 $\mu\text{s}$
<b>Inductive Load, Clamped</b> (Table 2, Figure 13)					
Voltage Storage Time	$(I_C = 2\text{ A}$ , $V_{clamp} = 300\text{ Vdc}$ , $I_{B1} = 0.4\text{ A}$ , $V_{BE(off)} = 5\text{ Vdc}$ , $T_C = 100^\circ\text{C}$ )	$t_{sv}$	–	0.9	4 $\mu\text{s}$
Crossover Time		$t_c$	–	0.32	0.9 $\mu\text{s}$
Fall Time		$t_{fi}$	–	0.16	– $\mu\text{s}$

2. Pulse Test: Pulse Width = 300  $\mu\text{s}$ , Duty Cycle = 2%.

# MJE13005G

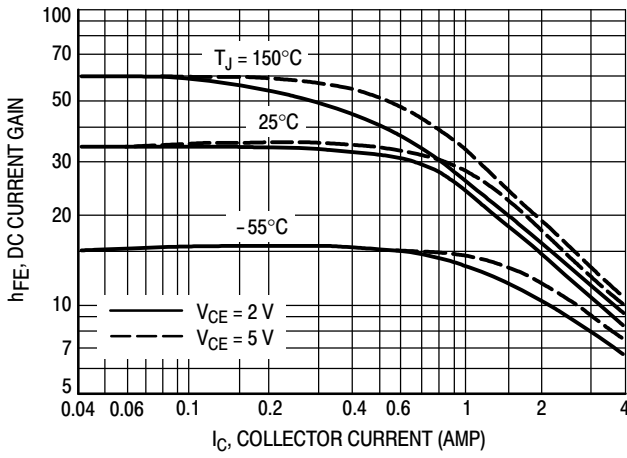

Figure 1. DC Current Gain

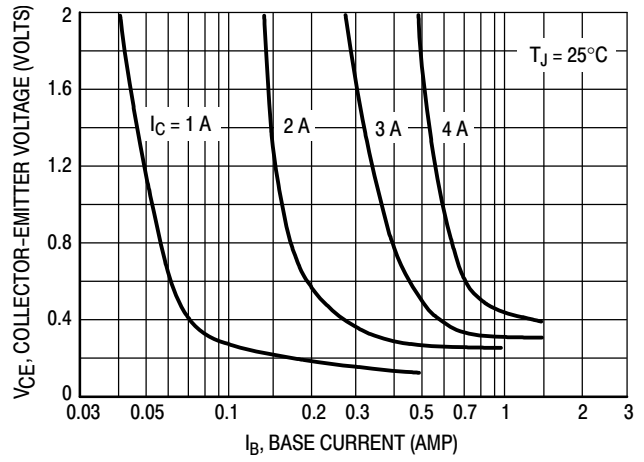

Figure 2. Collector Saturation Region

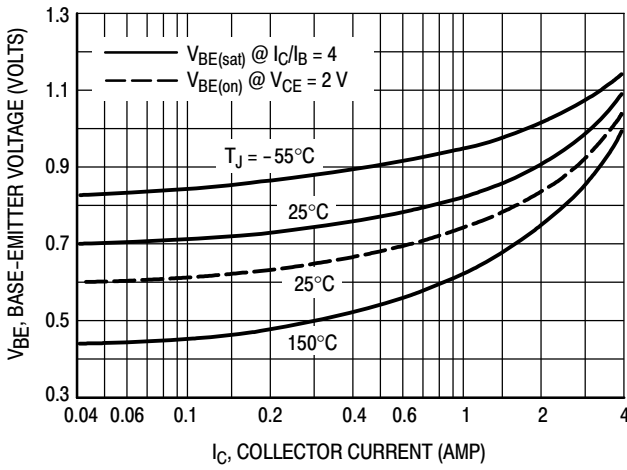

Figure 3. Base-Emitter Voltage

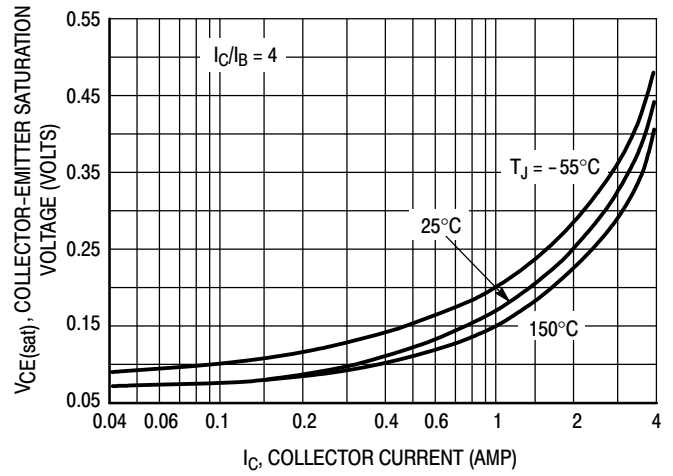

Figure 4. Collector-Emitter Saturation Voltage

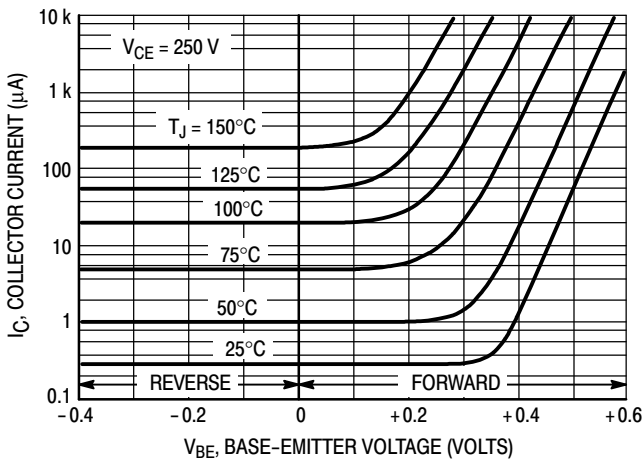

Figure 5. Collector Cutoff Region

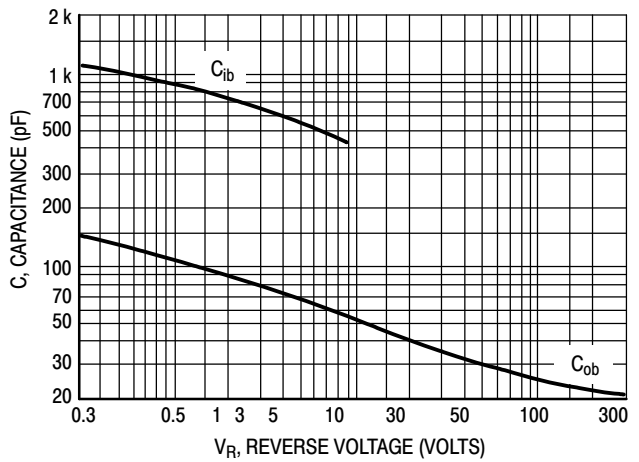

Figure 6. Capacitance



# MJE13005G

Table 2. Test Conditions for Dynamic Performance

REVERSE BIAS SAFE OPERATING AREA AND INDUCTIVE SWITCHING		RESISTIVE SWITCHING
TEST CIRCUITS	<p>DUTY CYCLE <math>\leq 10\%</math>  <math>t_r, t_f \leq 10</math> ns</p> <p>NOTE            PW and <math>V_{CC}</math> Adjusted for Desired <math>I_C</math>  <math>R_B</math> Adjusted for Desired <math>I_{B1}</math></p>	<p>*SELECTED FOR <math>\geq 1</math> kV</p>
CIRCUIT VALUES	Coil Data: Ferroxcube Core #6656 Full Bobbin (~16 Turns) #16 GAP for 200 $\mu$ H/20 A $L_{coil} = 200 \mu$ H $V_{CC} = 20$ V $V_{clamp} = 300$ Vdc	$V_{CC} = 125$ V $R_C = 62 \Omega$ $D1 = 1N5820$ or Equiv. $R_B = 22 \Omega$
TEST WAVEFORMS	<p><math>t_1</math> ADJUSTED TO OBTAIN <math>I_C</math></p> $t_1 \approx \frac{L_{coil} (I_{C(pk)})}{V_{CC}}$ $t_2 \approx \frac{L_{coil} (I_{C(pk)})}{V_{clamp}}$ <p>Test Equipment            Scope-Tektronics            475 or Equivalent</p>	<p><math>t_r, t_f &lt; 10</math> ns            Duty Cycle = 1.0%  <math>R_B</math> and <math>R_C</math> adjusted for desired <math>I_B</math> and <math>I_C</math></p>

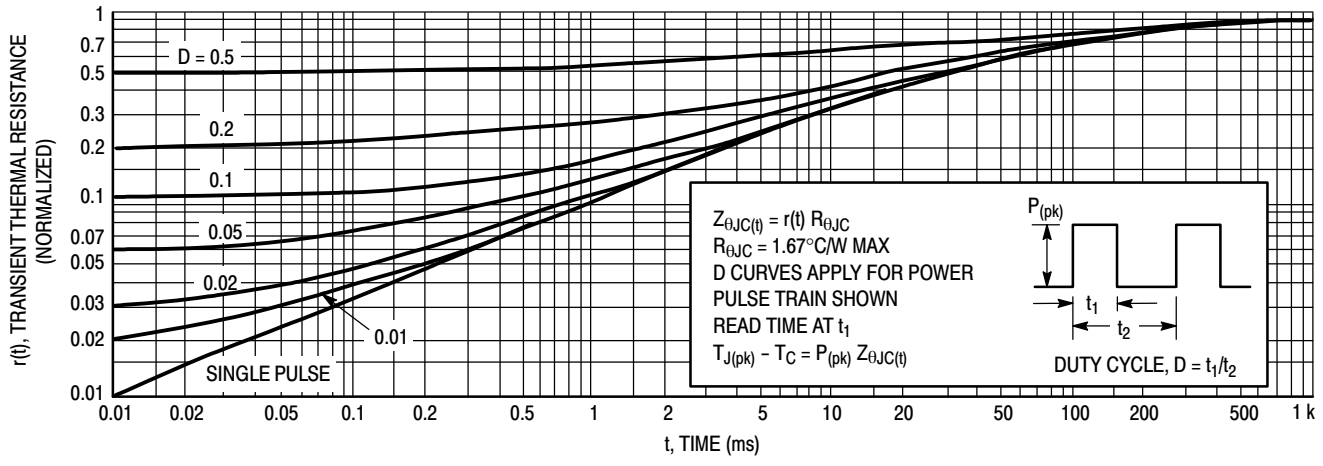

Figure 10. Typical Thermal Response [ $Z_{\theta JC}(t)$ ]

SAFE OPERATING AREA INFORMATION

The Safe Operating Area Figures 11 and 12 are specified ratings for these devices under the test conditions shown.

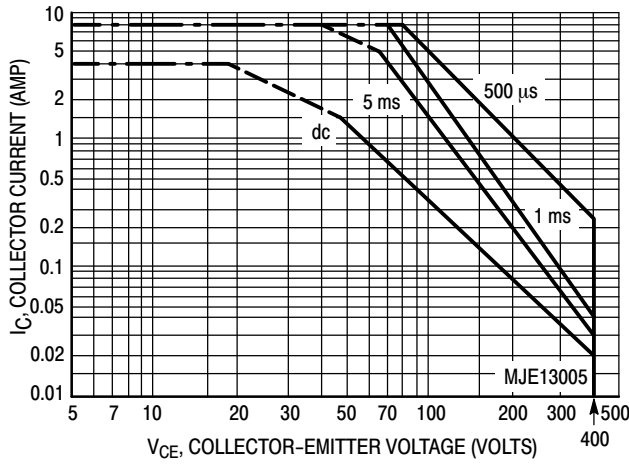

Figure 11. Forward Bias Safe Operating Area

FORWARD BIAS

There are two limitations on the power handling ability of a transistor: average junction temperature and second breakdown. Safe operating area curves indicate  $I_C - V_{CE}$  limits of the transistor that must be observed for reliable operation; i.e., the transistor must not be subjected to greater dissipation than the curves indicate.

The data of Figure 11 is based on  $T_C = 25^\circ\text{C}$ ;  $T_{J(pk)}$  is variable depending on power level. Second breakdown pulse limits are valid for duty cycles to 10% but must be derated when  $T_C \geq 25^\circ\text{C}$ . Second breakdown limitations do not derate the same as thermal limitations. Allowable current at the voltages shown on Figure 11 may be found at any case temperature by using the appropriate curve on Figure 13.

$T_{J(pk)}$  may be calculated from the data in Figure 10. At high case temperatures, thermal limitations will reduce the power that can be handled to values less than the limitations imposed by second breakdown.

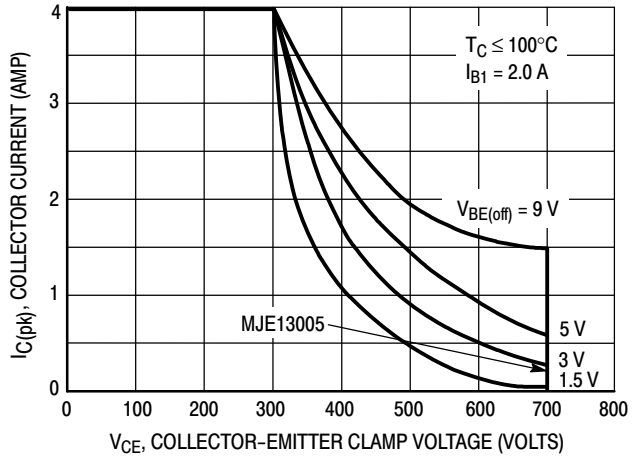

Figure 12. Reverse Bias Switching Safe Operating Area

REVERSE BIAS

For inductive loads, high voltage and high current must be sustained simultaneously during turn-off, in most cases, with the base to emitter junction reverse biased. Under these conditions the collector voltage must be held to a safe level at or below a specific value of collector current. This can be accomplished by several means such as active clamping, RC snubbing, load line shaping, etc. The safe level for these devices is specified as Reverse Bias Safe Operating Area and represents the voltage-current conditions during reverse biased turn-off. This rating is verified under clamped conditions so that the device is never subjected to an avalanche mode. Figure 12 gives the complete RBSOA characteristics.

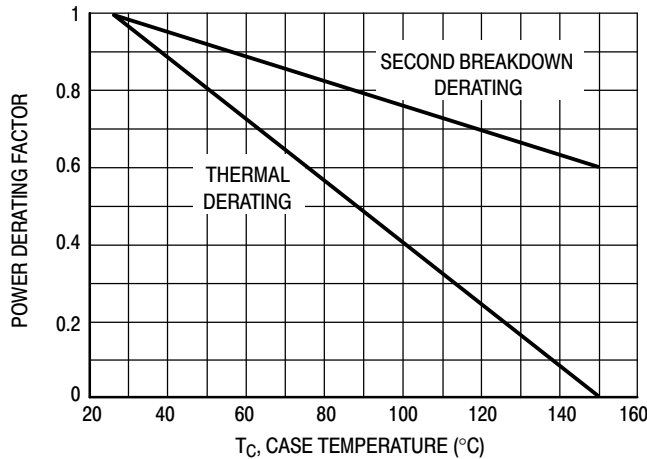
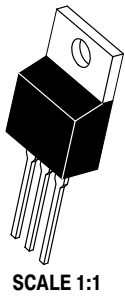

Figure 13. Forward Bias Power Derating

# MECHANICAL CASE OUTLINE PACKAGE DIMENSIONS



## TO-220 CASE 221A ISSUE AK

DATE 13 JAN 2022

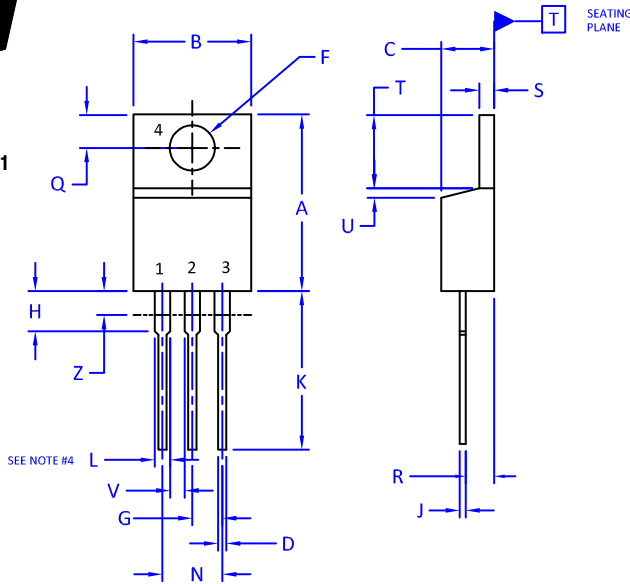

- NOTES:
1. DIMENSIONING AND TOLERANCING PER ANSI Y14.5M, 2009.
  2. CONTROLLING DIMENSION: INCHES
  3. DIMENSION Z DEFINES A ZONE WHERE ALL BODY AND LEAD IRREGULARITIES ARE ALLOWED.
  4. MAX WIDTH FOR F102 DEVICE = 1.35MM

DIM	INCHES		MILLIMETERS	
	MIN.	MAX.	MIN.	MAX.
A	0.570	0.620	14.48	15.75
B	0.380	0.415	9.66	10.53
C	0.160	0.190	4.07	4.83
D	0.025	0.038	0.64	0.96
F	0.142	0.161	3.60	4.09
G	0.095	0.105	2.42	2.66
H	0.110	0.161	2.80	4.10
J	0.014	0.024	0.36	0.61
K	0.500	0.562	12.70	14.27
L	0.045	0.060	1.15	1.52
N	0.190	0.210	4.83	5.33
Q	0.100	0.120	2.54	3.04
R	0.080	0.110	2.04	2.79
S	0.045	0.055	1.15	1.41
T	0.235	0.255	5.97	6.47
U	0.000	0.050	0.00	1.27
V	0.045	---	1.15	---
Z	---	0.080	---	2.04

STYLE 1:  
PIN 1. BASE  
2. COLLECTOR  
3. EMITTER  
4. COLLECTOR

STYLE 2:  
PIN 1. BASE  
2. EMITTER  
3. COLLECTOR  
4. EMITTER

STYLE 3:  
PIN 1. CATHODE  
2. ANODE  
3. GATE  
4. ANODE

STYLE 4:  
PIN 1. MAIN TERMINAL 1  
2. MAIN TERMINAL 2  
3. GATE  
4. MAIN TERMINAL 2

STYLE 5:  
PIN 1. GATE  
2. DRAIN  
3. SOURCE  
4. DRAIN

STYLE 6:  
PIN 1. ANODE  
2. CATHODE  
3. ANODE  
4. CATHODE

STYLE 7:  
PIN 1. CATHODE  
2. ANODE  
3. CATHODE  
4. ANODE

STYLE 8:  
PIN 1. CATHODE  
2. ANODE  
3. EXTERNAL TRIP/DELAY  
4. ANODE

STYLE 9:  
PIN 1. GATE  
2. COLLECTOR  
3. EMITTER  
4. COLLECTOR

STYLE 10:  
PIN 1. GATE  
2. SOURCE  
3. DRAIN  
4. SOURCE

STYLE 11:  
PIN 1. DRAIN  
2. SOURCE  
3. GATE  
4. SOURCE

STYLE 12:  
PIN 1. MAIN TERMINAL 1  
2. MAIN TERMINAL 2  
3. GATE  
4. NOT CONNECTED

DOCUMENT NUMBER:	98ASB42148B	Electronic versions are uncontrolled except when accessed directly from the Document Repository. Printed versions are uncontrolled except when stamped "CONTROLLED COPY" in red.
DESCRIPTION:	TO-220	PAGE 1 OF 1

onsemi and onsemi are trademarks of Semiconductor Components Industries, LLC dba onsemi or its subsidiaries in the United States and/or other countries. onsemi reserves the right to make changes without further notice to any products herein. onsemi makes no warranty, representation or guarantee regarding the suitability of its products for any particular purpose, nor does onsemi assume any liability arising out of the application or use of any product or circuit, and specifically disclaims any and all liability, including without limitation special, consequential or incidental damages. onsemi does not convey any license under its patent rights nor the rights of others.

**onsemi**, **Onsemi**, and other names, marks, and brands are registered and/or common law trademarks of Semiconductor Components Industries, LLC dba "**onsemi**" or its affiliates and/or subsidiaries in the United States and/or other countries. **onsemi** owns the rights to a number of patents, trademarks, copyrights, trade secrets, and other intellectual property. A listing of **onsemi**'s product/patent coverage may be accessed at [www.onsemi.com/site/pdf/Patent-Marking.pdf](http://www.onsemi.com/site/pdf/Patent-Marking.pdf). **onsemi** reserves the right to make changes at any time to any products or information herein, without notice. The information herein is provided "as-is" and **onsemi** makes no warranty, representation or guarantee regarding the accuracy of the information, product features, availability, functionality, or suitability of its products for any particular purpose, nor does **onsemi** assume any liability arising out of the application or use of any product or circuit, and specifically disclaims any and all liability, including without limitation special, consequential or incidental damages. Buyer is responsible for its products and applications using **onsemi** products, including compliance with all laws, regulations and safety requirements or standards, regardless of any support or applications information provided by **onsemi**. "Typical" parameters which may be provided in **onsemi** data sheets and/or specifications can and do vary in different applications and actual performance may vary over time. All operating parameters, including "Typicals" must be validated for each customer application by customer's technical experts. **onsemi** does not convey any license under any of its intellectual property rights nor the rights of others. **onsemi** products are not designed, intended, or authorized for use as a critical component in life support systems or any FDA Class 3 medical devices or medical devices with a same or similar classification in a foreign jurisdiction or any devices intended for implantation in the human body. Should Buyer purchase or use **onsemi** products for any such unintended or unauthorized application, Buyer shall indemnify and hold **onsemi** and its officers, employees, subsidiaries, affiliates, and distributors harmless against all claims, costs, damages, and expenses, and reasonable attorney fees arising out of, directly or indirectly, any claim of personal injury or death associated with such unintended or unauthorized use, even if such claim alleges that **onsemi** was negligent regarding the design or manufacture of the part. **onsemi** is an Equal Opportunity/Affirmative Action Employer. This literature is subject to all applicable copyright laws and is not for resale in any manner.

## PUBLICATION ORDERING INFORMATION

### LITERATURE FULFILLMENT:

Email Requests to: [orderlit@onsemi.com](mailto:orderlit@onsemi.com)

**onsemi Website:** [www.onsemi.com](http://www.onsemi.com)

### TECHNICAL SUPPORT

**North American Technical Support:**  
Voice Mail: 1 800-282-9855 Toll Free USA/Canada  
Phone: 011 421 33 790 2910

**Europe, Middle East and Africa Technical Support:**

Phone: 00421 33 790 2910

For additional information, please contact your local Sales Representative



# Mouser Electronics

Authorized Distributor

Click to View Pricing, Inventory, Delivery & Lifecycle Information:

[onsemi:](#)

[MJE13005](#) [MJE13005G](#)