



GlobalTop Technology Inc.

FGPMMOPA6H

GPS Standalone Module

Data Sheet

Revision: V0A

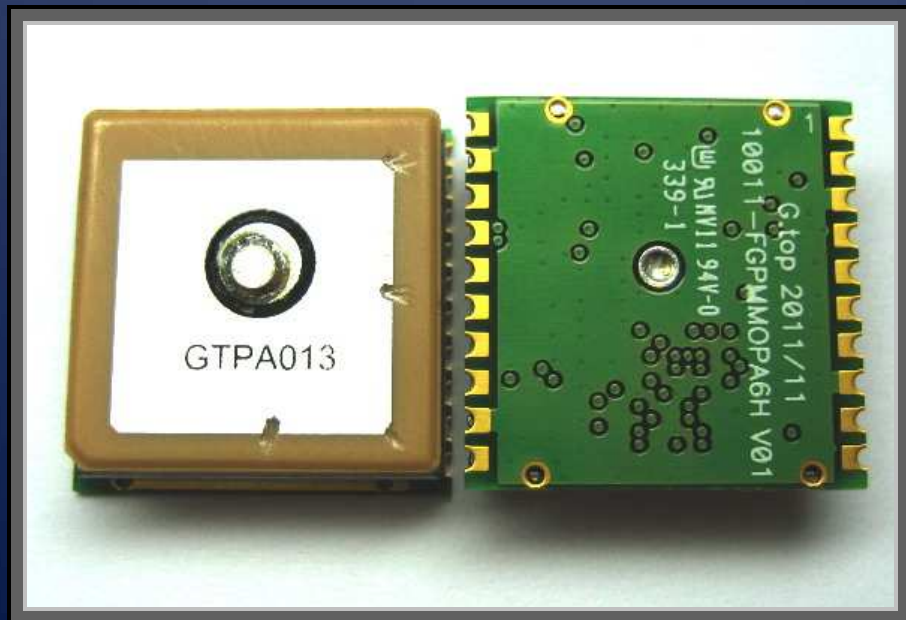

The FGPMMOPA6H is a 4th generation stand-alone GPS module with lightning fast TTFF, ultra high sensitivity (-165dBm), and low power consumption in a small form factor (16*16*4.7mm)

This document is the exclusive property of GlobalTop Tech Inc. and should not be distributed, reproduced, into any other format without prior permission of GlobalTop Tech Inc. Specifications subject to change without prior notice.

Copyright © 2011 GlobalTop Technology Inc. All Rights Reserved.

No.16 Nan-ke 9th Rd, Science-Based Industrial Park, Tainan, 741, Taiwan, R.O.C.

Tel: +886-6-5051268 / Fax: +886-6-5053381 / Email: sales@gtop-tech.com / Web: www.gtop-tech.com



Version History

Title: GlobalTop FGPMMOPA6H Datasheet

Subtitle: GPS Module

Doc Type: Datasheet

Revision	Date	Author	Description
V0A	2012-1-31	Delano	Preliminary

Table of Contents

1. Functional Description	4
1.1 Overview	4
1.2 Highlights and Features	5
1.3 System Block Diagram.....	6
1.4 Multi-tone active interference canceller	7
1.5 1PPS	7
1.6 AGPS Support for Fast TTFF (EPO™)	7
1.7 EASY™	7
1.8 AlwaysLocate™ (Advance Power Periodic Mode).....	9
1.9 Embedded Logger function	9
2.0 Antenna Advisor	9
2. Specifications	10
2.1 Mechanical Dimension	10
2.2 Recommended PCB pad Layout.....	11
2.3 Pin Configuration	12
2.4 Pin Assignment	13
2.5 Description of I/O Pin	14
2.6 Specification List	16
2.7 Absolute Maximum Ratings.....	17
2.8 Operating Conditions.....	17
2.9 GPS External Antenna Specification (Recommended)	17
3. Protocols	18
3.1 NMEA Output Sentences	18
3.2 Antenna Status Protocol (Antenna Advisor).....	24
3.3 MTK NMEA Command Protocols.....	24
3.4 Firmware Customization Services.....	25
4. Reference Design	26
4.1 Reference Design Circuit.....	26
5. Packing and Handling.....	27
5.1 Moisture Sensitivity	27
5.2 Packing.....	28
5.3 Storage and Floor Life Guideline.....	30
5.4 Drying.....	30
5.5 ESD Handling.....	31
6. Reflow Soldering Temperature Profile	32
6.1 SMT Reflow Soldering Temperature Profile.....	32
6.2 Manual Soldering.....	36
7. Contact Information.....	37

1. Functional Description

1.1 Overview

The FGPMMOPA6H utilizes the MediaTek new generation GPS Chipset MT3339 that achieves the industry's highest level of sensitivity (-165dBm) and instant Time-to-First Fix (TTFF) with lowest power consumption for precise GPS signal processing to give the ultra-precise positioning under low receptive, high velocity conditions.

The module a revision of POT (Patch On Top) GPS Module with an extra embedded function for external antenna I/O and comes with **automatic antenna switching function** and short circuit protection, also features a antenna system called "Antenna Advisor" that helps with the detections and notifications of different antenna statuses, including active antenna connection, antenna open circuit and antenna shortage.

Up to 12 multi-tone active interference canceller (ISSCC2011 award), customer can have more flexibility in system design. Supports up to 210 PRN channels with 66 search channels and 22 simultaneous tracking channels, Module supports various location and navigation applications, including autonomous GPS, QZSS, SBAS(note) ranging (WAAS, EGNO, GAGAN, MSAS), AGPS.

FGPMMOPA6H is excellent low power consumption characteristic (acquisition 82mW, tracking 66mW), power sensitive devices, especially portable applications, need not worry about operating time anymore and user can get more fun.

Note: SBAS can only be enabled when update rate is less than or equal to 5Hz.

Application:

- ✓ Handheld Device
- ✓ Tablet PC/PLB/MID
- ✓ M2M application
- ✓ Asset management
- ✓ Surveillance

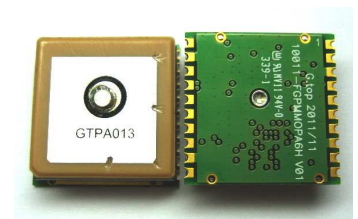

1.2 Highlights and Features

- ◆ Built-in 15X15X2.5mm ceramic patch antenna on the top of module
- ◆ Ultra-High Sensitivity: -165dBm (w/o patch antenna), up to 45dB C/N of SVs in open sky reception.
- ◆ High Update Rate: up to 10Hz^(note1)
- ◆ 12 multi-tone active interference canceller^(note2) [ISSCC 2011 Award -Section 26.5] (http://isscc.org/doc/2011/isscc2011.advanceprogrambooklet_abstracts.pdf)
- ◆ High accuracy 1-PPS timing support for Timing Applications (10ns jitter)
- ◆ AGPS Support for Fast TTFF (EPO™ Enable 7 days/14 days)
- ◆ EASY™^(note2): Self-Generated Orbit Prediction for instant positioning fix
- ◆ AlwaysLocate™^(note2) Intelligent Algorithm (Advance Power Periodic Mode) for power saving
- ◆ Logger function Embedded^(note2)
- ◆ Automatic antenna switching function
- ◆ Antenna Advisor function
- ◆ Gtop Firmware Customization Services
- ◆ Consumption current(@3.3V):
 - Acquisition: 25mA Typical
 - Tracking: 20mA Typical
- ◆ E911, RoHS, REACH compliant

note 1: SBAS can only be enabled when update rate is less than or equal to 5Hz.

note2: Some features need special firmware or command programmed by customer, please refer to G-top "GPS command List"

1.3 System Block Diagram

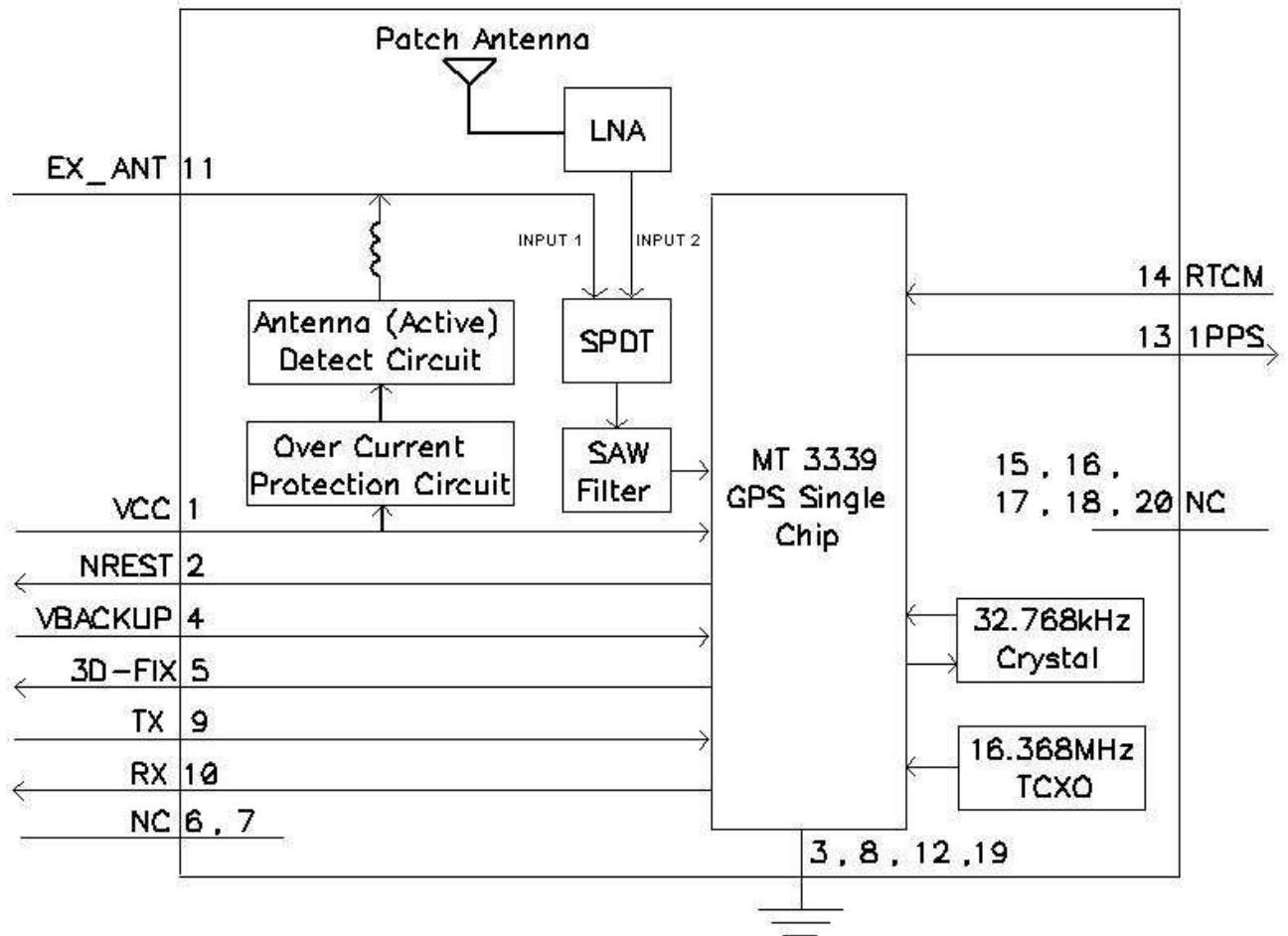

1.4 Multi-tone active interference canceller

Because different application (Wi-Fi, GSM/GPRS, 3G/4G, Bluetooth) are integrated into navigation system, the harmonic of RF signal will influence the GPS reception, The multi-tone active interference canceller (abbr: MTAIC) can reject external RF interference which come from other active components on the main board, to improve the capacity of GPS reception without any needed HW change in the design. PA6H can cancel up to 12 independent channels interference continuous wave (CW)

1.5 1PPS

A pulse per second (1 PPS) is an electrical signal that very precisely indicates the start of a second. Depending on the source, properly operating PPS signals have typical accuracy ranging 10ns.

1 PPS signals are used for precise timekeeping and time measurement. One increasingly common use is in computer timekeeping, including the NTP protocol. A common use for the PPS signal is to connect it to a PC using a low-latency, low-jitter wire connection and allow a program to synchronize to it:

PA6H supply the high accurate 1PPS timing to synchronize to GPS time after 3D-Fix. A power-on output 1pps is also available for customization firmware settings.

1.6 AGPS Support for Fast TTFF (EPO™)

The AGPS (EPO™) supply the predicated Extended Prediction Orbit data to speed TTFF ,users can download the EPO data to GPS engine from the FTP server by internet or wireless network ,the GPS engine will use the EPO data to assist position calculation when the navigation information of satellites are not enough or weak signal zone . About the detail, please link [Gtop website](#).

1.7 EASY™

The EASY™ is embedded assist system for quick positioning, the GPS engine will calculate and predict automatically the single emperies (Max. up to 3 days)when power on ,and save the predict information into the memory , GPS engine will use these information for positioning if no enough information from satellites, so the function will be helpful for positioning and TTFF improvement under indoor or urban condition.

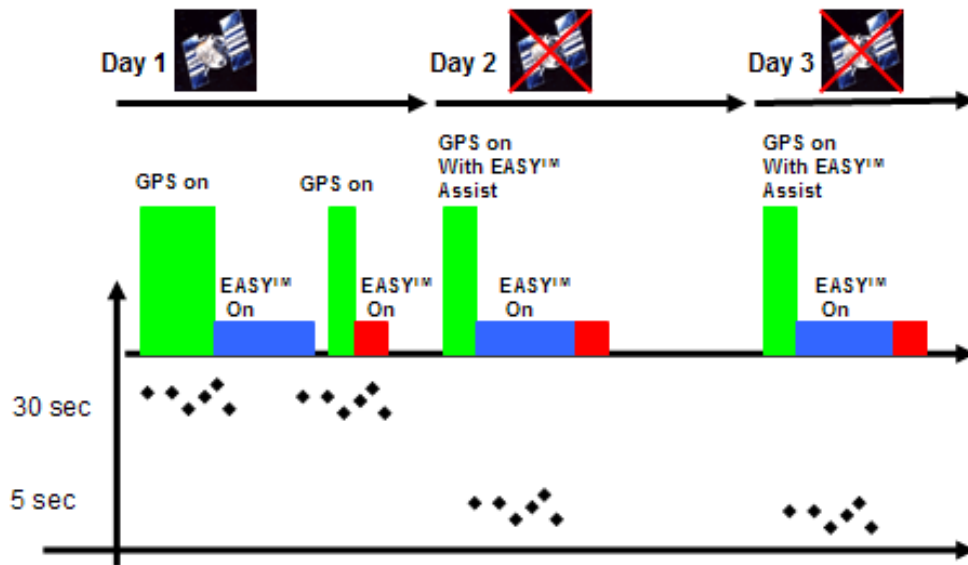

Figure 1.12-1 EASY System operation

Please refer to the Fig 1.12-1, When GPS device great the satellite information from GPS satellites, the GPS engine automatically pre-calculate the predict orbit information for 3 days

The GPS device still can quickly do the positioning with EASY™ function under weak GPS signal.

1.8 AlwaysLocate™ (Advance Power Periodic Mode)

Embedded need to be executed full y all the time , the algorithm can be set by different necessary to decide the operation level of GPS function , reduce power consumption , it will suffer positing accuracy to get the target of power saving and extend the usage time of product . (The positioning accuracy of reporting location < 50m (CEP)

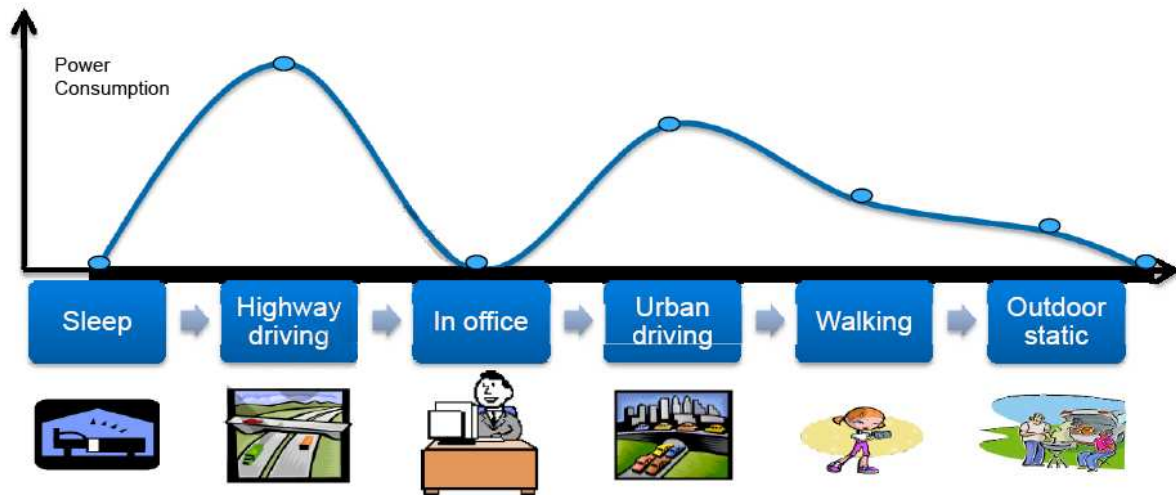

1.9 Embedded Logger function

The Embedded Logger function don't need host CPU (MCU) and external flash to handle the operation , GPS Engine will use internal flash (embedded in GPS chipset) to log the GPS data (Data format : UTC, Latitude , longitude, Valid ,Checksum), the max log days can up to 2 days under AlwaysLocate™ condition .^{Note}

Note: Data size per log was shrunk from 24 bytes to 15 bytes.

2.0 Antenna Advisor

“Antenna Advisor” is a brand new antenna system available exclusively for PA6H. It is designed to detect and notify antenna status using software (through proprietary protocol on **Chapter 3.2**).

Antenna Advisor can detect and notify the following:

- Active Antenna Shorted
- Using Internal Antenna
- Using Active Antenna

2. Specifications

2.1 Mechanical Dimension

Dimension: (Unit: mm, Tolerance: +/- 0.2mm)

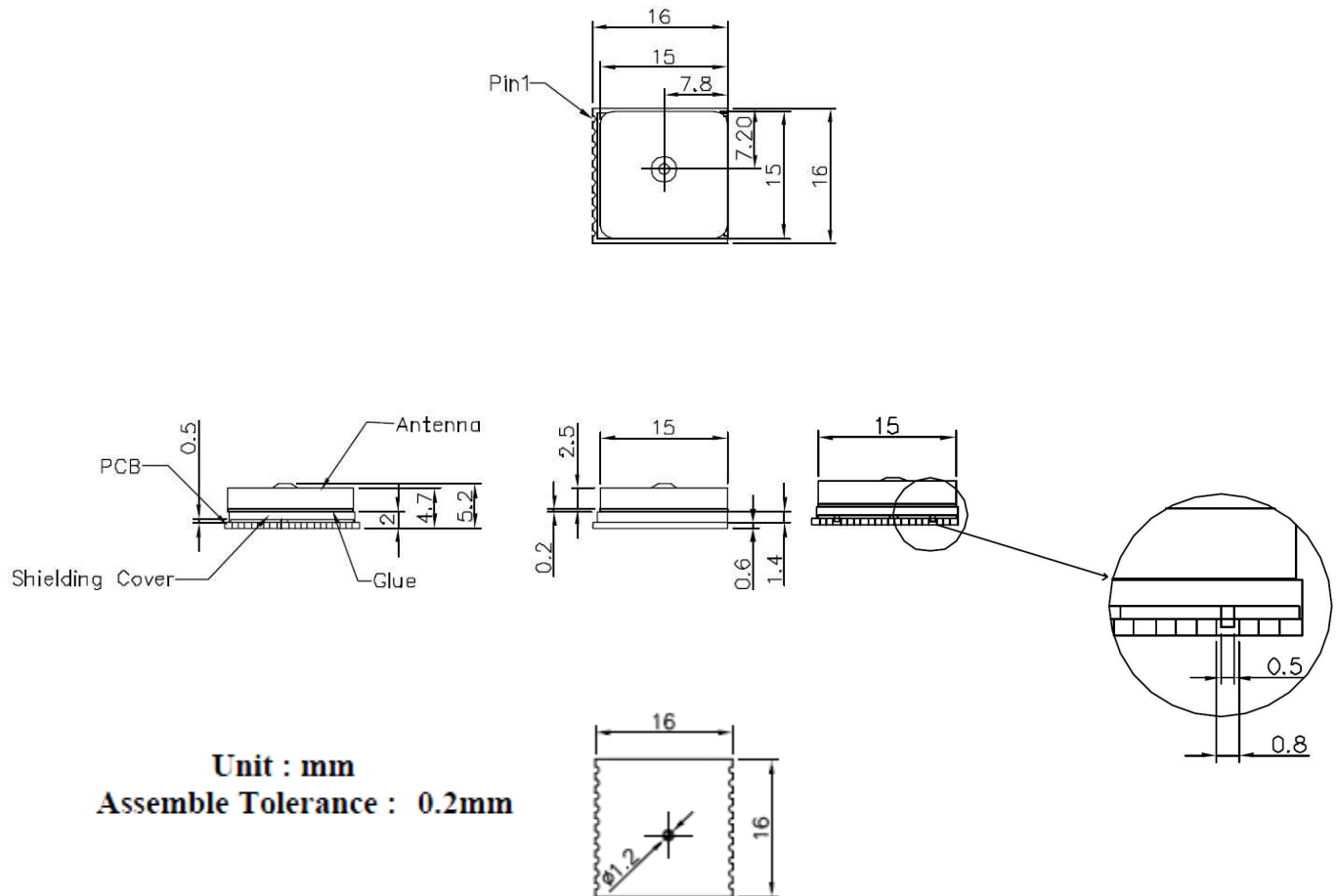

2.2 Recommended PCB pad Layout

(Unit: mm, Tolerance: 0.1mm)

FGPMMOPA6H Footprint

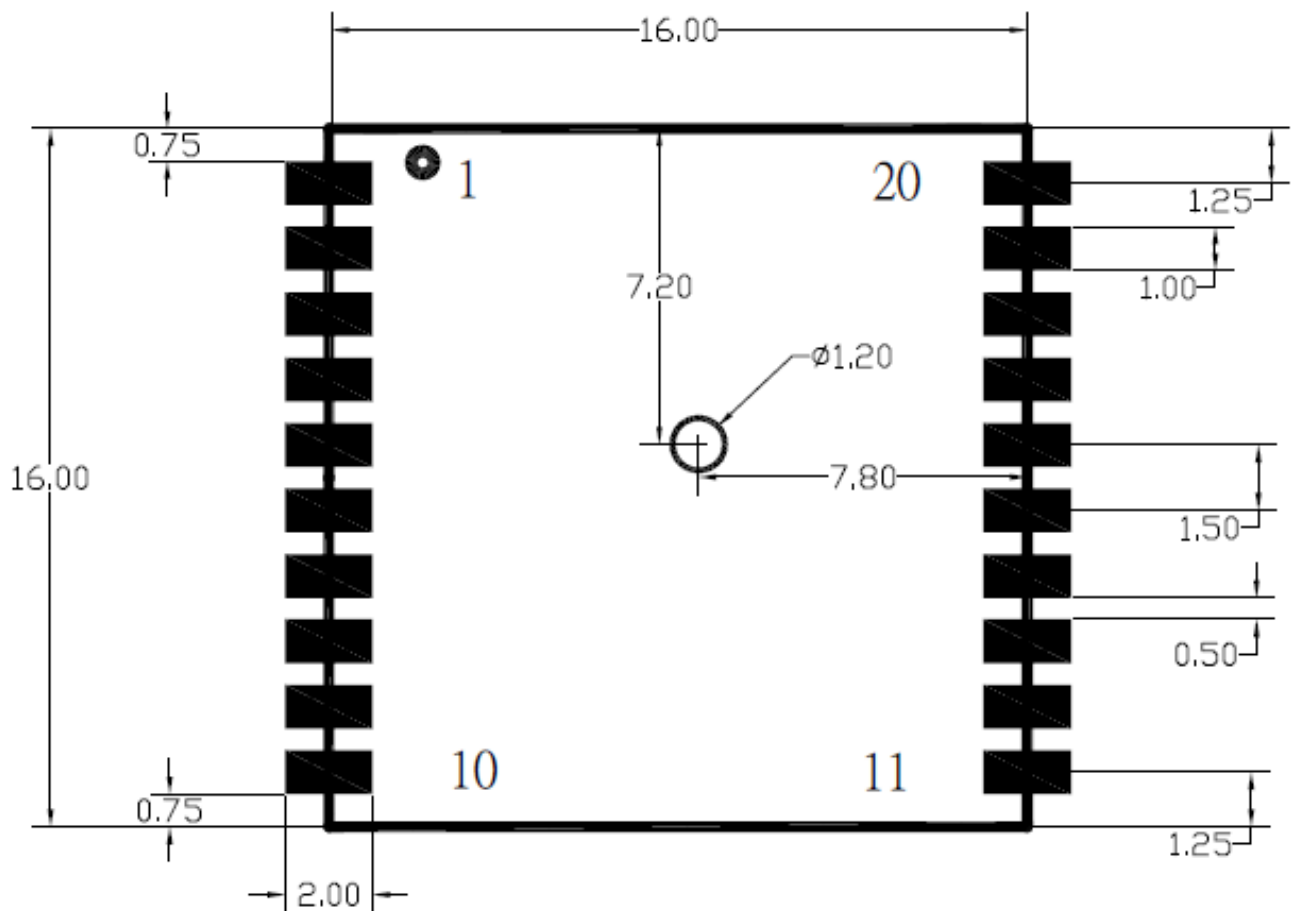

(Top view)

(Unit : mm, Tolerance : 0.1mm)

2.3 Pin Configuration

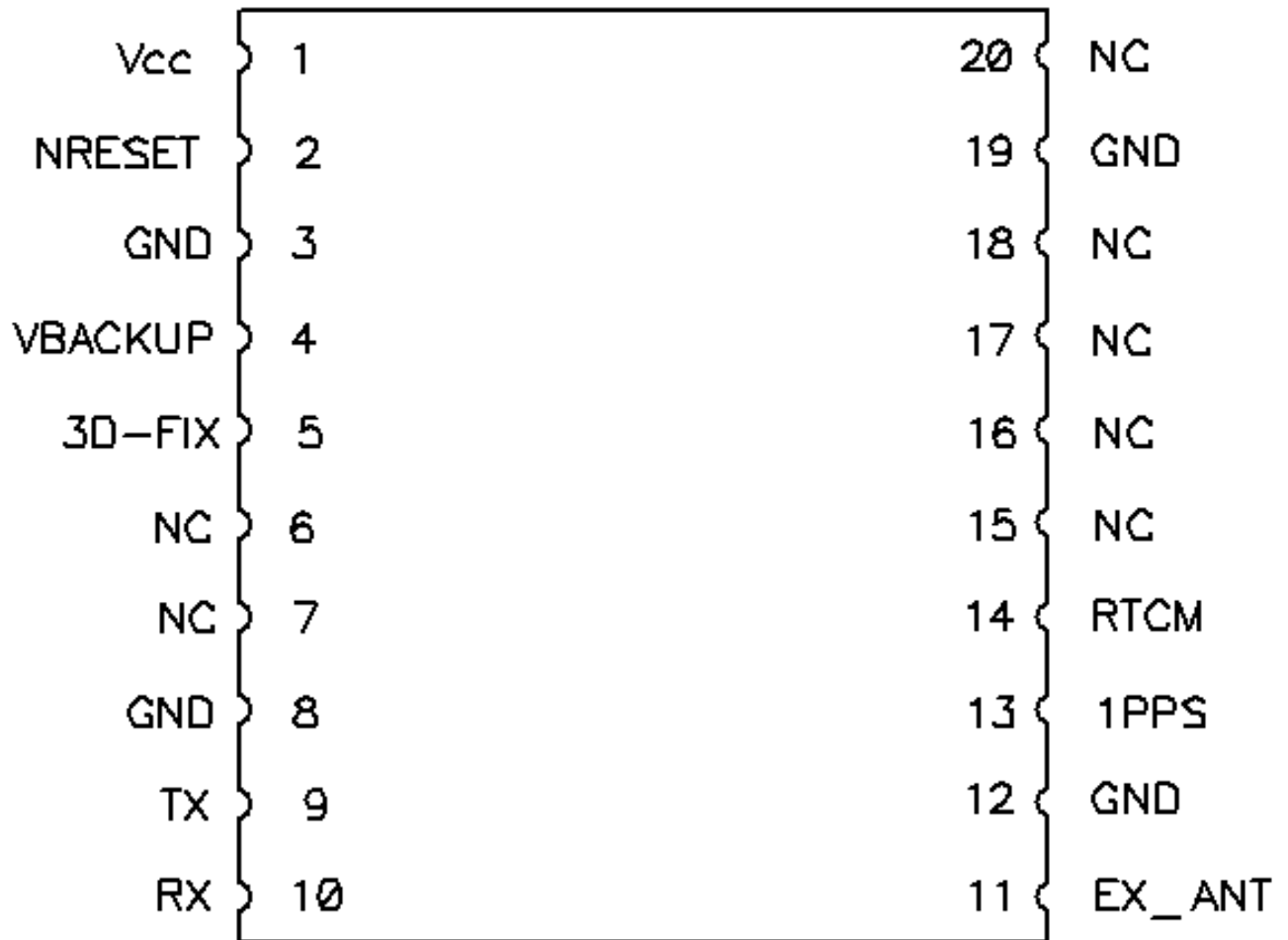

(Top view)

2.4 Pin Assignment

Pin	Name	I/O	Description & Note
1	VCC	PI	Main DC Power Input
2	NRESET	I	Reset Input, Low Active
3	GND	P	Ground
4	VBACKUP	PI	Backup Power Input for RTC & Navigation Data Retention
5	3D-FIX	O	3D-Fix Indicator
6	NC	--	Not Connect
7	NC	--	Not Connect
8	GND	P	Ground
9	TX	O	Serial Data Output for NMEA Output (UART TTL)
10	RX	I	Serial Data Input for Firmware Update (UART TTL)
11	EX_ANT	I PO	External active antenna RF input. DC power from VCC and provide for external active antenna.
12	GND	P	Ground
13	1PPS	O	1PPS Time Mark Output 2.8V CMOS Level
14	RTCM	I	Serial Data Input for DGPS RTCM Data Streaming
15	NC	--	Not Connect
16	NC	--	Not Connect
17	NC	--	Not Connect
18	NC	--	Not Connect
19	GND	P	Ground
20	NC	--	Not Connect

2.5 Description of I/O Pin

VCC (Pin1)

The main DC power supply of the module, the voltage should be kept between from 3.0V to 4.3V.
The Vcc ripple must be controlled under 50mV_{pp} (Typical: 3.3V)

NRESET (Pin2)

With a low level, it causes the module to reset. If not used, keep floating.

GND (Pin3, Pin8, Pin12, Pin19)

Ground

VBACKUP (Pin4)

This connects to the backup power of the GPS module. Power source (such as battery) connected to this pin will help the GPS chipset in keeping its internal RTC running when the main power source is turned off. The voltage should be kept between **2.0V~4.3V, Typical 3.0V**.

IF VBACKUP power was not reserved, the GPS module will perform a lengthy cold start every time it is powered-on because previous satellite information is not retained and needs to be re-transmitted.

If not used, keep open.

3D-FIX (Pin5)

The 3D-FIX is assigned as a fix flag output. The timing behavior of this pin can be configured by custom firmware for different applications (Example: waking up host MCU). If not used, keep floating.

- Before 2D Fix

The pin should continuously output one-second high-level with one-second low-level signal.

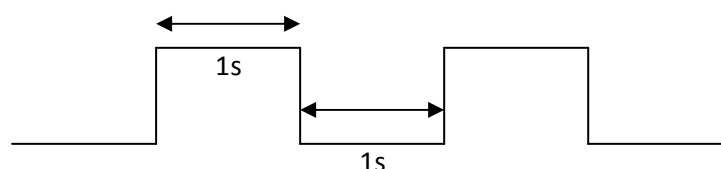

- After 2D or 3D Fix
The pin should continuously output low-level signal.

Low _____

NC (Pin6, Pin7, Pin15, Pin16, Pin17, Pin18, Pin20)

Not connect.

TX (Pin9)

This is the UART transmitter of the module. It outputs the GPS information for application.

RX (Pin10)

This is the UART receiver of the module. It is used to receive software commands and firmware update.

EX_ANT (Pin11)

DC power from VCC and provide for external active antenna (Recommendation: 3.3V).

When a 4mA or higher current is detected, the detect circuit will acknowledge the external antenna as being present and uses external antenna for reception.

In the event of short circuit occurring at external antenna, the module will limit the drawn current to a safe level.

The 3.0V for the GPS external antenna is limited to 25mA.

The 3.3V for the GPS external antenna is limited to 28mA.

The 3.6V for the GPS external antenna is limited to 31mA.

1PPS (Pin13)

This pin provides one pulse-per-second output from the module and synchronizes to GPS time.

Keep floating if not used.

RTCM (Pin14)

This pin receive DGPS data of RTCM protocol (TTL level), if not used keep floating'

RTCM is not enabled by default, please consult GlobalTop support to enable this feature.

2.6 Specification List

	Description
GPS Solution	MTK MT3339
Frequency	L1, 1575.42MHz
Sensitivity¹	Acquisition: -148dBm, cold start Reacquisition: -163dBm, Hot start Tracking: -165dBm
Channel	66 channels
TTF	Hot start: 1 second typical Warm start: 33 seconds typical Cold start: 35 seconds typical (No. of SVs>4, C/N>40dB, PDop<1.5)
Position Accuracy	Without aid:3.0m (50% CEP) DGPS(SBAS(WAAS,EGNOS,MSAS)):2.5m (50% CEP)
Velocity Accuracy	Without aid : 0.1m/s DGPS(SBAS(WAAS,EGNOS,MSAS,GAGAN)):0.05m/s
Timing Accuracy (1PPS Output)	10 ns(Typical)
Altitude	Maximum 18,000m (60,000 feet)
Velocity	Maximum 515m/s (1000 knots)
Acceleration	Maximum 4G
Update Rate	1Hz (default), maximum 10Hz
Baud Rate	9600 bps (default)
DGPS	SBAS(default) [WAAS, EGNOS, MSAS,GAGAN]
QZSS	Support(Ranging)
AGPS	Support
Power Supply	VCC : 3.0V to 4.3V ; VBACKUP : 2.0V to 4.3V
Current Consumption	25mA acquisition, 20mA tracking
Working Temperature	-40 °C to +85 °C
Dimension	16 x 16x 4.7mm, SMD
Weight	4g

2.7 Absolute Maximum Ratings

The voltage applied for VCC should not exceed 4.3VDC.

	Symbol	Min.	Typ.	Max.	Unit
Power Supply Voltage	VCC	3.0	3.3	4.3	V
Backup battery Voltage	VBACKUP	2.0	3.0	4.3	V

2.8 Operating Conditions

	Condition	Min.	Typ.	Max.	Unit
Operation supply Ripple Voltage	—	—	—	50	mVpp
RX0 TTL H Level	VCC=3.0~4.3V	2.0	—	VCC	V
RX0 TTL L Level	VCC=3.0~4.3V	0	—	0.8	V
TX0 TTL H Level	VCC=3.0~4.3V	2.4	—	2.8	V
TX0 TTL L Level	VCC=3.0~4.3V	0	—	0.4	V
Current Consumption @ 3.3V, 1Hz Update Rate	Acquisition	—	25	—	mA
	Tracking	—	20	—	mA
Backup Power Consumption@ 3V	25°C	—	7	—	uA

2.9 GPS External Antenna Specification (Recommended)

It is important that the antenna gets a clear view of the sky and is positioned on a surface level to the horizon for best results. The following specification has to meet for the use reference design.

Characteristic	Specification
Polarization	Right-hand circular polarized
Frequency Received	1.57542GHz +/- 1.023MHz
Power Supply	3V to 3.6V
DC Current	4mA ~ 20mA at 3.3V
Total Gain	>+ 15dBi (Two-stage LNA)
Output VSWR	< 2.5
Impedance	50ohm
Noise Figure	< 1.5dB

3. Protocols

3.1 NMEA Output Sentences

Table-1 lists each of the NMEA output sentences specifically developed and defined by MTK for use within MTK products

Table-1: NMEA Output Sentence	
Option	Description
GGA	Time, position and fix type data.
GSA	GPS receiver operating mode, active satellites used in the position solution and DOP values.
GSV	The number of GPS satellites in view satellite ID numbers, elevation, azimuth, and SNR values.
RMC	Time, date, position, course and speed data. Recommended Minimum Navigation Information.
VTG	Course and speed information relative to the ground.

GGA—Global Positioning System Fixed Data. Time, Position and fix related data

Table-2 contains the values for the following example :

\$GPGGA,064951.000,2307.1256,N,12016.4438,E,1,8,0.95,39.9,M,17.8,M,,*65

Table-2: GGA Data Format			
Name	Example	Units	Description
Message ID	\$GPGGA		GGA protocol header
UTC Time	064951.000		hhmmss.sss
Latitude	2307.1256		ddmm.mmmm
N/S Indicator	N		N=north or S=south
Longitude	12016.4438		dddmm.mmmm
E/W Indicator	E		E=east or W=west
Position Indicator	Fix 1		See Table-3
Satellites Used	8		Range 0 to 14
HDOP	0.95		Horizontal Dilution of Precision
MSL Altitude	39.9	meters	Antenna Altitude above/below mean-sea-level
Units	M	meters	Units of antenna altitude
Geoidal Separation	17.8	meters	
Units	M	meters	Units of geoids separation
Age of Diff. Corr.		second	Null fields when DGPS is not used
Checksum	*65		
<CR> <LF>			End of message termination

Table-3: Position Fix Indicator	
Value	Description
0	Fix not available
1	GPS fix
2	Differential GPS fix

GSA—GNSS DOP and Active Satellites

Table-4 contains the values for the following example :

\$GPGSA,A,3,29,21,26,15,18,09,06,10,,,,,2.32,0.95,2.11*00

Table-4: GSA Data Format			
Name	Example	Units	Description
Message ID	\$GPGSA		GSA protocol header
Mode 1	A		See Table-5
Mode 2	3		See Table-6
Satellite Used	29		SV on Channel 1
Satellite Used	21		SV on Channel 2
....
Satellite Used			SV on Channel 12
PDOP	2.32		Position Dilution of Precision
HDOP	0.95		Horizontal Dilution of Precision
VDOP	2.11		Vertical Dilution of Precision
Checksum	*00		
<CR> <LF>			End of message termination

Table-5: Mode 1	
Value	Description
M	Manual—forced to operate in 2D or 3D mode
A	2D Automatic—allowed to automatically switch 2D/3D

Table-6: Mode 2	
Value	Description
1	Fix not available
2	2D (< 4 SVs used)
3	3D (\geq 4 SVs used)

GSV—GNSS Satellites in View

Table-7 contains the values for the following example :

\$GPGSV,3,1,09,29,36,029,42,21,46,314,43,26,44,020,43,15,21,321,39*7D

\$GPGSV,3,2,09,18,26,314,40,09,57,170,44,06,20,229,37,10,26,084,37*77

\$GPGSV,3,3,09,07,,,26*73

Table-7: GSV Data Format			
Name	Example	Units	Description
Message ID	\$GPGSV		GSV protocol header
Number of Messages	3		Range 1 to 3 (Depending on the number of satellites tracked, multiple messages of GSV data may be required.)
Message Number1	1		Range 1 to 3
Satellites in View	09		
Satellite ID	29		Channel 1 (Range 1 to 32)
Elevation	36	degrees	Channel 1 (Maximum 90)
Azimuth	029	degrees	Channel 1 (True, Range 0 to 359)
SNR (C/No)	42	dBHz	Range 0 to 99, (null when not tracking)
....
Satellite ID	15		Channel 4 (Range 1 to 32)
Elevation	21	degrees	Channel 4 (Maximum 90)
Azimuth	321	degrees	Channel 4 (True, Range 0 to 359)
SNR (C/No)	39	dBHz	Range 0 to 99, (null when not tracking)
Checksum	*7D		
<CR> <LF>			End of message termination

RMC—Recommended Minimum Navigation Information

Table-8 contains the values for the following example :

\$GPRMC,064951.000,A,2307.1256,N,12016.4438,E,0.03,165.48,260406,3.05,W,A*2C

Table-8: RMC Data Format			
Name	Example	Units	Description
Message ID	\$GPRMC		RMC protocol header
UTC Time	064951.000		hhmmss.sss
Status	A		A=data valid or V=data not valid
Latitude	2307.1256		ddmm.mmmm
N/S Indicator	N		N=north or S=south
Longitude	12016.4438		dddmm.mmmm
E/W Indicator	E		E=east or W=west
Speed over Ground	0.03	knots	
Course over Ground	165.48	degrees	True
Date	260406		ddmmyy
Magnetic Variation	3.05, W	degrees	E=east or W=west (Need GlobalTop Customization Service)
Mode	A		A= Autonomous mode D= Differential mode E= Estimated mode
Checksum	*2C		
<CR> <LF>			End of message termination

VTG—Course and speed information relative to the ground

Table-9 contains the values for the following example:

\$GPVTG,165.48,T,,M,0.03,N,0.06,K,A*37

Table-9: VTG Data Format			
Name	Example	Units	Description
Message ID	\$GPVTG		VTG protocol header
Course	165.48	degrees	Measured heading
Reference	T		True
Course		degrees	Measured heading
Reference	M		Magnetic (Need GlobalTop Customization Service)
Speed	0.03	knots	Measured horizontal speed
Units	N		Knots
Speed	0.06	km/hr	Measured horizontal speed
Units	K		Kilometers per hour
Mode	A		A= Autonomous mode D= Differential mode E= Estimated mode
Checksum	*06		
<CR> <LF>			End of message termination

3.2 Antenna Status Protocol (Antenna Advisor)

The function is for external active antenna only.

PGTOP—Status of antenna

Table-12 contains the values for the following example:

\$PGTOP,11,3 *6F

Table-12: PGACK Data Format			
Name	Example	Units	Description
Message ID	\$PGTOP		Protocol header
Command ID	11		Function Type
Reference	3		Value of antenna status

Example:

\$PGTOP,11,value*checksum

Value: 1=>Active Antenna Shorted

2=>Using Internal Antenna

3=>Using Active Antenna

3.3 MTK NMEA Command Protocols

Packet Type:

103 PMTK_CMD_COLD_START

Packet Meaning:

Cold Start : Don't use Time, Position, Almanacs and Ephemeris data at re-start.

Example:

\$PMTK103*30<CR><LF>

3.4 Firmware Customization Services

GlobalTop also offers flexible, value-adding GPS firmware customization services that maximizes the over system efficiencies and power consumptions. Latest functions like Binary Mode, 1-Sentence Output, Geo-fencing and Last Position Retention, please see our website at www.gtop-tech.com under Products / GPS Modules / Software Services for more details.

Note: Not all firmware customization services listed below are supported by module. Please contact GlobalTop Sales or Technical Support for more details.



The infographic features a central image of a Mediatek MT3329 GPS chip. Surrounding the chip are eight service categories, each with a brief description:

- AGPS**: fast position fix with preloaded ephemeris
- BINARY MODE**: outputs position in binary format for increase efficiency
- PERIODIC MODE**: saves battery by powering off unused components
- DISTANCE CALCULATION**: calculates line of sight distance between receiver and other points of interest
- TIMING MODE**: advanced 1 PPS control for synchronization equipments
- DATA LOGGER SOLUTION**: turns GPS receiver into data logger with additional flash memory
- 10 HZ UPDATE**: fast refresh rate for high speed applications
- LAST POSITION RETENTION**: outputs last known position coordinates after losing GPS satellite fix
- ONE SENTENCE**: decreases calculation load on processor by simplifying output NMEA sentences

4. Reference Design

This chapter introduces the reference schematic design for the best performance. Additional tips and cautions on design are well documented on Application Note, which is available upon request.

4.1 Reference Design Circuit

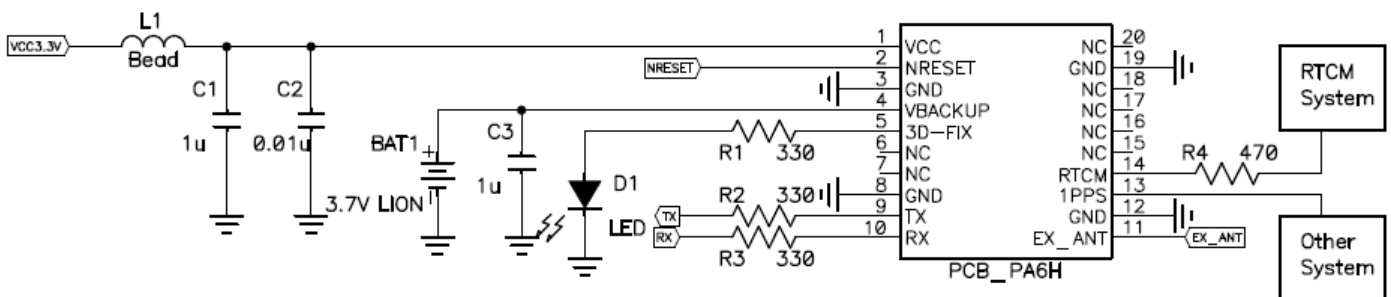

Note:

1. Ferrite bead L1 is added for power noise reduction.
2. C1 and C2 bypass should be put near the module.
3. Damping resistors R2,R3,R4 could be modified based on system application for EMI.
4. If you need more support and information on antenna implementation, please directly contact us at sales@gtop-tech.com for further services.

5. Packing and Handling

GPS modules, like any other SMD devices, are sensitive to moisture, electrostatic discharge, and temperature. By following the standards outlined in this document for GlobalTop GPS module storage and handling, it is possible to reduce the chances of them being damaged during production set-up. This document will go through the basics on how GlobalTop packages its modules to ensure they arrive at their destination without any damages and deterioration to performance quality, as well as some cautionary notes before going through the surface mount process.



Please read the sections II to V carefully to avoid damages permanent damages due to moisture intake



GPS receiver modules contain highly sensitive electronic circuits and are electronic sensitive devices and improper handling without ESD protections may lead to permanent damages to the modules. Please read section VI for more details.

5.1 Moisture Sensitivity

GlobalTop GPS modules are moisture sensitive, and must be pre-baked before going through the solder reflow process. It is important to know that:

GlobalTop GPS modules must complete solder reflow process in 72 hours after pre-baking.

This maximum time is otherwise known as “Floor Life”

If the waiting time has exceeded 72 hours, it is possible for the module to suffer damages during the solder reflow process such as cracks and delamination of the SMD pads due to excess moisture pressure.

5.2 Packing

GlobalTop GPS modules are packed in such a way to ensure the product arrives to SMD factory floor without any damages.

GPS modules are placed individually on to the packaging tray. The trays will then be stacked and packaged together.

Included are:

1. Two packs of desiccant for moisture absorption
2. One moisture level color coded card for relative humidity percentage.

Each package is then placed inside an antistatic bag (or PE bag) that prevents the modules from being damaged by electrostatic discharge.



Figure 1: One pack of GPS modules

Each bag is then carefully placed inside two levels of cardboard carton boxes for maximum protection.



Figure 2: Box protection

The moisture color coded card provides an insight to the relative humidity percentage (RH). When the GPS modules are taken out, it should be around or lower than 30% RH level.

Outside each electrostatic bag is a caution label for moisture sensitive device.

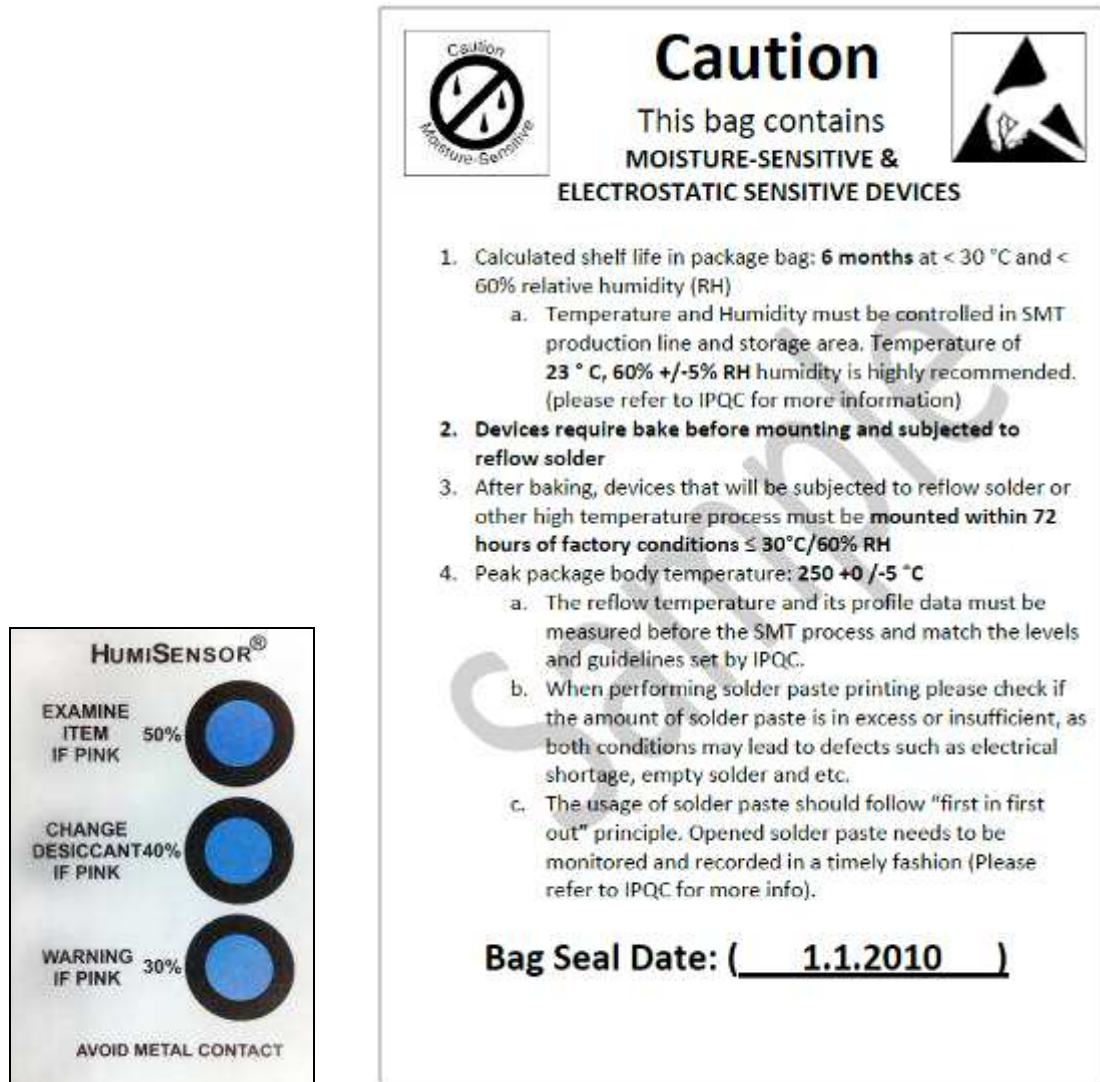

Figure 3: Example of moisture color coded card and caution label

5.3 Storage and Floor Life Guideline

Since GlobalTop modules must undergo solder-reflow process in 72 hours after it has gone through pre-baking procedure, therefore if it is not used by then, it is recommended to store the GPS modules in dry places such as dry cabinet.

The approximate shelf life for GlobalTop GPS modules packages is 6 months from the bag seal date, when store in a non-condensing storage environment (<30°C/60% RH)

 **It is important to note that it is a required process for GlobalTop GPS modules to undergo pre-baking procedures, regardless of the storage condition.**

5.4 Drying

Because the vapor pressures of moisture inside the GPS modules increase greatly when it is exposed to high temperature of solder reflow, in order to prevent internal delaminating, cracking of the devices, or the “popcorn” phenomenon, it is a **necessary requirement** for GlobalTop GPS module to undergo pre-baking procedure before any high temperature or solder reflow process.

The recommendation baking time for GlobalTop GPS module is as follows:

- ✓ **60°C for 8 to 12 hours**

Once baked, the module’s floor life will be “reset”, and has additional 72 hours in normal factory condition to undergo solder reflow process.

 **Please limit the number of times the GPS modules undergoes baking processes as repeated baking process has an effect of reducing the wetting effectiveness of the SMD pad contacts. This applies to all SMT devices.**

 **Oxidation Risk: Baking SMD packages may cause oxidation and/or intermetallic growth of the terminations, which if excessive can result in solderability problems during board assembly. The temperature and time for baking SMD packages are therefore limited by solderability considerations. The cumulative bake time at a temperature greater than 90°C and up to 125°C shall not exceed 96 hours. Bake temperatures higher than 125°C are now allowed.**

5.5 ESD Handling



Please carefully follow the following precautions to prevent severe damage to GPS modules.

GlobalTop GPS modules are sensitive to electrostatic discharges, and thus are Electrostatic Sensitive Devices (ESD). Careful handling of the GPS modules and in particular to its patch antenna (if included) and RF_IN pin, must follow the standard ESD safety practices:

- ✓ Unless there is a galvanic coupling between the local GND and the PCB GND, then the first point of contact when handling the PCB shall always be between the local GND and PCB GND.
- ✓ Before working with RF_IN pin, please make sure the GND is connected
- ✓ When working with RF_IN pin, do not contact any charges capacitors or materials that can easily develop or store charges such as patch antenna, coax cable, soldering iron.
- ✓ Please do not touch the mounted patch antenna to prevent electrostatic discharge from the RF input
- ✓ When soldering RF_IN pin, please make sure to use an ESD safe soldering iron (tip).

6. Reflow Soldering Temperature Profile

The following reflow temperature profile was evaluated by GlobalTop and has been proven to be reliable qualitatively. Please contact us beforehand if you plan to solder this component using a deviated temperature profile as it may cause significant damage to our module and your device.

All the information in this sheet can only be used only for Pb-free manufacturing process.

6.1 SMT Reflow Soldering Temperature Profile (Reference Only)

Average ramp-up rate (25 ~ 150°C): 3°C/sec. max.

Average ramp-up rate (270°C to peak): 3°C/sec. max.

Preheat: 175 ± 25°C, 60 ~ 120 seconds

Temperature maintained above 217°C: 60~150 seconds

Peak temperature: 250 +0/-5°C, 20~40 seconds

Ramp-down rate: 6°C/sec. max.

Time 25°C to peak temperature: 8 minutes max.

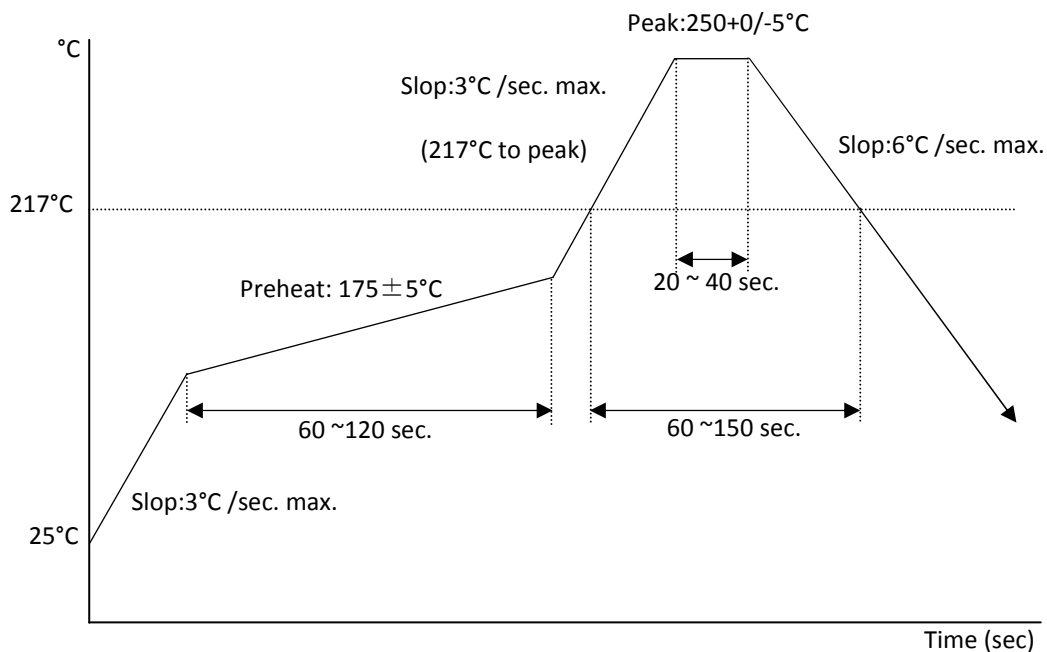

	Details	Suggestions	Notes
1	Before proceeding with the reflow-soldering process, the GPS module must be pre-baked.	Pre-bake Time: 6 Hours @ 60°±5°C or 4 Hours @ 70°±5°C	The maximum tolerated temperature for the tray is 100°C. After the pre-baking process, please make sure the temperature is sufficiently cooled down to 35°C or below in order to prevent any tray deformation.
2	Because PCBA (along with the patch antenna) is highly endothermic during the reflow-soldering process, extra care must be paid to the GPS module's solder joint to see if there are any signs of cold weld(ing) or false welding.	The parameters of the reflow temperature must be set accordingly to module's reflow-soldering temperature profile.	Double check to see if the surrounding components around the GPS module are displaying symptoms of cold weld(ing) or false welding.
3	Special attentions are needed for PCBA board during reflow-soldering to see if there are any symptoms of bending or deformation to the PCBA board, possibility due to the weight of the module. If so, this will cause concerns at the latter half of the production process.	A loading carrier fixture must be used with PCBA if the reflow soldering process is using rail conveyors for the production.	If there is any bending or deformation to the PCBA board, this might causes the PCBA to collide into one another during the unloading process.
4	Before the PCBA is going through the reflow-soldering process, the production operators must check by eyesight to see if there are positional offset to the module, because it will be difficult to readjust after the module has gone through reflow-soldering process.	The operators must check by eyesight and readjust the position before reflow-soldering process.	If the operator is planning to readjust the module position, please do not touch the patch antenna while the module is hot in order to prevent rotational offset between the patch antenna and module

Note: References to patch antenna is referred to GPS modules with integrated Patch-on-top antennas (PA/Gms Module Series), and may not be applicable to all GPS modules.

	Details	Suggestions	Notes
5	Before handling the PCBA, they must be cooled to 35°C or below after they have gone through the reflow-soldering process, in order to prevent positional shift that might occur when the module is still hot.	<ol style="list-style-type: none"> 1. Can use electric fans behind the Reflow machine to cool them down. 2. Cooling the PCBA can prevent the module from shifting due to fluid effect. 	It is very easy to cause positional offset to the module and its patch antenna when handling the PCBA under high temperature.
6	<ol style="list-style-type: none"> 1. When separating the PCBA panel into individual pieces using the V-Cut process, special attentions are needed to ensure there are sufficient gap between patch antennas so the patch antennas are not in contact with one another. 2. If V-Cut process is not available and the pieces must be separated manually, please make sure the operators are not using excess force which may cause rotational offset to the patch antennas. 	<ol style="list-style-type: none"> 1. The blade and the patch antenna must have a distance gap greater than 0.6mm. 2. Do not use patch antenna as the leverage point when separating the panels by hand. 	<ol style="list-style-type: none"> 1. Test must be performed first to determine if V-Cut process is going to be used. There must be enough space to ensure the blade and patch antenna do not touch one another. 2. An uneven amount of manual force applied to the separation will likely to cause positional shift in patch antenna and module.
7	When separating panel into individual pieces during latter half of the production process, special attentions are needed to ensure the patch antennas do not come in contact with one another in order to prevent chipped corners or positional shifts.	Use tray to separate individual pieces.	It is possible to chip corner and/or cause a shift in position if patch antennas come in contact with each other.

Note: References to patch antenna is referred to GPS modules with integrated Patch-on-top antennas (PA/Gms Module Series), and may not be applicable to all GPS modules.

Other Cautionary Notes on Reflow-Soldering Process:

1. Module must be pre-baked **before** going through SMT solder reflow process.
2. The usage of solder paste should follow “first in first out” principle. Opened solder paste needs to be monitored and recorded in a timely fashion (can refer to IPQC for related documentation and examples).
3. Temperature and humidity must be controlled in SMT production line and storage area. Temperature of 23°C, 60±5% RH humidity is recommended. (please refer to IPQC for related documentation and examples)
4. When performing solder paste printing, please notice if the amount of solder paste is in excess or insufficient, as both conditions may lead to defects such as electrical shortage, empty solder and etc.
5. Make sure the vacuum mouthpiece is able to bear the weight of the GPS module to prevent positional shift during the loading process.
6. Before the PCBA is going through the reflow-soldering process, the operators should check by eyesight to see if there are positional offset to the module.
7. The reflow temperature and its profile data must be measured before the SMT process and match the levels and guidelines set by IPQC.
8. If SMT protection line is running a double-sided process for PCBA, please process GPS module during the second pass only to avoid repeated reflow exposures of the GPS module. Please contact GlobalTop beforehand if you must process GPS module during the 1st pass of double-side process.

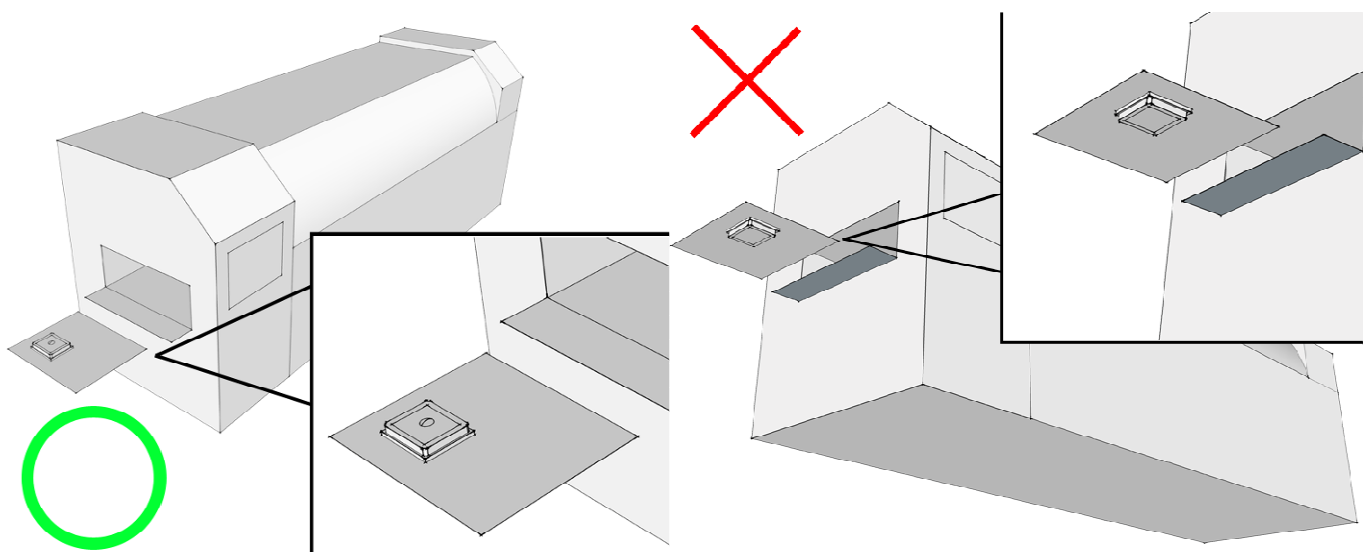

Figure 6.2: Place GPS module right-side up when running reflow-solder process, do not invert.

9. Module must be pre-baked **before** going through SMT solder reflow process.
10. The usage of solder paste should follow “first in first out” principle. Opened solder paste needs to be monitored and recorded in a timely fashion (can refer to IPQC for related documentation and examples).
11. Temperature and humidity must be controlled in SMT production line and storage area. Temperature of 23°C, 60±5% RH humidity is recommended. (please refer to IPQC for related documentation and examples)
12. When performing solder paste printing, please notice if the amount of solder paste is in excess or insufficient, as both conditions may lead to defects such as electrical shortage, empty solder and etc.
13. The reflow temperature and its profile data must be measured before the SMT process and match the levels and guidelines set by IPQC.

6.2 Manual Soldering

Soldering iron:

Bit Temperature: Under 380°C Time: Under 3 sec.

Notes:

1. Please do not directly touch the soldering pads on the surface of the PCB board, in order to prevent further oxidation
2. The solder paste must be defrosted to room temperature before use so it can return to its optimal working temperature. The time required for this procedure is unique and dependent on the properties of the solder paste used.
3. The steel plate must be properly assessed before and after use, so its measurement stays strictly within the specification set by SOP.
4. Please watch out for the spacing between soldering joint, as excess solder may cause electrical shortage
5. Please exercise with caution and do not use extensive amount of flux due to possible siphon effects on neighboring components, which may lead to electrical shortage.
6. Please do not use the heat gun for long periods of time when removing the shielding or inner components of the GPS module, as it is very likely to cause a shift to the inner components and will leads to electrical shortage.



7. Contact Information

GlobalTop Technology Inc.

Address: No.16 Nan-ke 9rd Road Science-based Industrial Park, Tainan 741, Taiwan

Tel: +886-6-5051268

Fax: +886-6-5053381

Website: www.gtop-tech.com

Email: sales@gtop-tech.com