

HC-08 and CC41-A is the copycat company copied behavior on HM-10.

If you buy a fake, please apply for a refund guarantee your legitimate rights and interests



JNHuaMao Technology Company

Bluetooth 4.0 BLE module

Datasheet

- 2 Professional bluetooth products suppliers.
- 2 Remote control module provider
- 2 data transmission module provider
- 2 PIO state acquisition module provider
- 2 Customizable bluetooth module and bluetooth solutions
- 2 Jinan high and new technology enterprise
- 2 SIG members

Address: D-4020, Qilu soft zone Jinan city, Shandong, China

Telephone: (86) 0531-85117999

WebSite: <http://www.jnhuamao.cn>

WebSite: <http://www.huamaosoft.com>

Mail: webmaster@jnhuamao.cn

**The most complete, most convenient, the most stable of
Bluetooth data transmission, remote control, PIO
acquisition module**

---- Master and slave role in one

---- Remote control without other MCU

---- The PIO data acquisition without other MCU

13. Product parameters

- Ø BT Version: Bluetooth Specification V4.0 BLE
- Ø Send and receive no bytes limit.
- Ø Working frequency: 2.4GHz ISM band
- Ø Modulation method: GFSK(Gaussian Frequency Shift Keying)
- Ø RF Power: -23dbm, -6dbm, 0dbm, 6dbm, can modify through AT Command AT+POWE.
- Ø Speed: Asynchronous: 1-6K Bytes
Synchronous: 1-6K Bytes
- Ø Security: Authentication and encryption
- Ø Service: Central & Peripheral UUID FFE0,FFE1
- Ø Power: +3.3VDC 50mA
- Ø Long range: Open space have 100 Meters with iphone4s
- Ø Power: In sleep mode 60uA~1.5mA, Active mode 8.5mA.
- Ø Working temperature:-5 ~ +65 Centigrade
- Ø Size: HM-10 26.9mm x 13mm x 2.2 mm; HM-11 18*13.5*2.2mm

2. Product overview

Thanks for you choose our products. If you want to know more, www.jnhuamao.cn can help you (Videos, New version datasheet, Module work flow, project Codes, etc.)

HM Bluetooth module use CSR BlueCore or TI CC2540, Master and slave roles in one, transmission version and remote control version and PIO state acquisition functions in one, Support the AT command modify module parameters, Convenient and flexible.

Transmission version can be used to transmit data between two Bluetooth devices.

Remote Control version can be used to Control PIO ports output high or low level without any other MCU.

The PIO state acquisition version can be used to acquisition PIO ports state without any other MUC. (Only support Bluetooth V2.1)

HM-01, HM-02, HM-03, HM-04, HM-05, HM-06, HM-07, HM-08, HM-09 is Bluetooth V2.1 version. Use CSR Chip.

HM-10, HM-11, HM-12 is Bluetooth V4.0 BLE version. Use TI Chip.

HM-01, HM-02, HM-09, HM-10 have same size and same pins.

HM-05, HM-06, HM-07, HM-11 have same size and same pins.















3. Product model

Models	VDD	Size(mm)	Flash	Chip	BT Version
HM-01	3.3V	26.9*13*2.2	8M	BC417143	V2.1+EDR
HM-02	2.5-3.7V	26.9*13*2.2	6M	BC3/BC4	V2.1
HM-03	2.5-3.7V	27.4*12.5*4.3	6M	BC3/BC4	V2.1
HM-04	3.3V	Not for sale			
HM-05	2.5-3.7V	13.5*18.5*2.3	6M	BC3/BC4	V2.1
HM-06	2.5-3.7V	13.5*18.5*2.3	6M	BC3/BC4	V2.1
HM-07	2.5-3.7V	13.5*18.5*2.3	8M		V2.1+EDR
HM-08	3.3V	26.9*13*2.5	8M	Class 1	V2.1+EDR
HM-09	2.5-3.7V	26.9*13*2.2	8M		V2.1+EDR
HM-10	2-3.7V	26.9*13*2.2	256Kb	CC2540/1	V4.0 BLE
HM-11	2.5-3.7V	13.5*18.5*2.2	256Kb	CC2540/1	V4.0 BLE
HM-12	2.7~3.7V	26.9*13*2.2	64KB	CSR	Dual mode
HM-13	2.7~3.7V	13.5*18.5*2.2	64KB	CSR	Dual mode
HM-15	5V	65*32*16	256KB	CC2540	V4.0 BLE

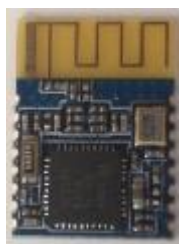
4. Product certificate

Products have FCC-ID, CE, RoHS. You can download certification from www.jnhuamao.cn or www.huamaosoft.com

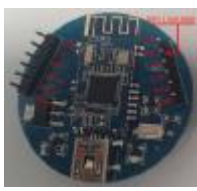
5. Product pictures

			Not for sale	
HM-01 BT 2.1	HM-02 BT 2.1	HM-03 BT 2.1	HM-04 BT 2.1	HM-05 BT 2.1
				
HM-06 BT 2.1	HM-07 BT 2.1	HM-09 BT 2.1	HM-10 BLE 4.0	HM-11 BLE 4.0
				
HM-12 Dual mode	HM-13 Dual mode	HM-15 BLE USB Dongle	HMSensor	iBeacon

6. Product technical specifications

This document only include Bluetooth BLE 4.0 document, You can goto http://www.inhuamao.cn/bluetooth_en.rar get Bluetooth V2.1 version datasheet. That document include: HM-01, HM-02, HM-03, HM-04, HM-05, HM-06, HM-07, HM-08, HM-09.

6.1 HM-10 Schematic

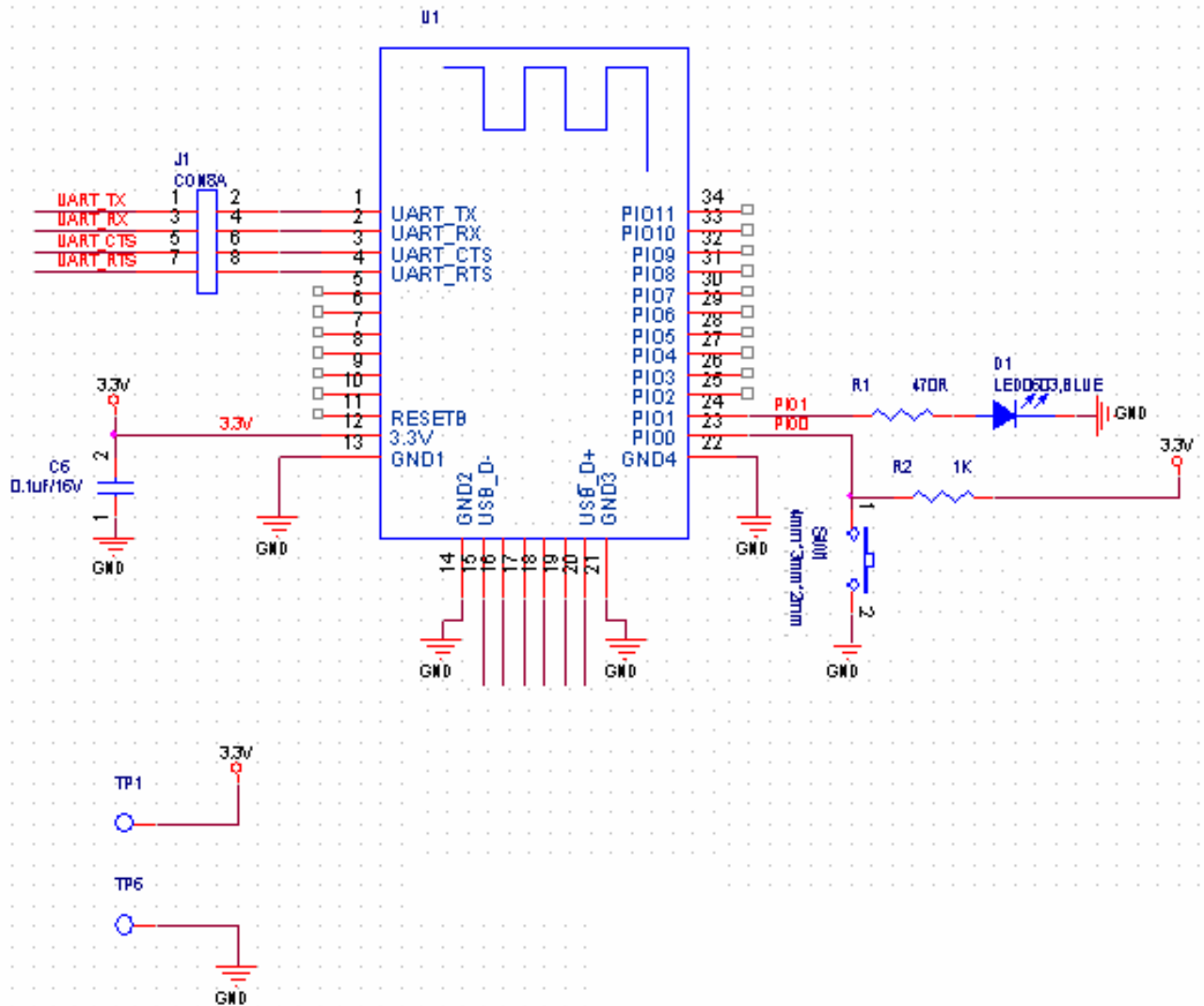

6.2 HM-10 Size

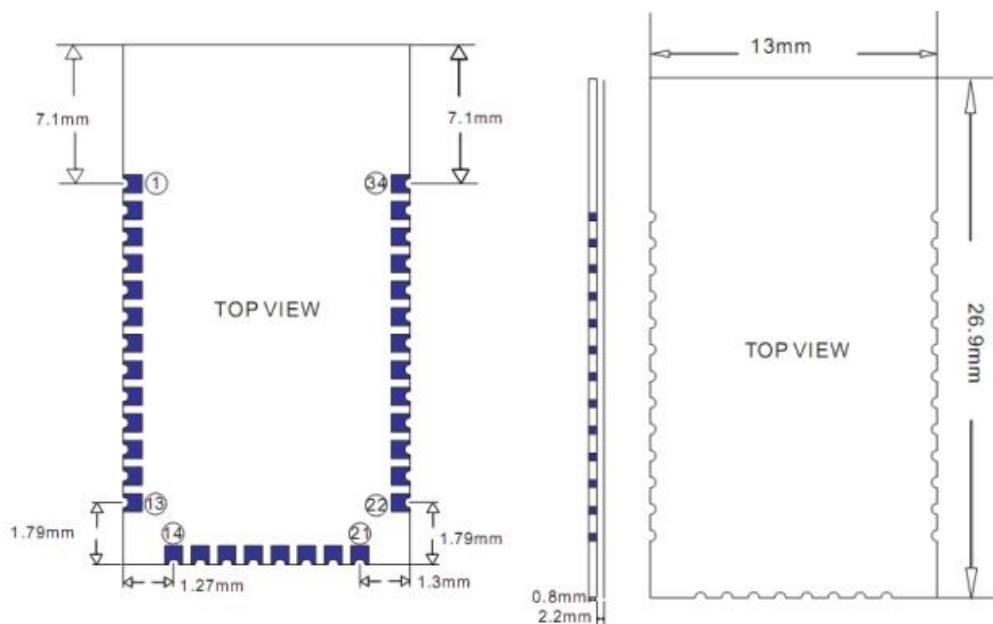

6.3 HM-10 package information

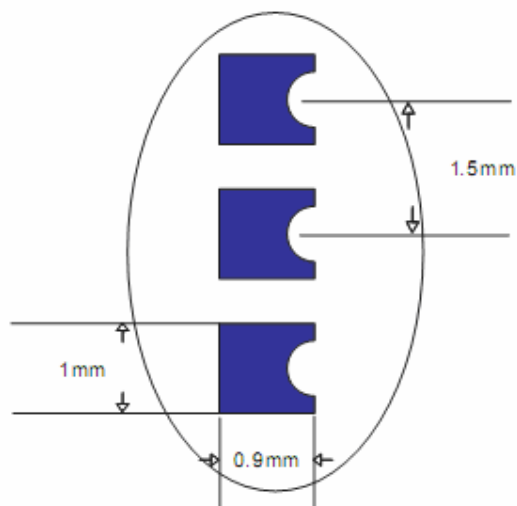

6.4 HM-10 Device Terminal Functions

No	Name	Description	CC254X
1	UART_TX	UART interface	P1_6
2	UART_RX	UART interface	P1_7
3	UART_CTS	UART interface	P1_4

4	UART_RTS	UART interface	P1_5
5	NC	NC	
6	NC	NC	
7	NC	NC	P2_2
8	NC	NC	P2_1
9	NC	NC	P2_0
10	NC	NC	
11	RESETB	Reset if low >100ms.	RESET_N
12	VCC	3.3V	
13	GND	Ground	
14	GND	Ground	
15	USB_D-	USB interface	PIN3
16	NC	NC	
17	NC	NC	
18	NC	NC	
19	NC	NC	
20	UB_D+	USB interface	PIN2
21	GND	Ground	GND
22	GND	Ground	GND
23	PIO0	System Key	P1_3
24	PIO1	System LED	P1_2
25	PIO2	input/output pin. PWM output	P1_1
26	PIO3	input/output pin/ADC	P1_0
27	PIO4	input/output pin/ADC	P0_7
28	PIO5	input/output pin/ADC	P0_6
29	PIO6	input/output pin/ADC	P0_5
30	PIO7	input/output pin/ADC	P0_4
31	PIO8	input/output pin/ADC	P0_3
32	PIO9	input/output pin/ADC	P0_2

33	PIO10	input/output pin/ADC	P0_1
34	PIO11	input/output pin/ ADC/DS18B20/DHT11	P0_0

6.5 HM-11 Size

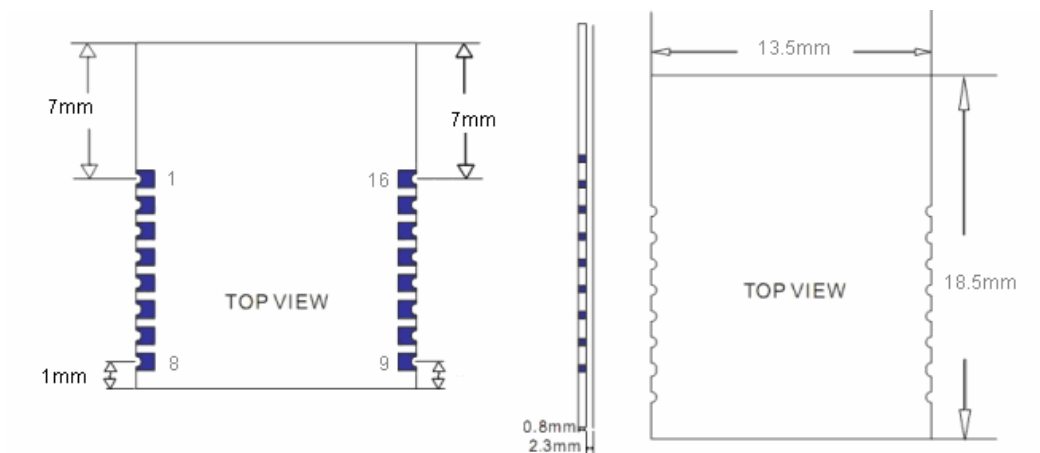

6.6 HM-11 Package information

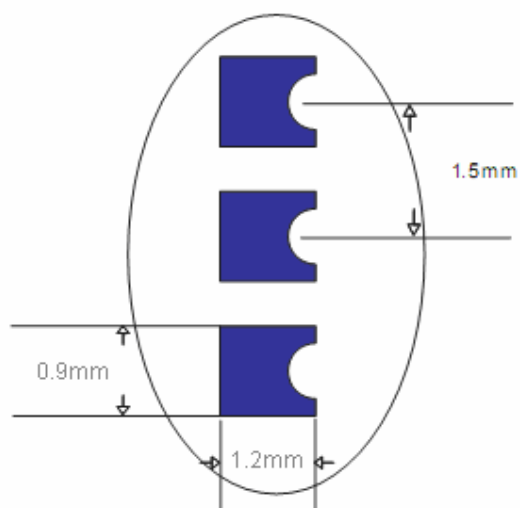

6.7 HM-11 Device Terminal Functions

No	Name	Description	CC254X
1	UART_RTS	UART interface	P1_5

2	UART_TX	UART interface	P1_6
3	UART_CTS	UART interface	P1_4
4	UART_RX	UART interface	P1_7
5	NC	NC	P2_1
6	NC	NC	P2_2
7	NC	NC	PIN2
8	NC	NC	PIN3
9	VCC	V3.3	VCC
10	NC	NC or VCC	
11	RESETB	Reset if low <100ms	RESET_N
12	GND	Ground	GND
13	PIO3	input/output pin	P1_1
14	PIO2	input/output pin/PWM	P1_0
15	PIO1	System LED	P0_7
16	PIO0	System KEY	P0_6

6.8 HM-15

HM-15 is based HM-10, a real USB interface.

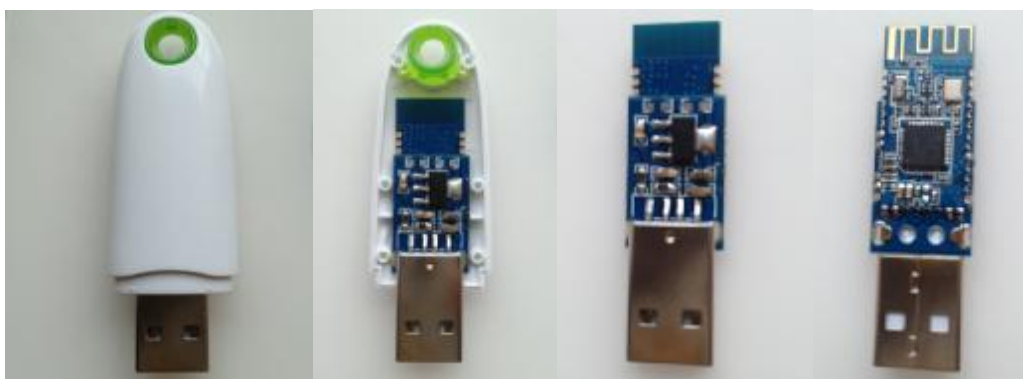

6.9 HM-Sensor

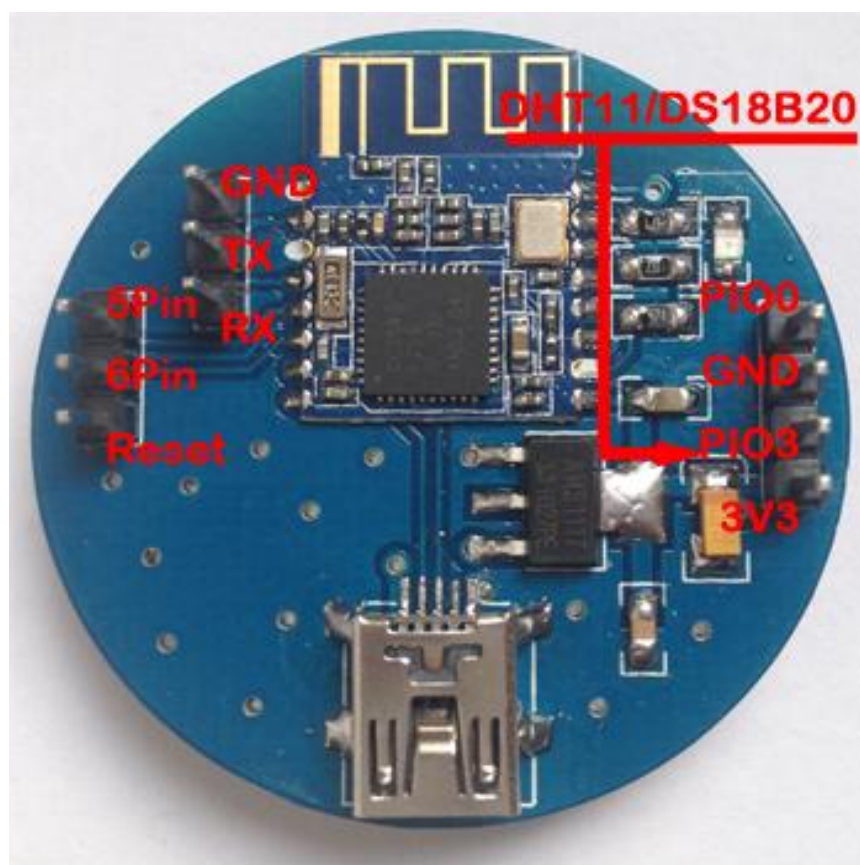
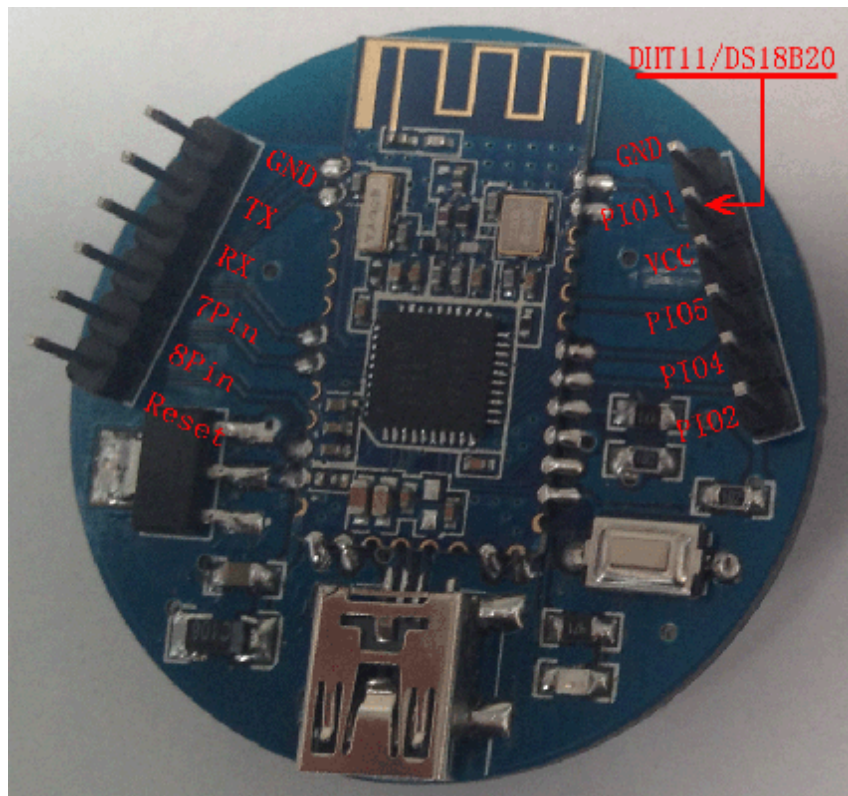

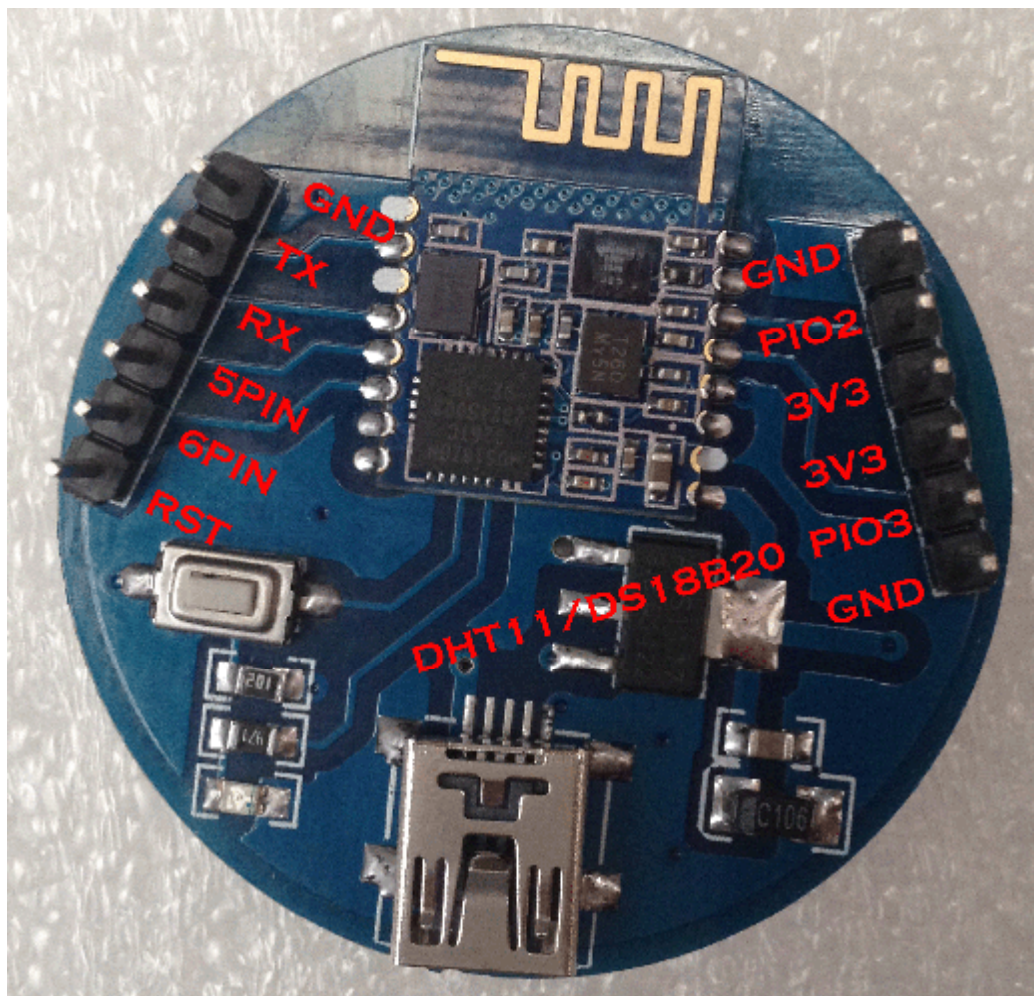

7. System function

How to wake up module from sleep mode?

There are two ways to wake up module from sleep mode.

7.1 Send "I am iron man, I am iron man, I am iron man I am iron....." string.

Yes, that is a joke, in sleep mode, you can send a long string (Length > 80 or more), that string can made module wake up, and you will receive "OK+WAKE" string through UART. That string can't include any AT commands.

7.2 Long press system KEY ≥ 1000 ms.

After wake up module, you can send and receive AT commands.

How to let module into sleep mode?

In discoverable mode, send "AT+SLEEP" string through UART, if all is okay, module will return "OK+SLEEP" string and into sleep mode.

System advert packet

In iOS cant get model MAC address directly. So we put MAC address information into advert packet.

You can use CBAvertisementDataManufactureDataKey property to get it, string format like follow:

0x48, 0x4D, 0xB4, 0x99, 0x4C, 0xXX, 0xXX, 0xXX

0x48 and 0x4D is "HM" string.

0xB4: 0x99: 0x4C: 0xXX: 0xXX: 0xXX is BLE MAC Address.

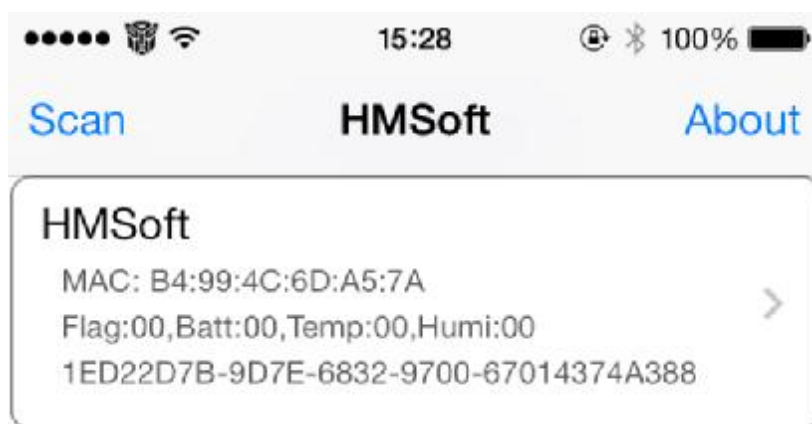

System KEY function (PIO0)

Press if Low > 1000ms:

7.3.1 If Module is in sleep mode

Module will wake up immediately, if AT+NOTI value is “1”, module will send “OK+WAKE” string through UART.

7.3.2 If Module has already connected to remote device

Module will disconnect from remote device.

7.3.3 If Module is standby mode

Module will reset to default configuration. Then restart.

System LED function (PIO1)

In sleep mode, LED has turned off.

If AT+PIO10 is setup

Unconnected status: Output High 500 ms, Low 500 ms

Connected status: Output High

If AT+PIO11 is setup

Unconnected status: Output Low.

Connected status: Output High.

System work Mode

A) Mode 0(Transmission mode):

When not connected, through the AT command configuration module, connection, only for serial data transmission.

B) Mode 1(PIO acquisition mode):

When not connected, through the AT command configuration module, connection, a) serial data transmission. b) Control of the PIO2,3 output state(HM-11 has none). c) The acquisition of PIO4 ~ 11 input state(HM-11 only PIO2,3).

C) Mode 2(Remote control mode):

When not connected, through the AT command configuration module, connection, a) serial data transmission. b) Control of the PIO2~11 output state(HM-11 only PIO2,3).

8 AT Commands

Factory default setting:

Name: HMSoft; Baud: 9600, N, 8, 1; Pin code: 000000; Peripheral Role; transmit mode.

AT Command format:

Uppercase AT command format. string format, without any other symbol. (e.g. \r or \n).

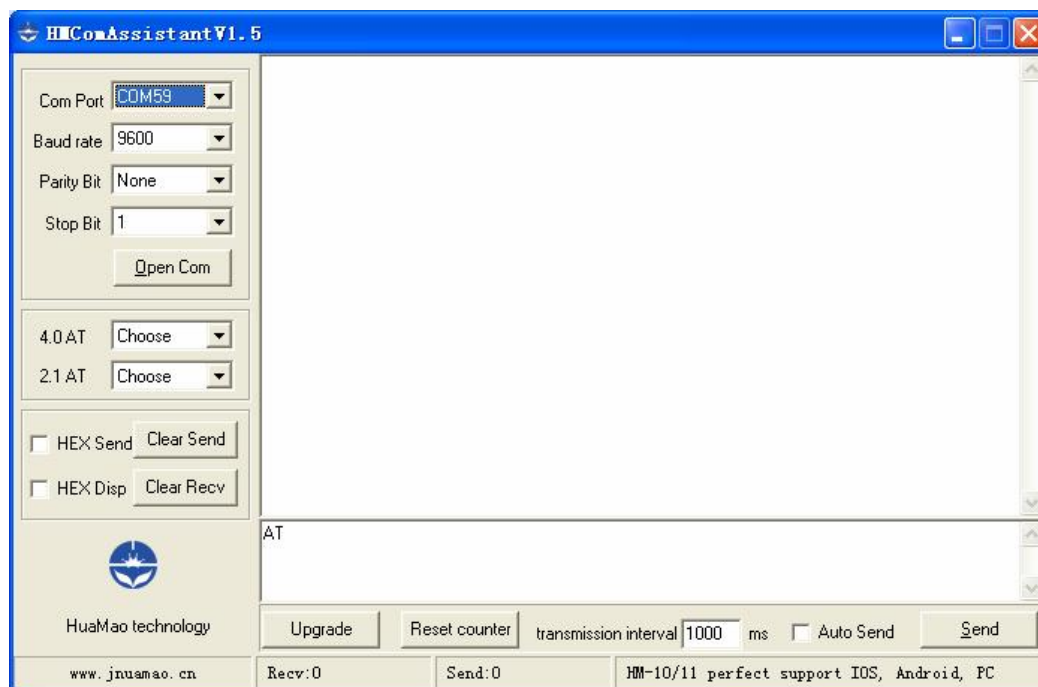

On Transmit version: Only accept AT Command from UART interface when Bluetooth device is not connected with remote device.

On Remote version: Can accept AT Command from UART interface when Bluetooth Device is not connected with remote device, Also can accept AT Command from remote Bluetooth device when connected that.

On PIO collection version: Only accept AT Command from UART interface when Bluetooth device is not connected with remote device.

Bluetooth V2.1 version Command is not here, please download datasheet from http://www.jnhuamao.cn/Bluetooth_en.rar

1. Test Command

Send	Receive	Parameter
AT	OK OK+LOST	None

If Module is not connected to remote device will receive: "OK"

If Module has connected, module will disconnected from remote device, if "AT + NOTI" is setup to 1, will receive: "OK+LOST"

2. Query module address

Send	Receive	Parameter
AT+ADC[para1]?	OK+GET:0.00	Para1: 3~B map to PIO3~PIOB

HM-11 has no this function.

Added since V526.

3. Query module address

Send	Receive	Parameter
AT+ADDR?	OK+ADDR:MAC Address	None

3. Query/Set Advertising interval

Send	Receive	Parameter
AT+ADVI?	OK+ Get:[Para]	None
AT+ADVI[Para]	OK+ Set:[Para]	Para: 0 ~ F 0: 100ms 1: 152.5 ms 2: 211.25 ms 3: 318.75 ms 4: 417.5 ms 5: 546.25 ms 6: 760 ms 7: 852.5 ms 8: 1022.5 ms 9: 1285 ms

		A: 2000ms B: 3000ms C: 4000ms D: 5000ms E: 6000ms F: 7000ms Default: 9 HMSoft Default: 0 HMSensor Default: 9
--	--	--

The maximum 1285ms recommendations form the IOS system. That is to say, 1285ms is apple allowed, but in response to scan and connected all the time will be long.

This command is added since V517 version.

V522 allow max value F.

4. Query/Set Advertising Type

Send	Receive	Parameter
AT+ADTY?	OK+ Get:[Para]	None
AT+ADTY[Para]	OK+ Set:[Para]	Para: 0 ~ 3 0: Advertising ScanResponse, Connectable 1: Only allow last device connect in 1.28 seconds 2: Only allow Advertising and ScanResponse. 3: Only allow Advertising Default: 0

Added since V519

5. Query/Set ANCS switch

Send	Receive	Parameter
AT+ANCS?	OK+ Get:[Para]	None
AT+ANCS[Para]	OK+ Set:[Para]	Para: 0 ~ 1 0: Off 1: On Default: 0

Note1: This command added in V524.

Note2: Please send AT+RESET to restart module if you set value 1.

Note3: Must execute AT+TYPE3 first.

6. Query/Set whitelist switch

Send	Receive	Parameter
AT+ALLO?	OK+ Get:[Para]	None
AT+ALLO[Para]	OK+ Set:[Para]	Para: 0 ~ 1 0: Off 1: On Default: 0

Note1: This command added in V523.

Note2: WhiteList allow three mac address link to module. Please use AT+AD command set whitelist mac address.

7. Query/Set whitelist mac address

Send	Receive	Parameter
AT+AD[para1]??	OK+ Get:[Para2]	None
AT+ALLO[Para1][Para2]	OK+ Set:[Para2]	Para1: 1, 2, 3 Para2: MAC address Para1 default: 0

Note1: This command added in V523.

E.g.

Send AT+ID1001122334455

Recv OK+Set:001122334455

8. Query/Set Module pin output state, After power supplied

Send	Receive	Parameter
AT+BEFC?	OK+ Get:[Para]	None
AT+BEFC[Para]	OK+ Set:[Para]	Para: 000~ 3FF Default: 000

This command added in V527.

3FF == 001111111111, left to right side is map to PIO0~PIOB, PIO0 and Plo1 is used by system. Only Pio2~PIOB pins is available.

e.g. Set PIO2~PIOB all output high after power supplied.

Send: AT+BEFC3FF

Recv:OK+Set:3FF

When next time power on, module PIO2~PIOB will output high.

Note: Query PIO pins current state please use AT+PIO?? Command.

Note: Please don't use this command when "AT+MODE1" is setup.

9. Query/Set Module pin output state, After connection is established

Send	Receive	Parameter
AT+AFTC?	OK+ Get:[Para]	None
AT+AFTC[Para]	OK+ Set:[Para]	Para: 000~ 3FF Default: 000

This command added in V527.

3FF == 001111111111, Left to right side is map to PIO0~PIOB, PIO0 and Plo1 is used by system. Only Pio2~PIOB pins is available.

e.g. Set PIO2~PIOB all output high when connection is established.

Send: AT+AFTC3FF

Recv: OK+Set:3FF

When Bluetooth connection is established, module PIO2~PIOB will output high.

Note: Query PIO pins current state please use "AT+PIO??" command.

Note: Please don't use this command when "AT+MODE1" is setup.

10. Query/Set battery monitor switch

Send	Receive	Parameter
AT+BATC?	OK+ Get:[Para]	None
AT+BATC[Para]	OK+ Set:[Para]	Para: 0 ~ 1 0: Off 1: On Default: 0

This command added in V520

11. Query battery information

Send	Receive	Parameter
AT+BATT?	OK+BATT:[Para]	Para: 000~100

There has three ways to get battery information:

- a. Before establishing a connection, Send “AT+BATT?” through UART.
- b. After established a connection, In Mode 1 or 2, remote side send “AT+BATT?”

Battery information has included in scan response data package, one hour update once. You can use Android or IOS discovery module, when module has been discovered, you can get it from scan result array.

Data format is 0x02, 0x16, 0x00, 0xB0, [FLAG], [temperature], [humidity], [battery].

Android:

Included in OnLeScan function result array, you can see it direct.

```
private BluetoothAdapter.LeScanCallback mLeScanCallback = new BluetoothAdapter.LeScanCallback() {

    @Override

    public void onLeScan(final BluetoothDevice device, int rssi,

        byte[] scanRecord) {

        .....<Other code>.....

        String sBatt = ""; //Battery

        String sTemp = ""; //Temperature
    }
}
```

```

String sHumi = ""; //Humidity

for(int i = 0; i < scanRecord.length; i++)

{

    if(i + 7 < scanRecord.length)

    {

        //Since V522

        if(scanRecord[i] == 0x07 && scanRecord[i + 1] == 0x16

            && scanRecord[i + 2] == 0x00 && scanRecord[i + 3] == 0xB0)

        {

            if(scanRecord[i + 7] > 0)

                sBatt = String.valueOf(scanRecord[i + 7]);

            if(scanRecord[i + 5] > 0)

                sTemp = String.valueOf(scanRecord[i + 5]);

            if(scanRecord[i + 6] > 0)

                sHumi = String.valueOf(scanRecord[i + 6]);

        }

    }

}

.....<Other code>.....

}

};

```

iOS:

- c. Included in LeScan function result NSDictionary struct, service id is 0xB000.

12. Query/Set Bit format

Send	Receive	Parameter
AT+BIT7?	OK+Get:[para1]	Para1: bit7 switch.

AT+BIT7[para1]	OK+Set:[para1]	0-----Not compatible 1-----Compatible Default: 0
----------------	----------------	--

This command is used only for compatible uses 7 data bits, 2 stop bit device.

13. Query/Set baud rate

Send	Receive	Parameter
AT+BAUD?	OK+Get:[para1]	Para1: Baud rate No.
AT+BAUD[para1]	OK+Set:[para1]	0-----9600 1-----19200 2-----38400 3-----57600 4-----115200 5-----4800 6-----2400 7-----1200 8-----230400 Default: 0(9600)

e.g.

Query baud:

Send: AT+BAUD?

Receive: OK+Get:0

Setup baud:

Send: AT+BAUD1

Receive: OK+Set:1

Note: If setup to Value 7, After next power on, module will not support any AT Commands, until PIO0 is pressed, Module will change Baud to 9600.

14. Query/Set Characteristic

Send	Receive	Parameter
AT+CHAR?	OK+Get:[para1]	Para1: 0x0001~0xFFFE

AT+CHAR[para1]	OK+Set:[para1]	Default: 0xFFE1
----------------	----------------	-----------------

e.g. change characteristic value to 0xAAA0

Send: AT+CHAR0xAAA0

Recv: OK+Set:0xAAA0

15. Clear Last Connected device address

Send	Receive	Parameter
AT+CLEAR	OK+CLEAR	None

Notice: Only Central role is used.

16. Try connect to last succeeded device

Send	Receive	Parameter
AT+CONNL	OK+CONN[Para1]	Para1: L, E, F, N L: Connecting E: Connect error F: Connect Fail N: No Address

Notice: Only Central role is used. Must set up AT+IMME1 and AT+ROLE1 first.

If remote device has already connected to other device or shut down, "OK+CONNF" will received after about 10 seconds.

17. Try connect an address

Send	Receive	Parameter
AT+CO[P0][P1]	OK+CO[P0][P0][P2]	P0: N, 1 N: Normal Address 1: Dual module Addr P1: Address Like: 0017EA090909 P2: A, E, F A: Connecting E: Connect error

		F: Connect Fail
--	--	-----------------

Notice: Only central role is used. Must set up AT+IMME1 and AT+ROLE1 first.

If remote device has already connected to other device or shut down, "OK+CONN" will received after about 10 Seconds.

e.g.

Try to connect an device which MAC address is 00:17:EA:09:09:09

Send: AT+CON0017EA090909

May receive a reply:

- OK+CONNA ===== Accept request, connecting
- OK+CONNE ===== Connect error
- OK+CONN ===== Connected, if AT+NOTI1 is setup
- OK+CONN ===== Connect Failed, After 10 seconds

18. Query PIO04~PIO11 input(output) state

Send	Receive	Parameter
AT+COL??	OK+ Col:[Para1]	Para1: 0x00~0xFF

Para1 is a byte, has 8 bits, bit 7 ~ bit 0 is map to the PIO4 ~ PIO11.

This command is added since V515 version.

19. Query/Set PIO collection rate

Send	Receive	Parameter
AT+CYC??	OK+ Get:[para1]	Para1: 00~99
AT+CYC[para1]	OK+ Set:[para1]	Unit: seconds Default: 10

In mode 1, when PIO state is change, module will send OK+Col:[xx] to UART or remote side. This command is set send interval.

This command is added since V515 version.

20. Start a device discovery scan

Send	Receive	Parameter
AT+DISC?	OK+DIS[P0][P1]	P0: C,0, 1, 2

		<p>C: Common string</p> <p>0~2: Address type</p> <p>P1: S, E, [MAC String]</p> <p>S: Start discovery</p> <p>E: End discovery</p> <p>MAC String :</p> <p>Device MAC string</p>
--	--	---

Please set AT+ROLE1 and AT+IMME1 first.

e.g.

Send: AT+DISC?

Recv: OK+DISCS

Recv: OK+DIS[P0]:123456789012 (discovered device address information)

If AT+SHOW1 is setup, you will receive then Name information as follow

Recv: OK+NAME: xxx

After send Name value, will send two extra “\r\n” value ASCII byte

Recv: OK+DIS[P0]:234567890123

Recv: OK+NAME: xxx

After send Name value, will send two extra “\r\n” value ASCII byte

.....(Before V535 max results is 6, Since V535 not limit)

Recv: OK+DISCE

Connect use array index:

Connect to a discovered device: AT+CONN0, AT+CONN1.....AT+CONN5

Connect use MAC string: AT+CON[MAC String]

21. Connect to an Discovery device

Send	Receive	Parameter
AT+CONN[para1]	OK+CONN[para2]	<p>Para1: 0~5</p> <p>Para2: E, F, 0~5</p> <p>E: Link error</p> <p>F: Link failed</p>

		0~5: Try to connect
--	--	---------------------

This command is use after execute AT+DISC?

This command will clear all discovery data.

22. Query/Set iBeacon deploy mode

Send	Receive	Parameter
AT+DELO[para1]	OK+DELO[para1]	Para1: 1, 2 1: Allowed to broadcast and scanning 2: Only allow broadcast

After receive OK+DELO[para1], module will reset after 500ms.

This command will let module into non-connectable status until next power on.

23. Remove bond information

Send	Receive	Parameter
AT+ERASE	OK+ERASE	

Note: Added in V524 version.

24. Set advertising data FLAG byte

Send	Receive	Parameter
AT+FLAG[P1]	OK+ Set:[P1]	P1: 0~FF (one byte)

Note: This command added in V530. Please ref to AT+BATT? Command.

25. Query/Set filter of HM modules

Send	Receive	Parameter
AT+FILT?	OK+ Get:[para1]	Para1: 0, 1
AT+FILT[para1]	OK+ Set:[para1]	0: Will find all BLE modules 1: Only find HM Modules Default: 1

Note: This command is removed since V530

26. Query/Set flow control switch

Send	Receive	Parameter
AT+FIOW?	OK+ Get:[para1]	Para1: 0, 1

AT+FIOW[para1]	OK+ Set:[para1]	0: Off 1: On Default: 0
----------------	-----------------	-------------------------------

27. Query/Set module RX gain

Send	Receive	Parameter
AT+GAIN?	OK+ Get:[P1]	P1: 0, 1
AT+GAIN[P1]	OK+ Set:[P1]	0: No RX gain 1: Open RX gain Default: 0

Note: This command is added since V535

28. System Help Information

Send	Receive	Parameter
AT+HELP?	Help Information	None

29. Query/Set Module work type

Send	Receive	Parameter
AT+IMME?	OK+ Get:[para1]	Para1: 0, 1
AT+IMME[para1]	OK+ Set:[para1]	1: When module is powered on, only respond the AT Command, don't do anything. Until AT + START, AT+CON, AT+CONNL commands is received. 0: When power on, work immediately Default: 0

This command is only used for Central role.

30. Query/Set Module iBeacon switch

Send	Receive	Parameter
AT+IBEA?	OK+Get:[para1]	Para1: 0, 1

AT+IBEA[para1]	OK+Set:[para1]	0: Turn off iBeacon 1: Turn on iBeacon Default: 0
----------------	----------------	---

iBeacon UUID is: 74278BDA-B644-4520-8F0C-720EAF059935.

This command is added since V517 version.

31. Query/Set iBeacon UUID

Send	Receive	Parameter
AT+IBE0?	OK+Get:[para1]	Para1: 00000001~ FFFFFFFFE Default: 74278BDA
AT+IBE0[para1]	OK+Set:[para1]	

iBeacon UUID is: **74278BDA**-B644-4520-8F0C-720EAF059935.

This command can change red color string in iBeacon UUID.

This command is added since V520 version.

e.g.: Send: AT+IBE012345678 change iBeacon UUID red color string to “12345678”

32. Query/Set iBeacon UUID

Send	Receive	Parameter
AT+IBE1?	OK+Get:[para1]	Para1: 00000001~ FFFFFFFFE Default: B6444520
AT+IBE1[para1]	OK+Set:[para1]	

iBeacon UUID is: 74278BDA-**B644-4520**-8F0C-720EAF059935.

This command can change red color string in iBeacon UUID.

This command is added since V520 version.

e.g.: Send: AT+IBE112345678 change iBeacon UUID red color string to “12345678”

33. Query/Set iBeacon UUID

Send	Receive	Parameter
AT+IBE2?	OK+Get:[para1]	Para1: 00000001~ FFFFFFFFE
AT+IBE2[para1]	OK+Set:[para1]	

		Default: 8F0C720E
--	--	-------------------

iBeacon UUID is: 74278BDA-B644-4520-8F0C-720EAF059935.

This command can change red color string in iBeacon UUID.

This command is added since V520 version.

e.g.: Send: AT+IBE112345678 change iBeacon UUID red color string to "12345678"

34. Query/Set iBeacon UUID

Send	Receive	Parameter
AT+IBE3?	OK+Get:[para1]	Para1: 00000001~
AT+IBE3[para1]	OK+Set:[para1]	FFFFFFFE Default: AF059935

iBeacon UUID is: 74278BDA-B644-4520-8F0C-720EAF059935.

This command can change red color string in iBeacon UUID.

This command is added since V520 version.

e.g.: Send: AT+IBE112345678 change iBeacon UUID red color string to "12345678"

35. Query/Set Module iBeacon Marjor version

Send	Receive	Parameter
AT+MARJ?	OK+Get:[para1]	Para1: 0x0001, 0xFFFFE
AT+MARJ[para1]	OK+Set:[para1]	Default: 0xFFE0

E.g. Change marjor version to 0x0102

Send: AT+MARJ0x0102, if all is okay, module will send back OK+Set: 0x0102

This command is added since V517 version.

36. Query/Set Module iBeacon minor

Send	Receive	Parameter
AT+MINO?	OK+Get:[para1]	Para1: 0x0001, 0xFFFFE
AT+MINO[para1]	OK+Set:[para1]	Default: 0xFFE1

This command is added since V517 version.

37. Query/Set Module iBeacon Measured power

Send	Receive	Parameter
AT+MEAS?	OK+Get:[para1]	Para1: 0x0001, 0xFFFE
AT+MEAS[para1]	OK+Set:[para1]	Default: 0xFFE1

This command is added since V519 version.

38. Query/Set Module Work Mode

Send	Receive	Parameter
AT+MODE?	OK+Get:[para1]	Para1: 0, 1, 2
AT+MODE[para1]	OK+Set:[para1]	0: Transmission Mode 1: PIO collection Mode + Mode 0 2: Remote Control Mode + Mode 0 Default: 0

Mode 0:

Before establishing a connection, you can use the AT command configuration module through UART.

After established a connection, you can send data to remote side from each other.

Mode 1:

Before establishing a connection, you can use the AT command configuration module through UART.

After established a connection, you can send data to remote side. Remote side can do fellows:

Send AT command configuration module.

Collect PIO04 to the PIO11 pins input state of HM-10.

Collect PIO03 pins input state of HM-11.

Remote control PIO2, PIO3 pins output state of HM-10.

Remote control PIO2 pin output state of HM-11.

Send data to module UART port (not include any AT command and per package must less than 20 bytes).

Mode 2:

Before establishing a connection, you can use the AT command configuration module through UART.

After established a connection, you can send data to remote side. Remote side can do fellows:

Send AT command configuration module.

Remote control PIO2 to PIO11 pins output state of HM-10.

Remote control PIO2, PIO3 pins output state of HM-11.

Send data to module UART port (not include any AT command and per package must less than 20 bytes).

39. Query/Set Notify information

Send	Receive	Parameter
AT+NOTI?	OK+Get:[para1]	Para1: 0, 1
AT+NOTI[para1]	OK+Set:[para1]	0: Don't Notify 1: Notify Default: 0

If this value is set to 1, when link ESTABLISHED or LOSTED module will send OK+CONN or OK+LOST string through UART.

40. Query/Set notify mode

Send	Receive	Parameter
Q: AT+NOTP?	OK+ Get[P1]	P1: 0, 1; default: 0
Q: AT+NOTP[P1]	OK+ Set[P1]	0: without address 1: with address

This command must work with “AT+NOTI1”, if this switch is open, when the module connect to disconnect, the prompt string will include the remote address.

OK+CONN:001122334455 String “001122334455” is the MAC address

string

Added since V534

41. Query/Set Module name

Send	Receive	Parameter
AT+NAME ?	OK+NAME[para1]	Para1: module name, Max length is 12. Default: HMSoft
AT+NAME[para1]	OK+Set[para1]	

e.g.

change module name to bill_gates

Send: AT+NAMEbill_gates

Receive: OK+SetName:bill_gates

42. Query/Set output driver power

Send	Receive	Parameter
Query: AT+PCTL?	OK+Get:[para1]	None
Set: AT+PCTL[para1]	OK+Set:[para1]	Para1: 0,1 0:Normal power output 1:Max power output Default: 1

Noted: Added in V527

43. Query/Set Parity bit

Send	Receive	Parameter
Query: AT+PARI?	OK+Get:[para1]	None
Set: AT+PARI[para1]	OK+Set:[para1]	Para1: 0,1,2 0:None 1:EVEN 2:ODD Default: 0 (None)

44. Query/Set PIO1 output status (System LED)

Send	Receive	Parameter

AT+PIO1?	OK+Get:[para1]	Para1: 0, 1
AT+ PIO1 [para1]	OK+Set:[para1]	0: Unconnected Output 500ms High 500ms Low, Connected output High. 1: Unconnected output Low, Connected output High. Default: 0

45. Query/Set PIO pins output high or low (Only this time, when module next power on, this value is not be used)

Send	Receive	Parameter
AT+PIO[para1]?	OK+PIO:[para1][para2]	Para1: 2~B, ?
AT+PIO[para1][para2]	OK+PIO:[para1][para2]	Para2: 0, 1, ? HM-11 only has 4 pins. Para1 is which PIO pin you want to Query/Set Value: 2,3,4,5,6,7,8,9,A,B. Para2 is Query or setup value. "0" is low and "1" is high and "?" is query

e.g.

Query PIO2

Send: AT+PIO2?

Setup PIO2 output high

Send: AT+PIO21

Receive: OK+PIO21

HM-10 HMSensor version: para1 value is 2~A

HM-10 HMSoft version: para1 value is 2~B

HM-11 HMSensor version: para1 value is 2

HM-11 HMSoft version: para1 value is 2, 3

V525 added PIO2 PWM function, Para2 value is 0~9

0: output low

1: output high

2: output 100ms PWM

3: output 200ms PWM

.....

9: output 800ms PWM

V527 added AT+PIO?? Format query all pins output state.

46. Query/Set Pin Code

Send	Receive	Parameter
AT+PASS?	OK+Get:[para1]	Para1 is Pin Code, 000000~999999 Default: 000000
AT+PIN[para1]	OK+Set:[para1]	

e.g.

Query Pin Code

Send: AT+PIN?

Receive: OK+PIN:000000

Setup Pin Code 008888

Send: AT+PIN008888

Receive: OK+Set:008888

47. Query/Set Module Power

Send	Receive	Parameter
AT+POWE?	OK+Get:[para1]	None
AT+ POWE [para1]	OK+Set:[para1]	Para: 0 ~ 3 0: -23dbm 1: -6dbm

		2: 0dbm 3: 6dbm Default: 2
--	--	----------------------------------

48. Query/Set Module sleep type

Send	Receive	Parameter
AT+PWRM?	OK+Get:[para1]	None
AT+PWRM[para1]	OK+Set:[para1]	Para1: 0~1 0:Auto sleep 1:don't auto sleep Default: 1

Only support peripheral role.

49. Query/Set reliable advertising mode

Send	Receive	Parameter
AT+RELI?	OK+ Get:[para1]	Para1: 0, 1
AT+RELI[para1]	OK+ Set:[para1]	0: Normal advertising 1: Reliable advertising Default: 0

Note: This command is added since V530

50. Restore all setup value to factory setup

Send	Receive	Parameter
AT+RENEW	OK+RENEW	None

51. Restart module

Send	Receive	Parameter
AT+RESET	OK+RESET	None

52. Query/Set Master and Slaver Role

Send	Receive	Parameter
AT+ROLE?	OK+Get:[para1]	Para1: 0, 1
AT+ROLE[para1]	OK+Set:[para1]	0: Peripheral 1: Central

		Default: 0
--	--	------------

53. Query RSSI Value

Send	Receive	Parameter
AT+RSSI?	OK+RSSI:[para1]	None

Require: AT+MODE value > 0

This command only used by Remote device query when connected.

54. Query Last Connected Device Address

Send	Receive	Parameter
AT+RADD?	OK+RADD:MAC Address	None

55. Query/Set Module Sensor work interval

Send	Receive	Parameter
AT+RAT??	OK+Get:[para1]	Para1: 00~99
AT+RAT[para1]	OK+Set:[para1]	0:Save when connected 1:Don't Save Default: 0 Unit: minute

Note: This command is only use for HMSensor

56. Query/Set Stop bit

Send	Receive	Parameter
AT+STOP?	OK+Get:[para1]	None
AT+STOP[para1]	OK+Set:[para1]	Para1:0, 1 0: One stop bit 1: Two stop bit Default: 0 (One stop bit)

57. Work immediately

Send	Receive	Parameter
AT+START	OK+START	None

This command is only used when AT+IMME1 is setup.

58. Query Module into sleep mode

Send	Receive	Parameter
AT+SLEEP	OK+SLEEP	None

Only support Peripheral role.

59. Query/Set Module save connected address parameter

Send	Receive	Parameter
AT+SAVE?	OK+Get:[para1]	None
AT+SAVE[para1]	OK+Set:[para1]	Para1: 0~1 0:Save when connected 1:Don't Save Default: 0

60. Query/Set sensor type on module PIO11(HM-11 is PIO3)

Send	Receive	Parameter
AT+SENS?	OK+Get:[para1]	Para1: 0, 1, 2
AT+SENS[para1]	OK+Set:[para1]	0: None 1: DHT11 2: DS18B20 Default: 0

Note: This command is use for HMSensor.

61. Query/Set discovery parameter

Send	Receive	Parameter
AT+SHOW?	OK+Get:[para1]	None
AT+SHOW[para1]	OK+Set:[para1]	Para1: 0~1 0:Don't show name 1:Show name Default: 0

Please execute AT+FILT0 first.

If AT+SHOW1 is setup, AT+DISC? Command will show you name information included into scan result package.

62. Query/Set Module Sensor Temperature and humidity(if has a sensor)

Send	Receive	Parameter
AT+TEHU?	OK+Get:[para1][para2]	Para1: 000~120 Para2: 000~100

Note: This command is use for HMSensor.

This value is added into scan response data package.

Data format is 0x02, 0x16, 0x00, 0xB0, [reserved], [temperature], [humidity], [battery].

Android:

Included in OnLeScan function result array, you can see it direct.

iOS:

Included in LeScan function result NSDictionary struct, service id is 0xB000.

63. Query DS18B20 Sensor or IC temperature

Send	Receive	Parameter
AT+TEMP?	OK+Get:[para1]	Para1: 000.000~255.000

Note1: if not setup AT+SENS value, will get IC temperature.

Note2: Added in V523 version, Modified at V526.

64. Query/Set module connect remote device timeout value

Send	Receive	Parameter
AT+TCON?	OK+TCON:[para1]	None
AT+TCON[para1]	OK+Set:[para1]	Para1 is timeout value. when time is up module will not connect this address anymore, then enter search mode. Para1 allowed value: 000000~999999 Unit is ms.

		Default: 000000 Connect forever
--	--	------------------------------------

This value is only used for Central Role, when module has Last Connected address.

65. Query/Set Module Bond Mode

Send	Receive	Parameter
AT+TYPE?	OK+Get:[para1]	None
AT+TYPE[para1]	OK+Set:[para1]	Para1: 0~2 0:Not need PIN Code 1:Auth not need PIN 2:Auth with PIN 3:Auth and bond Default: 0

Important: If your module version is less than V515, please don't use this command. Under android 4.3 AT+TYPE1 is same to AT+TYPE2.

Note1: Value 3 is added in V524.

66. Query/Set service UUID

Send	Receive	Parameter
AT+UUID?	OK+Get:[para1]	Para1: 0x0001~0xFFFFE
AT+UUID[para1]	OK+Set:[para1]	Default: 0xFFE0

e.g. Change UUID value to 0xAAA0

Send: AT+UUID0xAAA0

Recv: OK+Set:0xAAA0

67. Query/Set UART sleep type

Send	Receive	Parameter
AT+UART?	OK+Get:[para1]	Para1: 0~1
AT+UART[para1]	OK+Set:[para1]	0: When module into sleep mode, you can wake up module through

		UART. 1: When module into sleep mode, shutdown UART too. Default: 0xFFE0
--	--	--

Note: This command is only use for HMSensor.

68. Query Software Version

Send	Receive	Parameter
AT+VERR? AT+VERS?	Version Information	None

Resource:

Bluetooth Module 2.1 datasheet:

http://www.jnhuamao.cn/Bluetooth_en.zip

Bluetooth Module 4.0 datasheet:

http://www.jnhuamao.cn/Bluetooth40_en.zip

Bluetooth Module 4.0 USB Dongle

http://www.jnhuamao.cn/HMDongle40_en.zip

Bluetooth 2.1 Com Assistant for android:

<http://www.jnhuamao.cn/HMComAssistant.rar>

Bluetooth 4.0 Com Assistant for android 4.3:

<http://www.jnhuamao.cn/HMBLEComAssistant.rar>

Bluetooth 4.0 IOS Code:

http://www.jnhuamao.cn/HMSoft_iso7.zip

http://www.jnhuamao.cn/HMSoft_iso7.zip