

arbotiX robocontroller
V0.9 for Rev A Boards
User Manual

Introduction

The arbotiX robocontroller is a high-end AVR-based robot controller. This manual is an introduction to the physical board, and how to connect devices to it. For documentation on software setup and the arbotiX libraries, see <http://arbotix.googlecode.com>.

Required Accessories:

- FTDI serial cable or In-System Programmer to load code onto your arbotiX.
- A power supply.

Optional accessories:

- XBEE Radios
- Headers for prototyping area

General overview of components and connections:

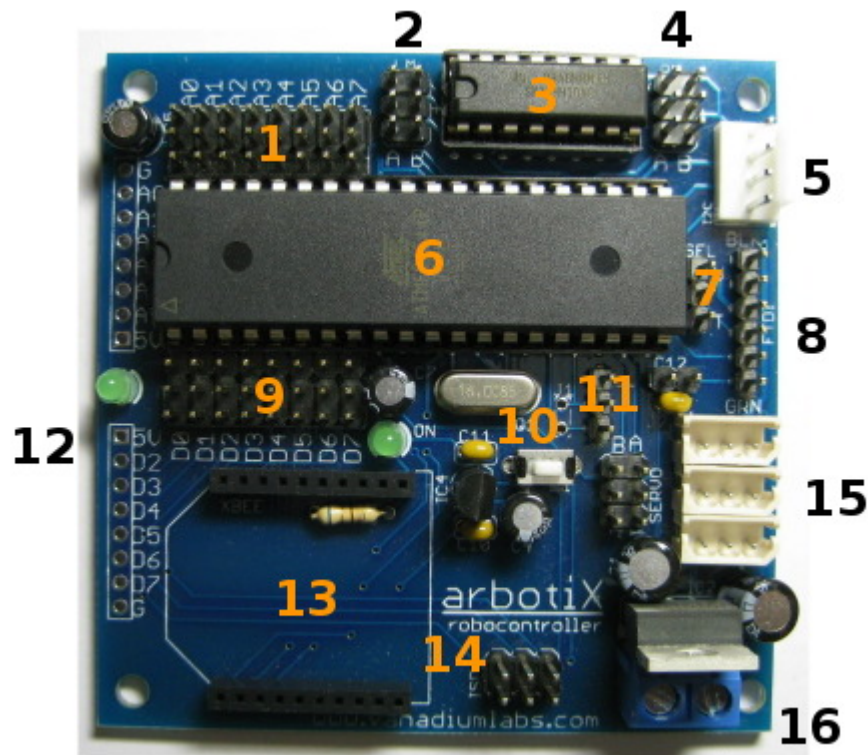

- 1 - Analog port headers
- 2 - Left motor/encoder headers
- 3 - Dual motor driver, max current 1A
- 4 - Right motor/encoder headers
- 5 - I2C header
- 6 - ATMEGA644P
- 7 - Power selection header
- 8 - FTDI serial0/programming
- 9 - Digital port headers
- 10 - Reset Switch
- 11 - Serial1 header (also J1)
- 12 - Prototyping headers and user led
- 13 - XBEE socket
- 14 - In-system programming (ISP)
- 15 - 3 Bioloid headers
- 16 - Power terminals

Applying Power

The arbotiX robocontroller requires a power supply of 6-16V, however other devices may have more stringent requirements. Power applied to the terminal blocks is denoted VIN :

1. The Bioloid bus is tied directly to VIN , if using Bioloid servos, VIN must be 7-12V, we recommend 11.1V LiPO batteries if using Bioloid servos with your arbotiX.
2. The two hobby servo headers are powered directly from VIN , considerations should be made not to over-volt any connected servos.
3. Motor supply is tied directly to VIN , care should be taken to have a safe combination of input voltage and PWM levels, so as not to over-volt attached motors.

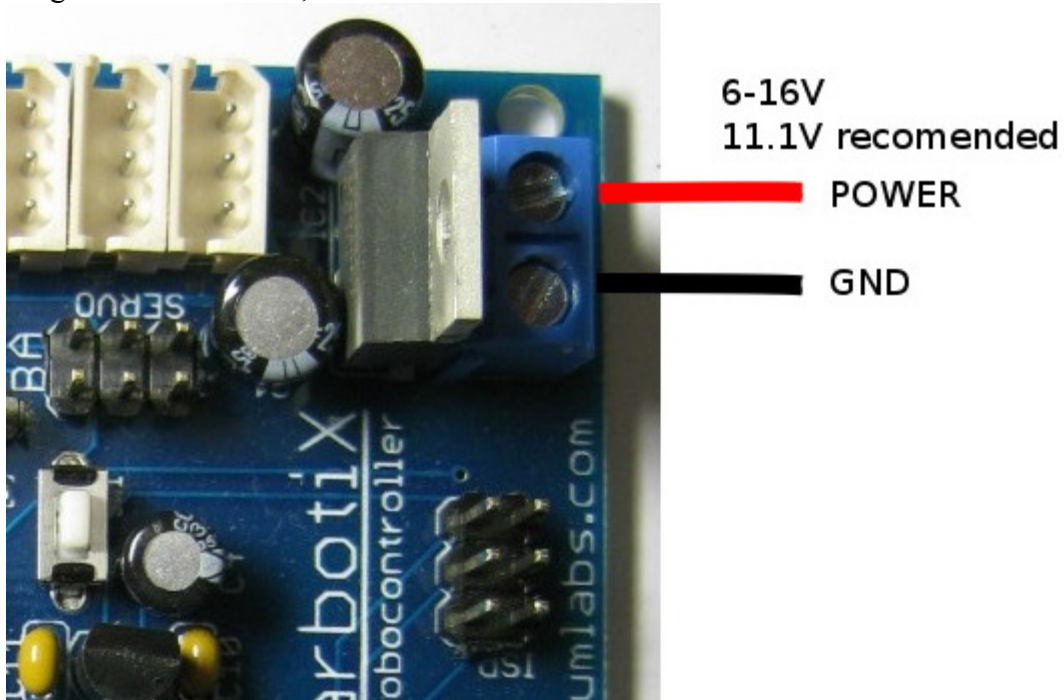

Alternatively, the onboard logic can be powered by the FTDI USB cable, if one is attached. You can select the 5V source using the jumper near the end of the AVR chip. The middle pin is attached to 5V output to the AVR. The upper pin selects 5V in from the FTDI USB cable, the lower pin selects the 5V output from the regulator that brings VIN down to 5V. If using the FTDI port to provide 5V power, the XBEE and AVR will work, however Bioloid and hobby servos, as well as the motor controller will not function.

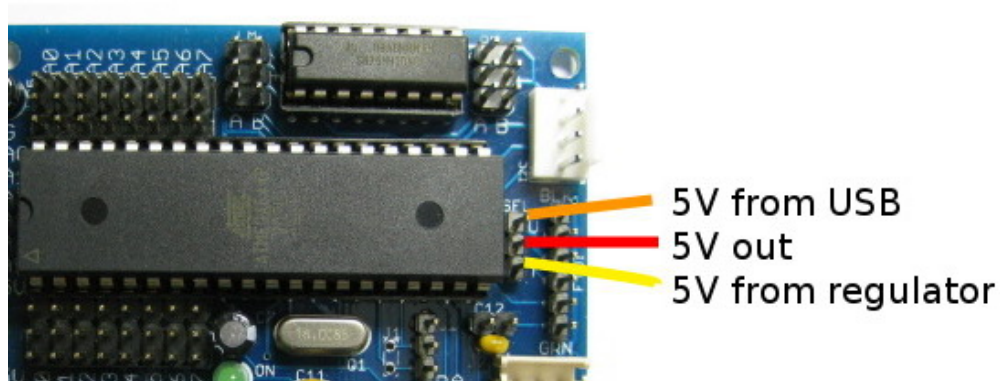

Loading Code

The arbotiX has two ways to load programs:

- with an FTDI cable, using the FTDI header. Note: We recommend the Sparkfun FTDI Basic Breakout (P/N: DEV-09115) over the regular FTDI cable because it uses DTR rather than RTS for the reset circuit.
- with an In-System Programmer, using the ISP header

The ISP header is located near the power terminals, the FTDI header is located near the AVR chip, above the Bioloid headers:

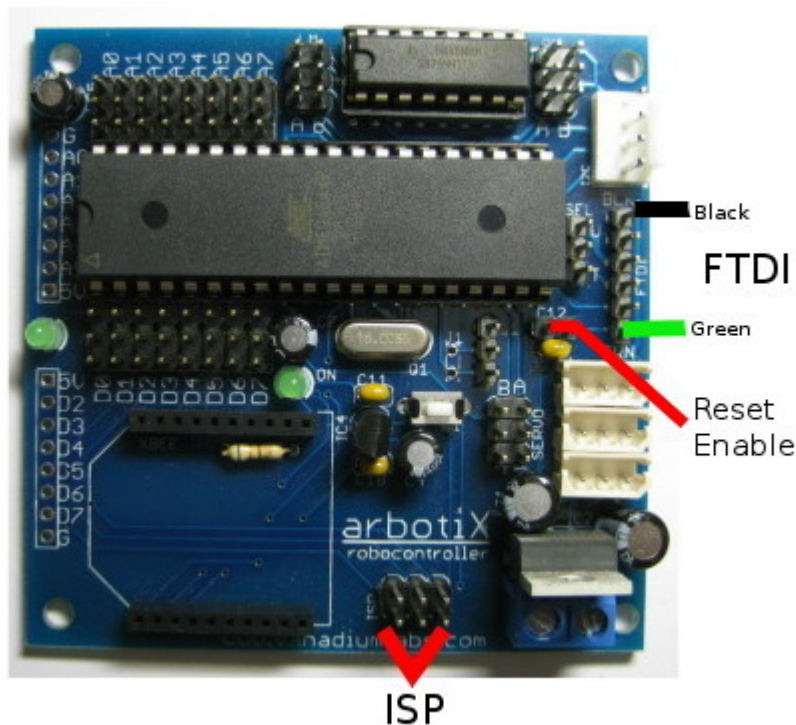

The arbotiX ships with the Sanguino bootloader installed, so that you could use the FTDI port. However, we recommend using an ISP for better reliability, and ease of use when using an XBEE radio. The arbotiX also ships with the PyPose sketch loaded, so you can get started right away doing pose and capture.

When using the FTDI port you will likely want to set the *FTDI Reset Enable* jumper above the Bioloid headers. This allows the USB port to reset the AVR when downloading sketches. The arbotiX ships with the *reset enable* jumper set.

More information, and updated links, can be found on at <http://www.vanadiumlabs.com>

Digital/Analog Headers

There are a total of 16 servo-style I/O headers on the robocontroller, 8 of which can be used as analog inputs. Each three pin header provides a signal, ground, and regulated 5V power pin. This makes it very easy to connect sensors and other electronic devices to your arbotiX.

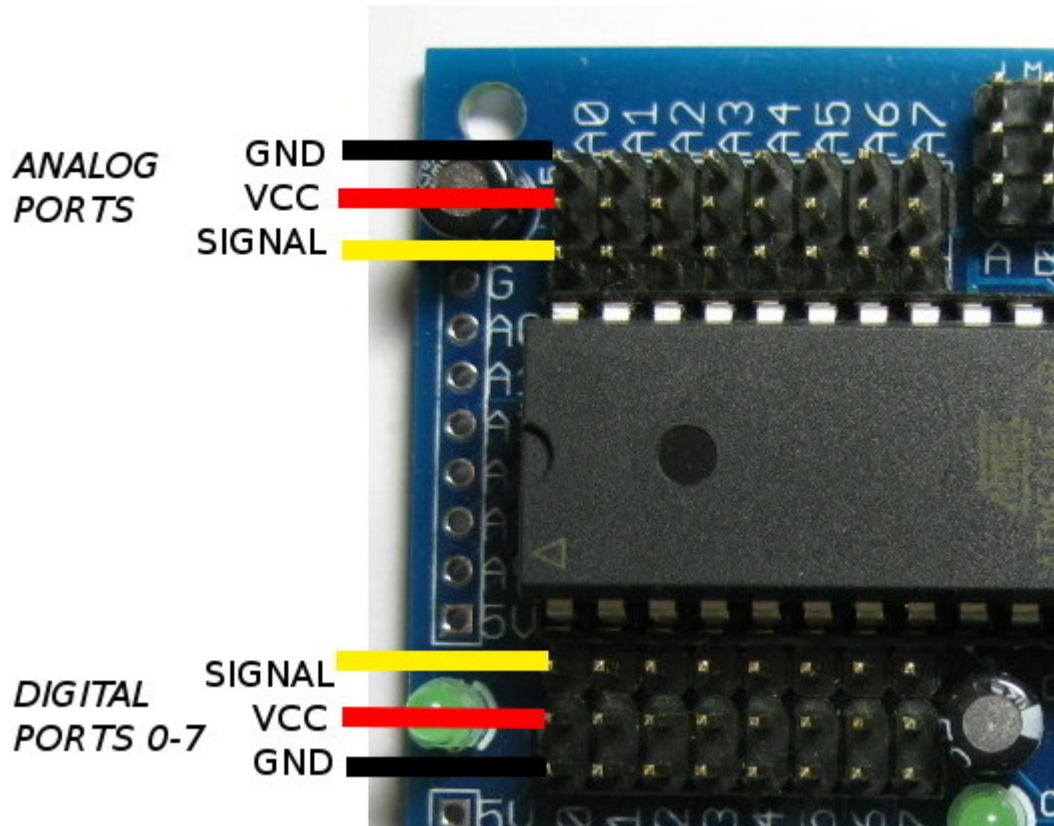

I2C and Serial Headers

Communication with external devices is very important for a robot. The arbotiX has 2 serial ports, and an I2C port. Serial0 is connected to both the FTDI header and the XBEE port. This is one of the major reasons we recommend using an ISP, since you will have to remove the XBEE radio each time you want to use the FTDI header, or the devices will fight each other. The second serial port is used for the Bioloid bus.

The I2C header has power, ground, SDA, and SCL pins. Note that there are no pull-up resistors, you'll have to mount them elsewhere.

Connecting Bioloid/Dynamixel Servos

There are three connectors for bioloid servos (AX-12+). Since the AX-12 servos are half-duplex, we have to tie the RX and TX signals together. We can do this by putting a jumper on the RX and TX pins of the Serial1 header:

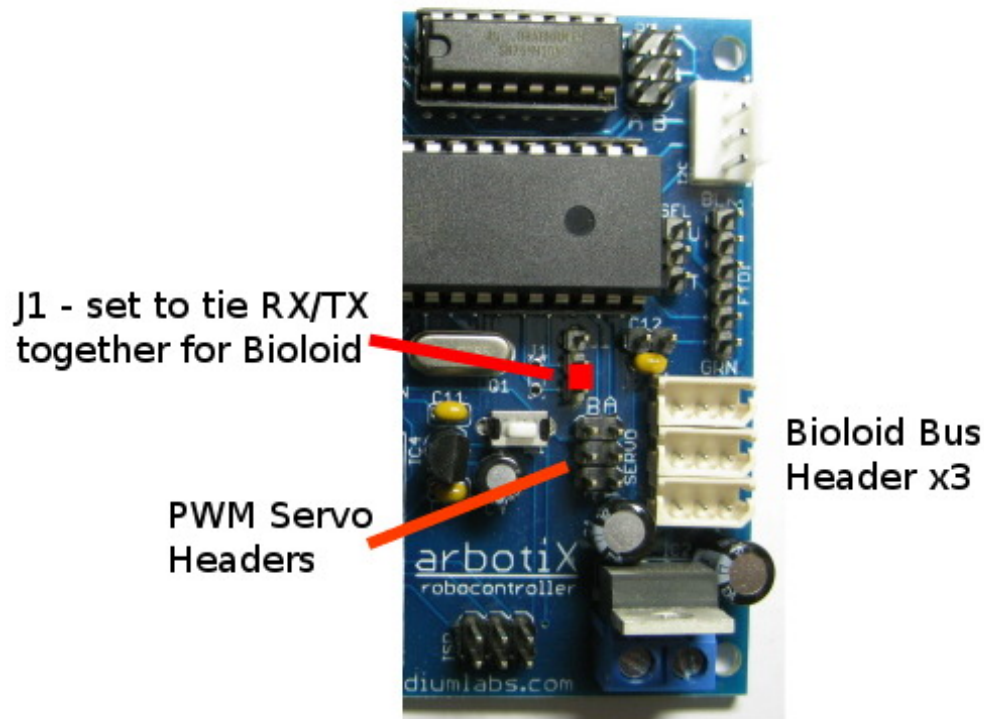

The robocontroller also includes two hobby servo connections, which can be used with traditional PWM servos. *Note: the servo signal pin is the upper pin in the picture above.*

Motor/Encoder Headers

The robocontroller has a two-channel motor driver. This will most often be used when the arbotiX is on a 2-wheel rover, as such, the motors are named Left and Right. Each motor output is capable of driving up to 1A.

The motor and encoder outputs are brought out to a 6-pin header. The outermost pins are the motor outputs. The next pair of pins are VCC and ground pins for powering encoders. The innermost pair of pins is the encoder A and B input channels. The *motors2* library can be used to drive these motors forward or backward, with up to 256 speeds in each direction. Documentation for the library can be found at <http://arbotix.googlecode.com>

XBEE Connection

The arbotiX supports a wireless connection via an XBEE serial connection. The on-board 3V regulator can only power regular XBEE models, *it cannot power an XBEE PRO module*.

A connection to your computer requires 2 XBEE radios, one on the arbotiX and one connected to your PC, and an XBEE Explorer to connect the XBEE to your PC, P/N from Trossen Robotics are:

- XBEE Radio: C-200-WLXBEE
- XBEE Explorer: C-200-WRL-08687

Prototyping Headers

Along the edge of the robocontroller there is space for several prototyping headers that are not installed. These can be plugged as either female headers, for use beside a breadboard, or as male headers, for plugging directly into a breadboard. Both configurations are shown below. Neither type of header is included with the robocontroller, however possible parts from both Jameco or Digikey are:

- Female Headers: ###
- Male Headers: ###

Software

Please visit <http://arbotix.googlecode.com> for instructions on downloading and setting up the arbotiX software.

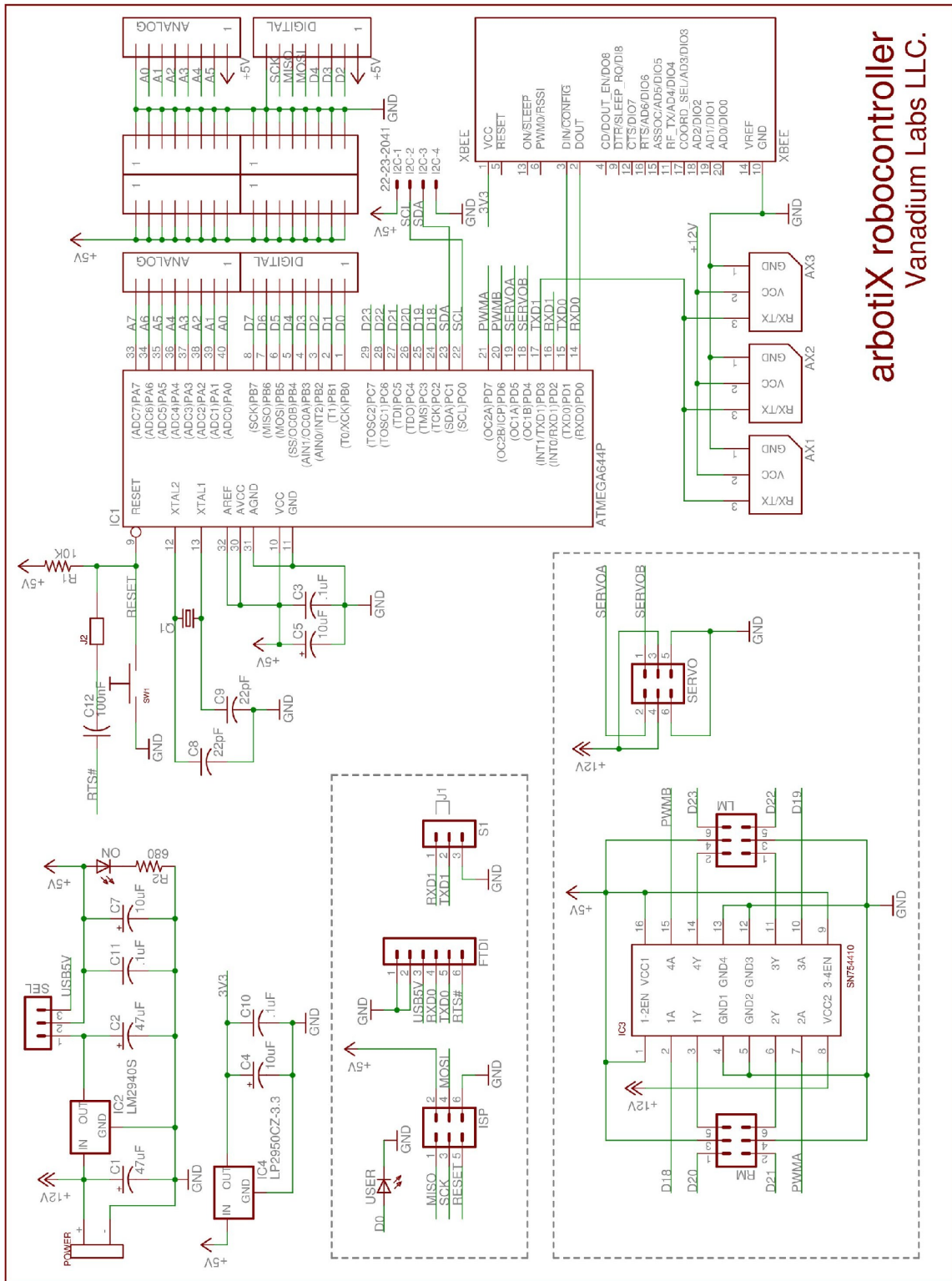

arbotiX robocontroller
Vanadium Labs LLC.