

# Low Power WiFi Module User Manual

V 1.3

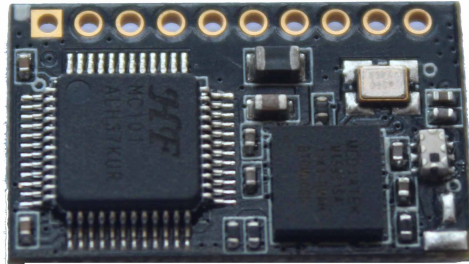

## Overview of characteristic

- ◇ Support IEEE802.11b/g/n Wireless Standards
- ◇ Based on Self-developed High Cost Effective MCU
- ◇ Ultra-Low-Power for Battery Applications with Excellent Power Save Scheme
- ◇ Support UART/PWM/GPIO Data Communication Interface
- ◇ Support Work As STA/AP/AP+STA Mode
- ◇ Support Smart Link Function (APP program provide)
- ◇ Support Wireless and Remote Firmware Upgrade Function
- ◇ support WPS Function
- ◇ Support Multi-TCP Link (5 Channel) Application
- ◇ Support Dial Switch Power Control
- ◇ Support External IPEX or Pad Interface Antenna Option
- ◇ Single +3.3V Power Supply
- ◇ Smallest Size: 22mm x 13.5mm x 6mm, 1x10 2mm Connector
- ◇ FCC/CE Certificated

**TABLE OF CONTENTS**

<b>LIST OF FIGURES</b> .....	<b>6</b>
<b>LIST OF TABLES</b> .....	<b>7</b>
<b>HISTORY</b> .....	<b>8</b>
<b>1. PRODUCT OVERVIEW</b> .....	<b>9</b>
<b>1.1. GENERAL DESCRIPTION</b> .....	<b>9</b>
1.1.1 DEVICE FEATURES.....	9
1.1.2 DEVICE PARAMETERS.....	10
1.1.3 KEY APPLICATION.....	10
<b>1.2. HARDWARE INTRODUCTION</b> .....	<b>12</b>
1.2.1. PINS DEFINITION.....	12
1.2.2. ELECTRICAL CHARACTERISTICS.....	13
1.2.3. MECHANICAL SIZE.....	14
1.2.4. EXTERNAL ANTENNA.....	15
1.2.5. EVALUATION KIT.....	15
<b>1.3. TYPICAL APPLICATION</b> .....	<b>16</b>
1.3.1. HARDWARE TYPICAL APPLICATION.....	16
1.3.2. SMART LED APPLICATION HARDWARE TYPICAL CONNECTION.....	17
<b>2. FUNCTIONAL DESCRIPTION</b> .....	<b>19</b>
<b>2.1. WIRELESS NETWORKING</b> .....	<b>19</b>
2.1.1. BASIC WIRELESS NETWORK BASED ON AP (INFRASTRUCTURE).....	19
2.1.2. WIRELESS NETWORK BASED ON AP+STA.....	19
<b>2.2. WORK MODE : TRANSPARENT TRANSMISSION MODE</b> .....	<b>20</b>
<b>2.3. UART FRAME SCHEME</b> .....	<b>21</b>
2.3.1. UART FREE-FRAME.....	21
2.3.2. UART AUTO-FRAME.....	22
<b>2.4. ENCRYPTION</b> .....	<b>22</b>
<b>2.5. PARAMETERS CONFIGURATION</b> .....	<b>22</b>
<b>2.6. FIRMWARE UPDATE</b> .....	<b>23</b>
<b>2.7. GPIO/PWM FUNCTION</b> .....	<b>24</b>
<b>2.8. SOCKET B FUNCTION</b> .....	<b>25</b>
<b>2.9. MULTI-TCP LINK CONNECTION</b> .....	<b>25</b>
<b>3. OPERATION GUIDELINE</b> .....	<b>27</b>
<b>3.1. CONFIGURATION VIA WEB ACCESSING</b> .....	<b>27</b>
3.1.1. OPEN WEB MANAGEMENT INTERFACE.....	27
3.1.2. SYSTEM PAGE.....	28
3.1.3. WORK MODE PAGE.....	28
3.1.4. STA SETTING PAGE.....	29
3.1.5. AP SETTING PAGE.....	29
3.1.6. OTHER SETTING PAGE.....	30
3.1.7. ACCOUNT MANAGEMENT PAGE.....	31

3.1.8. UPGRADE SOFTWARE PAGE.....	31
3.1.9. RESTART PAGE.....	31
3.1.10. RESTORE PAGE.....	32
<b>3.2. USR-WIFI232-T USAGE INTRODUCTION.....</b>	<b>33</b>
3.2.1. SOFTWARE DEBUG TOOLS.....	33
3.2.2. NETWORK CONNECTION.....	33
3.2.3. DEFAULT PARAMETER SETTING.....	33
3.2.4. MODULE DEBUG.....	34
<b>3.3. TYPICAL APPLICATION EXAMPLES.....</b>	<b>35</b>
3.3.1. WIRELESS CONTROL APPLICATION.....	35
3.3.2. REMOTE MANAGEMENT APPLICATION.....	36
3.3.3. TRANSPARENT SERIAL PORT APPLICATION.....	36
<b>4. AT+INSTRUCTION INTRODUCTION.....</b>	<b>37</b>
<b>4.1. CONFIGURATION MODE.....</b>	<b>37</b>
4.1.1. SWITCH TO CONFIGURATION MODE.....	37
<b>4.2. AT+ INSTRUCTION SET OVERVIEW.....</b>	<b>38</b>
4.2.1. INSTRUCTION SYNTAX FORMAT.....	38
4.2.2. AT+ INSTRUCTION SET.....	39
4.2.2.1. AT+E.....	41
4.2.2.2. AT+WMODE.....	41
4.2.2.3. AT+ENTM.....	42
4.2.2.4. AT+TMODE.....	42
4.2.2.5. AT+MID.....	42
4.2.2.6. AT+VER.....	42
4.2.2.7. AT+RELD.....	43
4.2.2.8. AT+FCLR.....	43
4.2.2.9. AT+Z.....	43
4.2.2.10. AT+H.....	43
4.2.2.11. AT+CFGRD.....	43
4.2.2.12. AT+CFGWR.....	43
4.2.2.13. AT+CFGFR.....	44
4.2.2.14. AT+CFGTF.....	44
4.2.2.15. AT+UART.....	44
4.2.2.16. AT+ UARTF.....	45
4.2.2.17. AT+ UARTFT.....	45
4.2.2.18. AT+ UARTFL.....	45
4.2.2.19. AT+ UARTTE.....	46
4.2.2.20. AT+ SEND.....	46
4.2.2.21. AT+ RECV.....	46
4.2.2.22. AT+ PING.....	46
4.2.2.23. AT+NETP.....	47
4.2.2.24. AT+ MAXSK.....	47
4.2.2.25. AT+ TCPLK.....	48
4.2.2.26. AT+ TCPTO.....	48

4.2.2.27. AT+TCPDIS.....	48
4.2.2.28. AT+SOCKB.....	49
4.2.2.29. AT+TCPDISB.....	49
4.2.2.30. AT+TCPTOB.....	49
4.2.2.31. AT+TCPLKB.....	50
4.2.2.32. AT+SNDB.....	50
4.2.2.33. AT+RCVB.....	50
4.2.2.34. AT+WSSSID.....	50
4.2.2.35. AT+WSKEY.....	51
4.2.2.36. AT+ WANN.....	51
4.2.2.37. AT+ WSMAC.....	52
4.2.2.38. AT+ WSLK.....	52
4.2.2.39. AT+ WSLQ.....	52
4.2.2.40. AT+WSCAN.....	52
4.2.2.41. AT+ WSDNS.....	53
4.2.2.42. AT+ LANN.....	53
4.2.2.43. AT+WAP.....	53
4.2.2.44. AT+WAKEY.....	54
4.2.2.45. AT+WAMAC.....	54
4.2.2.46. AT+WADHCP.....	54
4.2.2.47. AT+WADMN.....	55
4.2.2.48. AT+PLANG.....	55
4.2.2.49. AT+UPURL.....	55
4.2.2.50. AT+UPFILE.....	56
4.2.2.51. AT+UPWEB.....	56
4.2.2.52. AT+UPCFG.....	56
4.2.2.53. AT+UPNVR.....	56
4.2.2.54. AT+UPAUTO.....	57
4.2.2.55. AT+LOGSW.....	57
4.2.2.56. AT+LOGPORT.....	57
4.2.2.57. AT+UPST.....	58
4.2.2.58. AT+WEBU.....	58
4.2.2.59. AT+MSLP.....	58
4.2.2.60. AT+NTPRF.....	58
4.2.2.61. AT+NTPEN.....	59
4.2.2.62. AT+NTPTM.....	59
4.2.2.63. AT+WRMID.....	59
4.2.2.64. AT+RLDEN.....	59
4.2.2.65. AT+ASWD.....	60
4.2.2.66. AT+MDCH.....	60
4.2.2.67. AT+TXPWR.....	60
4.2.2.68. AT+LPTIO.....	61
<b>5. PACKAGE INFORMATION.....</b>	<b>62</b>
<b>5.1. RECOMMENDED REFLOW PROFILE.....</b>	<b>62</b>

---

5.2. DEVICE HANDLING INSTRUCTION (MODULE IC SMT PREPARATION) .....	62
5.3. SHIPPING INFORMATION.....	63
APPENDIX A: HW REFERENCE DESIGN.....	64
APPENDIX B: CONTROL GPIO/PWM FUNCTION WITH NETWORK COMMANDS.....	66
B.1 NETWORK COMMAND.....	66
B.2 HEXADECIMAL NETWORK COMMAND.....	69
APPENDIX C: HTTP PROTOCOL TRANSFER.....	71
C.1. HTTP AT COMMAND.....	71
C.1.1. AT+ HTTPURL.....	71
C.1.2. AT+ HTTPTP.....	71
C.1.3. AT+ HTTPPH.....	71
C.1.4. AT+ HTTPCN.....	72
C.1.5. AT+ HTTPUA.....	72
C.1.6. AT+ HTTPDT.....	72
C.2. HTTP EXAMPLE.....	72
APPENDIX D: CONTACT INFORMATION.....	74

**LIST OF FIGURES**

Figure 1. USR-WIFI232-T Pins Map.....	13
Figure 2. USR-WIFI232-T Mechanical Dimension.....	15
Figure 3. USR-WIFI232-T External Antenna picture.....	16
Figure 4. USR-WIFI232-T Evaluation Kit.....	16
Figure 5. USR-WIFI232-T Hardware Typical Application.....	17
Figure 6. USR-WIFI232-T Smart LED Application Hardware Connection.....	18
Figure 7. USR-WIFI232-T Basic Wireless Network Structure.....	20
Figure 8. AP+STA Network Structure.....	21
Figure 9. Socket B function demo.....	26
Figure 10. Multi-TCP Link Data Transmission Structure.....	26
Figure 11. Open Web Management page.....	28
Figure 12. System Web Page.....	29
Figure 13. Work Mode Page.....	30
Figure 14. STA Setting Page.....	30
Figure 15. AP Setting Page.....	31
Figure 16. Other Setting Page.....	31
Figure 17. Account Page.....	32
Figure 18. Upgrade SW page.....	32
Figure 19. Restart Page.....	33
Figure 20. Restore Page.....	33
Figure 21. STA Interface Debug Connection.....	34
Figure 22. AP Interface Debug Connection.....	34
Figure 23. "CommTools" Serial Debug Tools.....	35
Figure 24. "TCPUDPDbg" Tools Create Connection.....	35
Figure 25. "TCPUDPDbg" Tools Setting.....	35
Figure 26. "TCPUDPDbg" Tools Connection.....	36
Figure 27. Wireless Control Application.....	36
Figure 28. Remote Management Application.....	37
Figure 29. Transparent Serial Port Application.....	37
Figure 30. USR-WIFI232-T Default UART Port Parameters.....	38
Figure 31. Switch to Configuration Mode.....	38
Figure 32. "AT+H" Instruction for Help.....	39
Figure 33. Reflow Soldering Profile.....	63

**LIST OF TABLES**

Table 1	USR-WIFI232-T Module Technical Specifications.....	10
Table 2	USR-WIFI232-T Pins Definition.....	12
Table 3	Absolute Maximum Ratings.....	13
Table 4	Power Supply & Power Consumption.....	13
Table 5	USR-WIFI232-T External Antenna Parameters.....	15
Table 6	USR-WIFI232-T Evaluation Kit Interface Description.....	15
Table 7	USR-WIFI232-T GPIO/PWM Pin Mapping Table.....	23
Table 8	USR-WIFI232-T Web Access Default Setting.....	25
Table 9	Error Code Description.....	37
Table 10	AT+ Instruction Set List.....	37
Table 11	Reflow Soldering Parameter.....	60

## HISTORY

**Ed. v1.0** 08-01-2013 First Version.

**Ed. v1.1** 09-11-2013 Update AT command.

**Ed. v1.2** 10-12-2013 Update AT command. Update PWM/GPIO function. Add HTTP protocol demo. Add auto-frame function.

**Ed. v1.3** 10-18-2013 Add nReload Pin wireless upgrade and config description, add nLink Pin wireless upgrade indication description.



# 1. PRODUCT OVERVIEW

## 1.1. General Description

The USR-WIFI232-T is a fully self-contained small form-factor, single stream, 802.11b/g/n Wi-Fi module, which provide a wireless interface to any equipment with a Serial/SPI/USB interface for data transfer. USR-WIFI232-T integrate MAC, baseband processor, RF transceiver with power amplifier in hardware and all Wi-Fi protocol and configuration functionality and networking stack, in embedded firmware to make a fully self-contained 802.11b/g/n Wi-Fi solution for a variety of applications.

The USR-WIFI232-T employs the world's lowest power consumption embedded architecture. It has been optimized for all kinds of client applications in the home automation, smart grid, handheld device, personal medical application and industrial control that have lower data rates, and transmit or receive data on an infrequent basis.

The USR-WIFI232-T integrates all Wi-Fi functionality into a low-profile, 23.1x32.8x 2.7mm SMT module package that can be easily mounted on main PCB with application specific circuits. Also, module provides built-in antenna, external antenna option.

### 1.1.1 Device Features

- Single stream Wi-Fi @ 2.4 GHz with support for WEP security mode as well as WPA/WPA2
- Based on Self-developed High Cost Performance MCU
- Ultra-low-power operation with all kinds of power-save modes.
- Includes all the protocol and configuration functions for Wi-Fi connectivity.
- Support STA/AP/AP+STA Mode
- Support Smart Link Function
- Support Wireless and Remote Firmware Upgrade Function
- Support External IPEX or Pad Interface antenna connector options.
- Support Dial Switch to Control Power
- Support Max 3 Channel PWM Output
- Compact surface mount module 22mm x 13.5mm x 6mm
- Full IPv4 and IPv6 stack.
- Low power RTOS and drivers.
- FCC Certified.
- RoHS and CE compliant.
- Single supply - 3.3V operation.

1.1.2 Device Parameters

Table 1 USR-WIFI232-T Module Technical Specifications

Class	Item	Parameters	
<b>Wireless Parameters</b>	Certification	FCC/CE	
	Wireless standard	802.11 b/g/n	
	Frequency range	2.412GHz-2.484GHz	
	Transmit Power	802.11b: +16 +/-2dBm (@11Mbps)	
		802.11g: +14 +/-2dBm (@54Mbps)	
		802.11n: +13 +/-2dBm (@HT20, MCS7)	
	Receiver Sensitivity	802.11b: -93 dBm (@11Mbps ,CCK)	
802.11g: -85 dBm (@54Mbps, OFDM)			
802.11n: -82 dBm (@HT20, MCS7)			
Antenna Option	External:I-PEX Connector		
	External:Pad connector		
<b>Hardware Parameters</b>	Data Interface	UART	
		PWM, GPIO	
	Operating Voltage	2.8~3.6V	
	Operating Current	Peak [Continuous TX]: ~200mA Normal [WiFi ON/OFF, DTIM=100ms]: Average. ~12mA, Peak: 200mA Standby [WiFi Shutdown]: <200uA Power Down Switch: <10uA	
		Operating Temp.	-40°C- 85°C
		Storage Temp.	-45°C- 125°C
	Dimensions and Size	22mm x 13.5mm x 6mm	
	External Interface	1x10, 2mm DIP	
<b>Software Parameters</b>	Network Type	STA /AP/STA+AP	
	Security Mechanisms	WEP/WPA-PSK/WPA2-PSK	
	Encryption	WEP64/WEP128/TKIP/AES	
	Update Firmware	Local Wireless, Remote	
	Customization	Web Page Upgrade	
	Network Protocol	IPv4, IPv6,TCP/UDP/FTP/HTTP	
	User Configuration	AT+instruction set. Android/iOS Smart Link APP tools	

1.1.3 Key Application

- Remote equipment monitoring
- Asset tracking and telemetry

- Security
- Industrial sensors and controls
- Home automation
- Medical devices

## 1.2. Hardware Introduction

### 1.2.1. Pins Definition

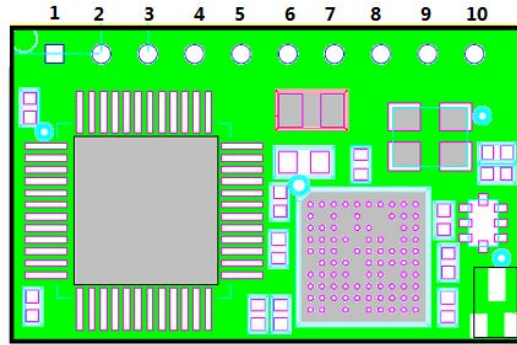

Figure 1. USR-WIFI232-T Pins Map

Table 2 USR-WIFI232-T Pins Definition

Pin	Description	Net Name	Signal Type	Comments
1	Ground	GND	Power	
2	+3.3V Power	DVDD	Power	3.3V@250mA
3	Restore Configuration	nReload	I,PU	<a href="#">Detailed functions see &lt;Notes&gt;</a>
4	Module Reset	EXT_RESETn	I,PU	"Low" effective reset input.
5	UART0	UART0_RX	I	GPIO5, No connect if not use.
6	UART0	UART0_TX	O	GPIO6, No connect if not use.
7	Power Control Switch	PWR_SW	I,PU	"0" - Power Down Mode (Lowest Power Consumption) "1" - Normal mode
8	PWM Channel 3	PWM_3	I/O	Can be configured as WPS/GPIO18 No connect if not use.
9	PWM Channel 2	PWM_2	I/O	Can be configured as nReady/GPIO12. No connect if not use.
10	PWM Channel 1	PWM_1	I/O	Can be configured as nLink/GPIO11. <a href="#">Detailed functions see &lt;Notes&gt;</a>

#### <Notes>

##### nReload Pin (Button) function:

1. When this pin is set to "low" during module boot up, the module will enter wireless firmware and config upgrade mode. This mode is used for customer manufacture.

(USR Technology will provide software tools for customer batch configuration and upgrade firmware during mass production)

2. After module is powered up, short press this button ( "Low" < 3s ) to make the module go into "Smart Link " config mode, waiting for APP to set password and other information.
3. After module is powered up, long press this button ( "Low" > 3s ) to make the module recover to factory setting.

USR Technology strongly suggest customer fan out this pin to connector or button for "Manufacture" and " Smart Link" application.

nLink Pin (LED) function:

1. At wireless firmware and config upgrade mode , this LED used to indicate configure and upgrade status.
2. At "Smart Link " config mode, this LED used to indicate APP to finish setting.
3. At normal mode, it's Wi-Fi link status indicator

USR Technology strongly suggest customer fan out this pin to LED.

**1.2.2. Electrical Characteristics**

Table 3 Absolute Maximum Ratings:

Parameter	Condition	Min.	Typ.	Max.	Unit
Storage temperature range		-45		125	°C
Maximum soldering temperature	IPC/JEDEC J-STD-020			260	°C
Supply voltage		0		3.8	V
Voltage on any I/O pin		0		3.3	V
ESD (Human Body Model HBM)	TAMB=25°C			2	KV
ESD (Charged Device Model, CDM)	TAMB=25°C			1	KV

Table 4 Power Supply & Power Consumption:

Parameter	Condition	Min.	Typ.	Max.	Unit
Operating Supply voltage		2.8	3.3	3.8	V
Supply current, peak	Continuous Tx		200		mA
Supply current, IEEE PS	DTIM=100ms		12		mA
Output high voltage	Sourcing 6mA	2.8			V
Output low voltage	Sinking 6mA			0.2	V
Input high voltage		2.2			V
Input low voltage				0.8	V

**1.2.3. Mechanical Size**

USR-WIFI232-T modules physical size (Unit: mm) as follows:

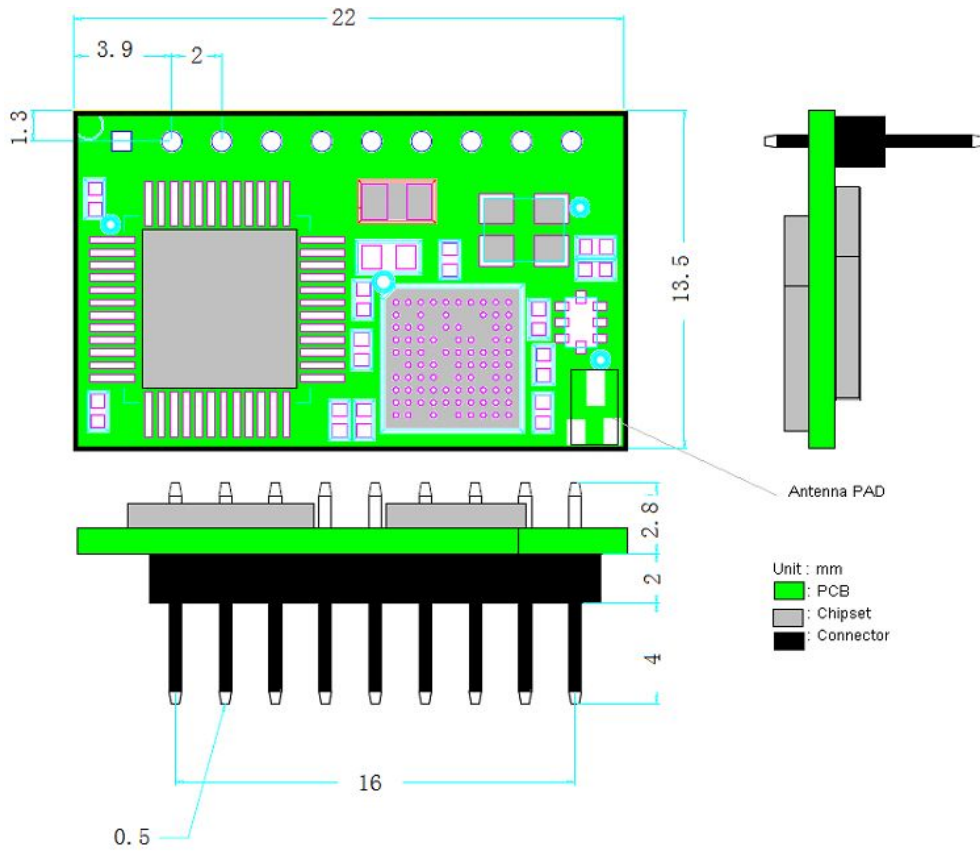

Figure 2. USR-WIFI232-T Mechanical Dimension

**1.2.4. External Antenna**

USR-WIFI232-T supports two way of external antenna as the following picture show, The IPEX interface or the PAD interface. The user may choose one of them. If user select external antenna, USR-WIFI232-T modules must be connected to the 2.4G antenna according to IEEE 802.11b/g/n standards. The antenna parameters required as follows:



Figure 3. USR-WIFI232-T External Antenna picture

Table 5 USR-WIFI232-T External Antenna Parameters

Item	Parameters
Frequency range	2.4~2.5GHz
Impedance	50 Ohm
VSWR	2 (Max)
Return Loss	-10dB (Max)
Connector Type	I-PEX or populate directly

1.2.5. Evaluation Kit

USR Technology provides the evaluation kit to promote user to familiar the product and develop the detailed application. The evaluation kit shown as below, user can connect to USR-WIFI232-T module with the RS-232 UART, manage the module or do the some functional tests. The EVK support 5V DC power supply.

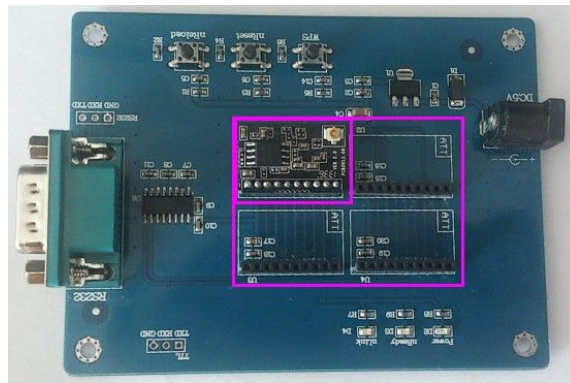

Figure 4. USR-WIFI232-T Evaluation Kit

The external interface description for evaluation kit as follows:

Table 6 USR-WIFI232-T Evaluation Kit Interface Description

Function	Name	Description
External Interface	RS232	Main data/command RS-232 interface
	DC5V	DC jack for power in, 5V input.
Button	nReset	Used to reset the module.
	nReload	Restore factory default configuration after push this pin more than 3s. <a href="#">See 1.2.1</a>

### 1.3. Typical Application

#### 1.3.1. Hardware Typical Application

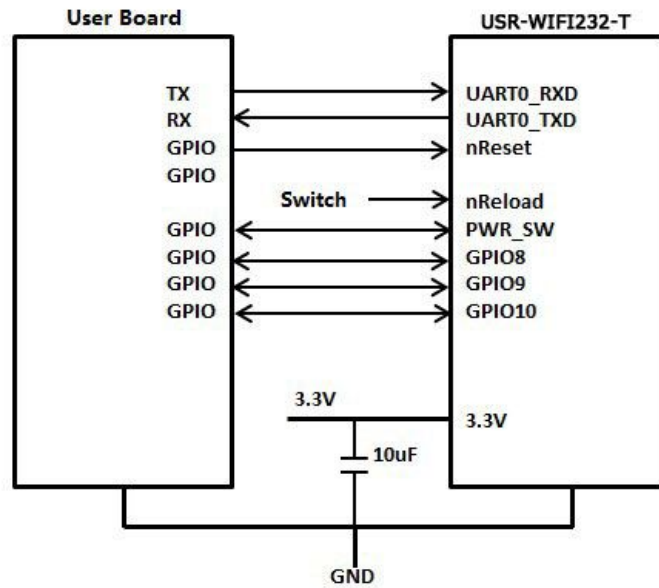

Figure 5. USR-WIFI232-T Hardware Typical Application

#### 1.3.2. Smart LED Application Hardware Typical Connection

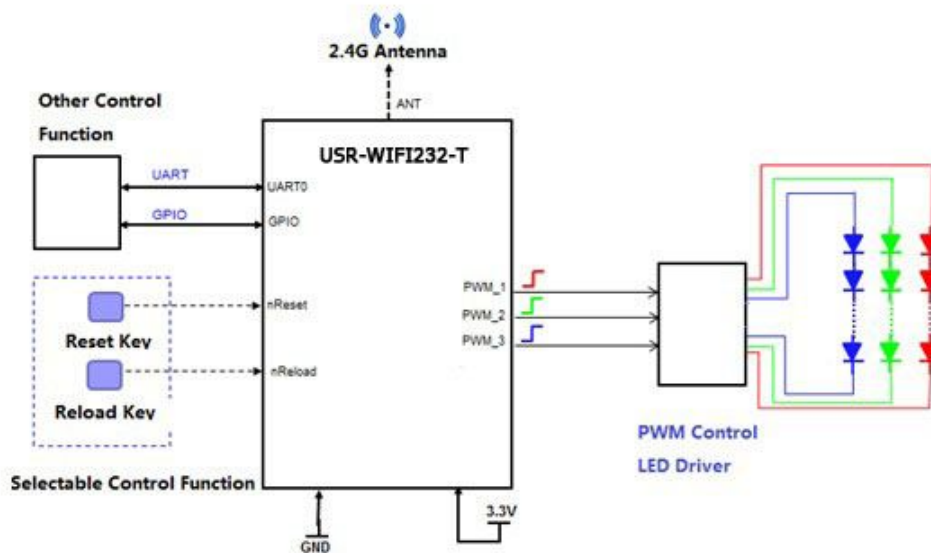

Figure 6. USR-WIFI232-T Smart LED Application Hardware Connection

**Notes:**



**nReset-** Module hardware reset signal. Input. Logics "0" effective.  
There is pull-up resistor internal and no external pull-up required. When module power up or some issue happened, MCU need assert nRST signal "0" at least 10ms, then set "1" to keep module fully reset.

**nReload-** Module restore to factory default configuration. Input. Logics "0" effective.

**(This pin is recommend to connect to button, is used to enter wireless upgrade mode)**

User can de-assert nReload signal "0" more than 3s through button or MCU pin, then release, module will restore to factory default configuration and re-start boot up process.. If nReload function not required, can leave this pin open.

**UART0\_TXD/RXD-** UART port data transmit and receive signal.

**PWM-n-** PWM control signal output. It can also be configured as GPIO output. "AT+LPTIO=on" command configure PWM\_1 pin as nLink, PWM\_2 pin as nReady, PWM\_3 as WPS function.

**nReset-** Module hardware reset signal. Input. Logics "0" effective.  
There is pull-up resistor internal and no external pull-up required. When module power up or some issue happened, MCU need assert nRST signal "0" at least 10ms, then set "1" to keep module fully reset.

**nLink-** Module WIFI connection status indication. Output.

**(This pin is recommend to connect to LED, indicate status when the module in wireless upgrade mode)**

When module connects to AP (AP associated), this pin will output "0". This signal used to judge if module already at WiFi connection status. There is pull-up resistor internal and no external pull-up required. If nLink function not required, can leave this pin open.

## 2. FUNCTIONAL DESCRIPTION

### 2.1. Wireless Networking

USR-WIFI232-T module can be configured as both wireless STA and AP base on network type. Logically there are two interfaces in USR-WIFI232-T. One is for STA, and another is for AP. When USR-WIFI232-T works as AP, other STA equipments are able to connect to wireless LAN via USR-WIFI232-T module. Wireless Networking with USR-WIFI232-T is very flexible.

#### **Notes:**

**AP:** that is the wireless Access Point, the founder of a wireless network and the center of the network nodes. The wireless router we use at home or in office may be an AP.

**STA:** short for Station, each terminal connects to a wireless network (such as laptops, PDA and other networking devices) can be called with a STA device.

#### 2.1.1. Basic Wireless Network Based On AP (Infrastructure)

Infrastructure: it's also called basic network. It built by AP and many STAs which join in.

The characters of network of this type are that AP is the center, and all communication between STAs is transmitted through the AP. The figure following shows such type of networking.



Figure 7. USR-WIFI232-T Basic Wireless Network Structure

#### 2.1.2. Wireless Network Based On AP+STA

USR-WIFI232-T module support AP+STA network mode, means module support one AP interface and one STA interface at the same time, as following figure,

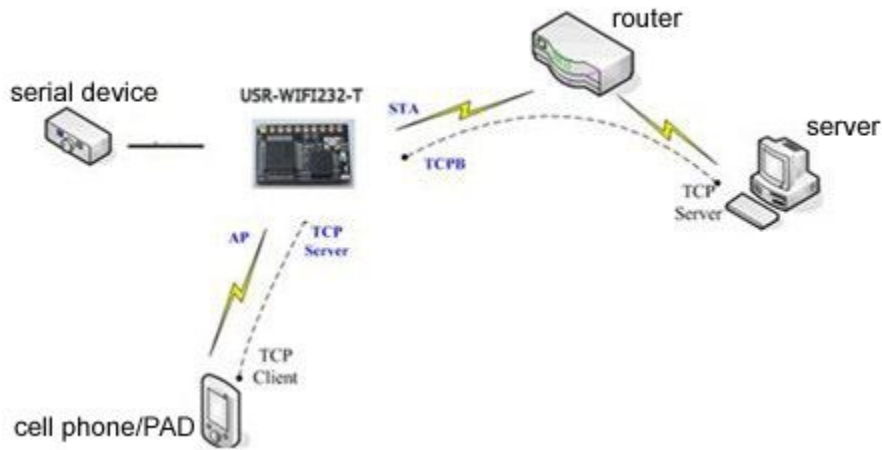

Figure 8. AP+STA Network Structure

When module enables AP+STA function, Module's STA interface can connect with router and connect to TCP server in the network. At the same time, module's AP interface is also active and permit phone/PAD to connect through TCPB, then phone/PAD can control user device and and setting the module parameters,

The advantage of AP+STA mode is:

- Users can easily setting and track user device through Phone/PAD and not change the original network setting.
- Users can easily setting module's parameters through WiFi when module works as STA mode.

## 2.2. Work Mode : Transparent Transmission Mode

USR-WIFI232-T module support serial interface transparent transmission mode. The benefit of this mode is achieves a plug and play serial data port, and reduces user complexity furthest. In this mode, user should only configure the necessary parameters. After power on, module can automatically connect to the default wireless network and server.

As in this mode, the module's serial port always work in the transparent transmission mode, so users only need to think of it as a virtual serial cable, and send and receive data as using a simple serial. In other words, the serial cable of users' original serial devices is directly replaced with the module; user devices can be easy for wireless data transmission without any changes.

The transparent transmission mode can fully compatible with user's original software platform and reduce the software development effort for integrate wireless data transmission.

The parameters which need to configure include:

- **Wireless Network Parameters**
  - Wireless Network Name (SSID)
  - Security Mode
  - Encryption Key
- **TCP/UDP Linking Parameters**
  - Protocol Type
  - Link Type (Server or Client)
  - Target Port ID Number
  - Target Port IP Address
- **Serial Port Parameters**
  - Baud Rate
  - Data Bit
  - Parity (Check) Bit
  - Stop Bit
  - Hardware Flow Control

## 2.3. UART Frame Scheme

### 2.3.1. UART Free-Frame

USR-WIFI232-T support UART free-frame function. If user select open this function, module will check the intervals between any two bytes when receiving UART data. If this interval time exceeds defined value (50ms default), USR-WIFI232-T will think it as the end of one frame and transfer this free-frame to WiFi port, or USR-WIFI232-T will receive UART data until 1000 bytes, then transfer 1000 bytes frame to WiFi port.

USR-WIFI232-T's default interval time is 50ms. User can also set this interval to fast (10ms) through AT command. But user have to consider if user MCU can send UART data with 10ms interval ,or the UART data may be divide as fragment.

Through AT command: AT+UARTTE=fash/normal, user can set the interval time: fast (10ms) and normal (50ms).

### 2.3.2. UART Auto-Frame

USR-WIFI232-T support UART auto-frame function. If user select open this function and setting auto-frame trigger length and auto-frame trigger time parameters, then module will auto framing the data which received from UART port and transmitting to the network as pre-defined data structure.

- **Auto-frame trigger length:** The fixed data length that module used to transmitting to the network.

- **Auto-frame trigger time:** After the trigger time, if UART port received data can't reach auto-frame trigger length, then module will transmitting available data to the network and bypass the auto-frame trigger length condition.

Detailed UART auto-frame function can refer to AT+ instruction set "UARTF/UARTFT/UARTFL" introduction.

## 2.4. Encryption

Encryption is a method of scrambling a message that makes it unreadable to unwanted parties, adding a degree of secure communications. There are different protocols for providing encryption, and the USR-WIFI232-T module supports following:

- ◆ WEP
- ◆ WPA-PSK/TKIP
- ◆ WPA-PSK/AES
- ◆ WPA2-PSK/TKIP
- ◆ WPA2-PSK/AES

## 2.5. Parameters Configuration

USR-WIFI232-T module supports two methods to configuration parameters: **Web Accessing** and **AT+instruction set**.

Web accessing means users can configure parameters through Web browser.

When USR-WIFI232-T module connected to wireless network, parameters configuration is done on a PC connected to the same wireless network.

AT+instruction set configuration means user configure parameters through serial interface command. Refer to "AT+instruction set" chapter for more detail.

## 2.6. Firmware Update

USR-WIFI232-T module supports two on-line upgrade methods:

- Webpage Wi-Fi Upgrade
- Remote Upgrade

Webpaged based Wi-Fi upgrade, please refer to 3.1.8 firmware upgrade page , user can upload firmware file from PC to USR-WIFI232-T.

USR-WIFI232-T module also support upgrade from remote HTTP server, keep module connects to AP router before excuate remote HTTP upgrade. Remote upgrade have two methods: **Direct Download and Upgrade, Configure File Based Upgrade.**

### ◆ Configure File Based Upgrade

AT+UPURL command to set the remote directory which the configuration file located

AT+UPFILE command to set the configuration file name, such as

AT+UPFILE=config.txt

AT+UPST command to start remote Application upgrade. After execute this command, the module will firstly download configuration file ("config.txt"), then download the upgrade file base on the URL address listed in the configure file.

AT+UPWEB command to start remote Webpage upgrade. After execute this command, the module will firstly download configuration file ("config.txt"), then download the upgrade file base on the WEB address listed in the configure file.

AT+UPCFG command to start remote Factory Config upgrade. After execute this command, the module will firstly download configuration file ("config.txt"), then download the upgrade file base on the CFG address listed in the configure file.

AT+UPNVR command to start remote NVRAM Data upgrade. After execute this command, the module will firstly download configuration file ("config.txt"), then download the upgrade file base on the NVR address listed in the configure file.

AT+UPAUTO command to start remote upgrade. After execute this command, the module will firstly download configuration file ("config.txt"), then download the upgrade file base on the URL,WEB,CFG address listed in the configure file. It include the functions of AT+UPST,AT+UPWEB,AT+UPCFG.

General "config.txt" file format as following example:

```
[URL]="http://10.10.100.100:80/lpb.bin"  
[WEB]="http://10.10.100.100:80/web.bin"  
[NVR]="http://10.10.100.100:80/nvram.dat"  
[CFG]= "http://10.10.100.100:80/cfg.bin"
```

[URL]= the URL address of Application.

[WEB]=the URL address of Webpage

[NVR]= the URL address of NVRAM data

[CFG]= the URL address of Factory Parameter File

#### ◆ Direct Download and Upgrade

AT+UPURL command to set the remote directory and file name

After execute this command, the module will directly download the "lpb.bin" file from remote directory and start upgrade Application.

**Notes:** please contact with USR Technology technical people before upgrade firmware, or maybe damage the module and can't work again.

## 2.7. GPIO/PWM Function

USR-WIFI232-T module can provide many GPIOs, which include max 3 PWM control pins. User devices can read/write GPIO/PWM pins status.

Table 7 USR-WIFI232-T GPIO/PWM Pin Mapping Table

Pin Num	Configured Function	Description	Default Setting	Type
5	UART0_RX	UART0_RX	GPIO5	I
6	UART0_TX	UART0_TX	GPIO6	O
8	PWM Channel 3	PWM_3	GPIO18	I/O
9	PWM Channel 2	PWM_2	GPIO12	I/O
10	PWM Channel 1	PWM_1	GPIO11	I/O

When module works at PWM mode, PC and other equipments can setup connection (TCP/UDP) through WiFi, then read/write GPIO/PWM information through command.

- GPIO n OUT 0, Set GPIO n as output and output '0', Response GPIO OK or GPIO NOK;
- GPIO n OUT 1, Set GPIO n as output and output '1', Response GPIO OK or GPIO NOK;
- GPIO n GET, Read GPIO n pin status, Response +ok=1 or GPIO NOK
- GPIO n SET, Save GPIO n set, Response GPIO OK or GPIO NOK
- PWM n frequency duty, Set PWM n Channel output, Response GPIO OK or GPIO NOK
- PWM n GET, Read PWM n Channel set, Response +ok=frequency duty or PWM NOK
- PWM n SET, Save PWM n Channel set, Response PWM OK or PWM NOK

**Notes:** Please refer to Appendix B for details to use GPIO/PWM.

## 2.8. SOCKET B Function

USR-WIFI232-T support double socket communication, the socket B function is disabled by default.

After the module is started, send command "AT+SOCKB" to set the connection parameter, send command "AT+TCPDISB=on" to try to connect with TCP server, the module will stop connecting after three failures. Send command "AT+TCPDISB=on" to make connection. Send command "AT+TCPDISB=off" to close connection. Send command "AT+TCPLKB" to inquire TCP connection.

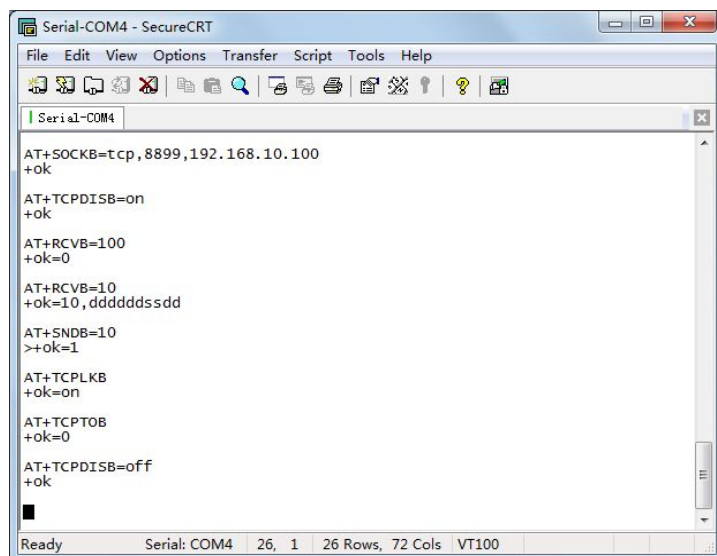

Figure 9. Socket B function demo

### 2.9. Multi-TCP Link Connection

When USR-WIFI232-T module configured as TCP Server, it supports Multi-TCP link connection, and maximum 5 TCP clients permit to connect to USR-WIFI232-T module. User can realize multi-TCP link connection at each work mode.

Multi-TCP link connection will work as following structure:

Upstream: All dates from different TCP connection or client will be transmitted to the serial port as a sequence.

Downstream: All data from serial port (user) will be duplicate and broadcast to every TCP connection or client.

Detailed multi-TCP link data transmission structure as following figure:

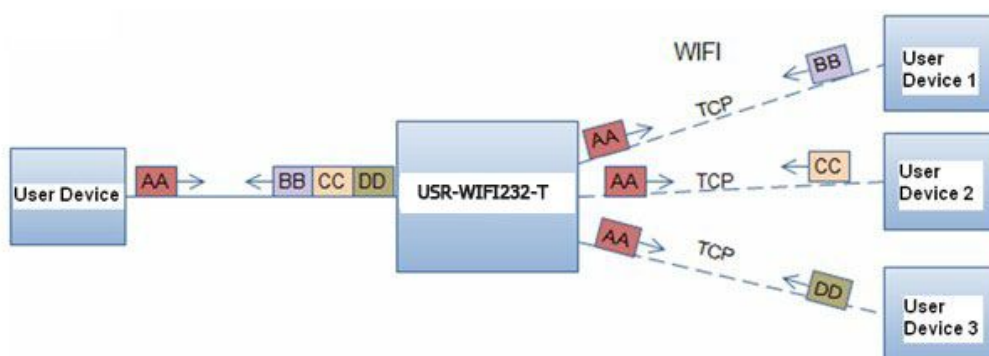

Figure 10. Multi-TCP Link Data Transmission Structure



### 3. OPERATION GUIDELINE

#### 3.1. Configuration via Web Accessing

When first use USR-WIFI232-T modules, user may need some configuration. User can connect to USR-WIFI232-T module’s wireless interface with following default setting information and configure the module through laptop.

Table 8 USR-WIFI232-T Web Access Default Setting

Parameters	Default Setting
SSID	HF-LPB100
IP Address	10.10.100.254
Subnet Mask	255.255.255.0
User Name	Admin
Password	Admin

##### 3.1.1. Open Web Management Interface

Step 1: Connect laptop to SSID “USR-WIFI232-T” of USR-WIFI232-T module via wireless LAN card;

Step 2: After wireless connection OK. Open Wen browser and access “<http://10.10.100.254>”;

Step 3: Then input user name and password in the page as following and click “OK” button.



Figure 11. Open Web Management page

The USR-WIFI232-T web management page support English and Chinese language. User can select language environment at the top right corner and click “Apply” button.

The main menu include nine pages: "System", "Work Mode", "STA Setting", "AP Setting", "Other Setting", "Account", "Upgrade SW", "Restart", "Restore".

### 3.1.2. System Page

At this page, user can check current device's important information and status such as: device ID (MID), software version, wireless work mode and related Wi-Fi parameters.

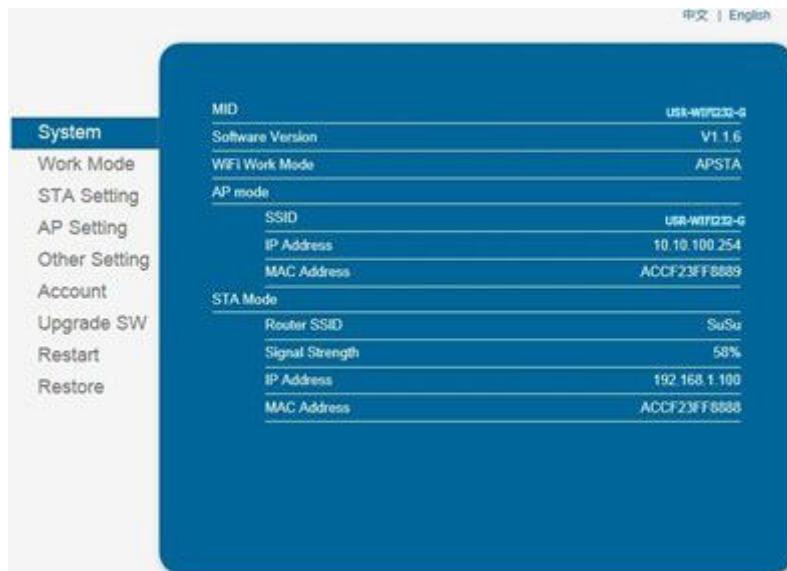

Figure 12. System Web Page

### 3.1.3. Work Mode Page

USR-WIFI232-T module can works at AP mode to simplify user's configuration, can also works at STA to connect remote server through AP router. Also, it can configure at AP+STA mode which provide very flexible application for customers.

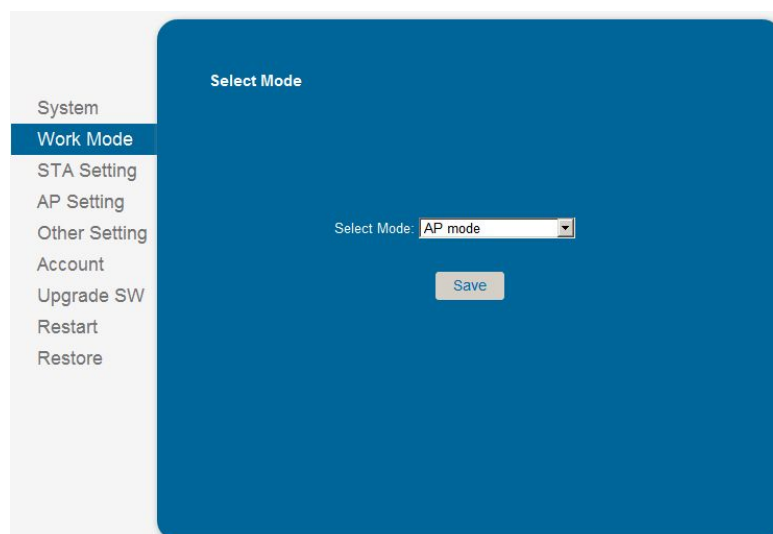

Figure 13. Work Mode Page

#### 3.1.4. STA Setting Page

User can push "Scan" button to auto search Wi-Fi AP router nearby, and can connect with associate AP through some settings. Please note the encryption information input here must be fully same with Wi-Fi AP router's configuration, and then it can link with AP correctly.



Figure 14. STA Setting Page

#### 3.1.5. AP Setting Page

When user select module works at AP and AP+STA mode, then need setting this page and provide wireless and network parameters. Most of the system support DHCP to achieve IP address, so we suggest to "Enable" DHCP server in most applications.

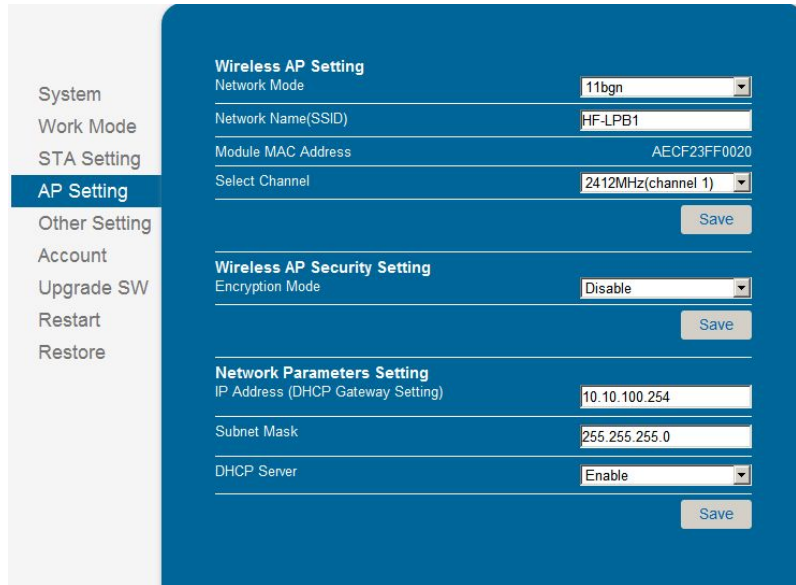

Figure 15. AP Setting Page

### 3.1.6. Other Setting Page

USR-WIFI232-T usually works at data transparent transmission mode. At this mode, the user device which connected with USR-WIFI232-T will connect and communicate with remote PC or server. At this page, user need setting serial port communication parameters and defines TCP related protocol parameters.

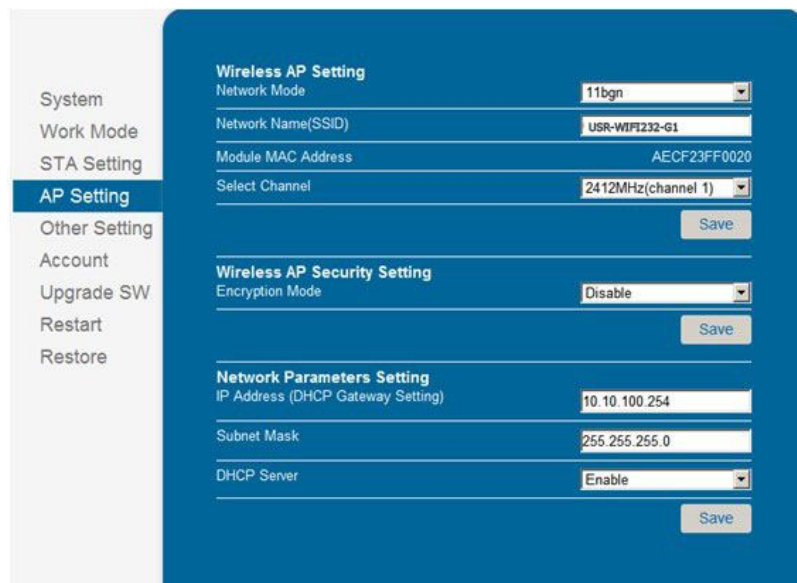
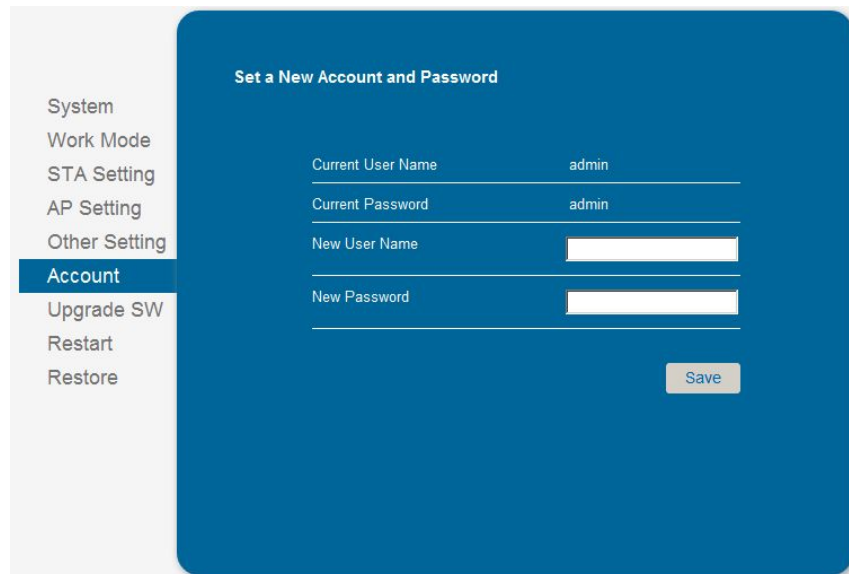

Figure 16. Other Setting Page

### 3.1.7. Account Management Page

This page set web server's user name and password.



The screenshot shows the 'Set a New Account and Password' page. On the left is a navigation menu with options: System, Work Mode, STA Setting, AP Setting, Other Setting, Account (highlighted), Upgrade SW, Restart, and Restore. The main content area has a title 'Set a New Account and Password' and four input fields: 'Current User Name' (admin), 'Current Password' (admin), 'New User Name' (empty), and 'New Password' (empty). A 'Save' button is located at the bottom right of the form.

Figure 17. Account Page

### 3.1.8. Upgrade Software Page

User can upgrade new software (firmware) version through Wi-Fi.

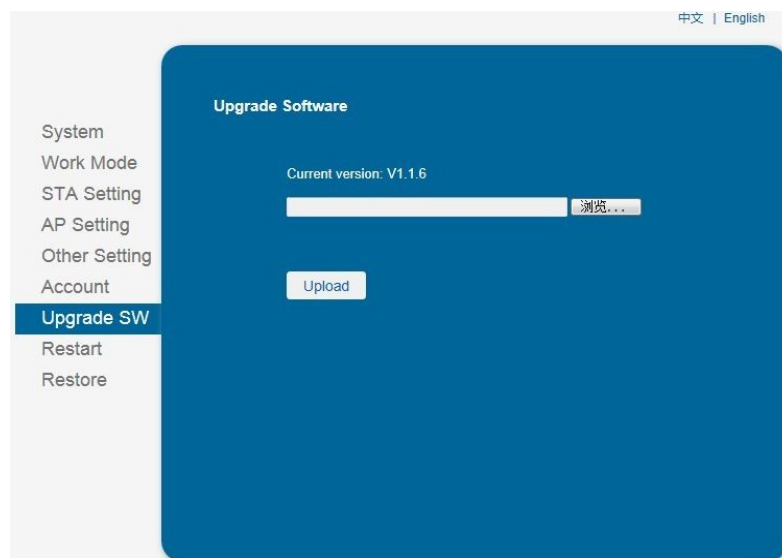

The screenshot shows the 'Upgrade Software' page. On the left is a navigation menu with options: System, Work Mode, STA Setting, AP Setting, Other Setting, Account, Upgrade SW (highlighted), Restart, and Restore. The main content area has a title 'Upgrade Software' and shows 'Current version: V1.1.6'. Below this is a file selection area with a text box and a '浏览...' button. An 'Upload' button is located below the file selection area. In the top right corner, there are language options: '中文 | English'.

Figure 18. Upgrade SW page

### 3.1.9. Restart Page

Most of the setting and configuration can only effective after system restart. User shall restart after finish all setting.

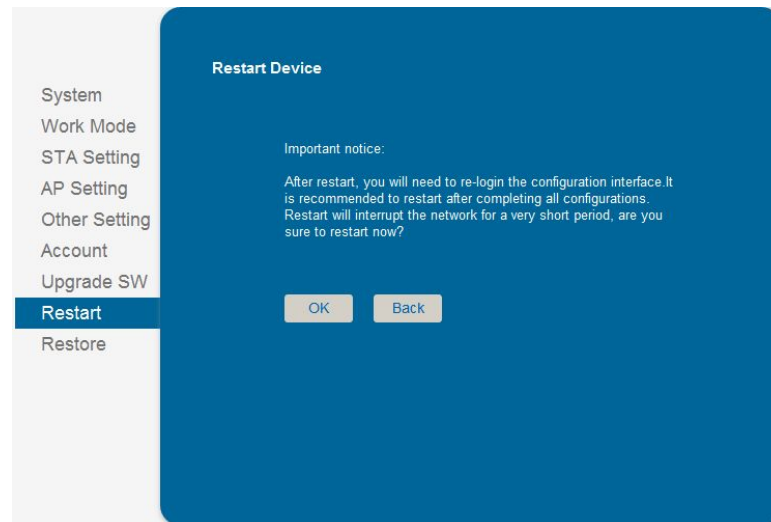

Figure 19. Restart Page

### 3.1.10. Restore Page

After module restore factory default setting, all user configuration profile will lose.

User can access <http://10.10.100.254> to set again, and user name and password is "admin". USR-WIFI232-T will restore to AP mode for factory default setting.

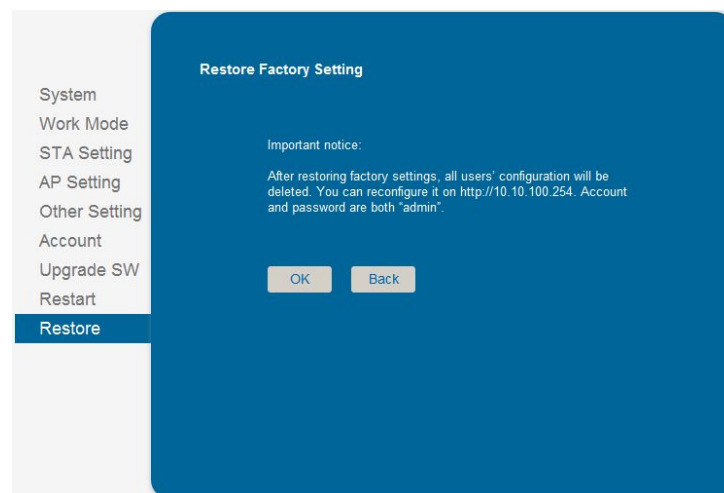



Figure 20. Restore Page

### 3.2. USR-WIFI232-T Usage Introduction

#### 3.2.1. Software Debug Tools

USR Technology use two common software tools debugging and applying USR-WIFI232-T module.

(User can also select other tools used to debug serial port).

- Serial Debugging Software: ComTools 
- Ethernet Debugging Software: TCPUDPDbg 

#### 3.2.2. Network Connection

User can select two methods to connect USR-WIFI232-T module base on dedicated application.

- **Use USR-WIFI232-T STA interface.** USR-WIFI232-T and debug PC2 connect to a wireless AP, another PC1 (or user device) connect to USR-WIFI232-T module with serial port:



Figure 21. STA Interface Debug Connection

- **Use USR-WIFI232-T AP interface.** Debug PC2 connect to USR-WIFI232-T through wireless connection, another PC1 (or user device) connect to USR-WIFI232-T module with serial port.



Figure 22. AP Interface Debug Connection

#### 3.2.3. Default Parameter Setting

- Default SSID: HF-LPB100;
- Deault security mode: open,none;
- User UART parameter setting:115200,8,1,None;
- Default network parameter setting:TCP,Server,8899,10.10.100.254;
- Module IP address: dhcp,0.0.0.0,0.0.0.0,0.0.0.0;

### 3.2.4. Module Debug

PC1 open "CommTools" program, setting the same serial port parameters with USR-WIFI232-T module and open serial port connection.

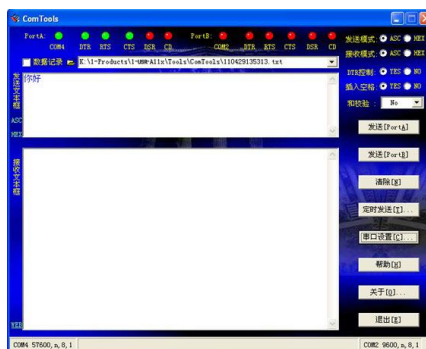

Figure 23. "CommTools" Serial Debug Tools

PC2 open "TCPUDPDbg" program, and create a new connection. If USR-WIFI232-T configured as Server mode, "TCPUDPDbg" Tools shall create "Client" mode connection. Or otherwise, create a "Server" mode connection.

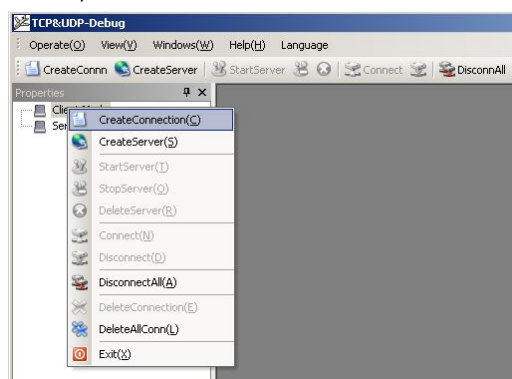

Figure 24. "TCPUDPDbg" Tools Create Connection

Then setting the TCP/UDP connection parameters. Default as following:

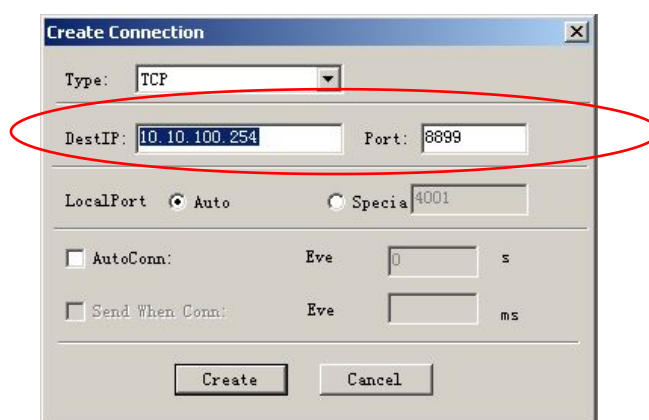

Figure 25. "TCPUDPDbg" Tools Setting

Then, click "Create" button to create a connection.



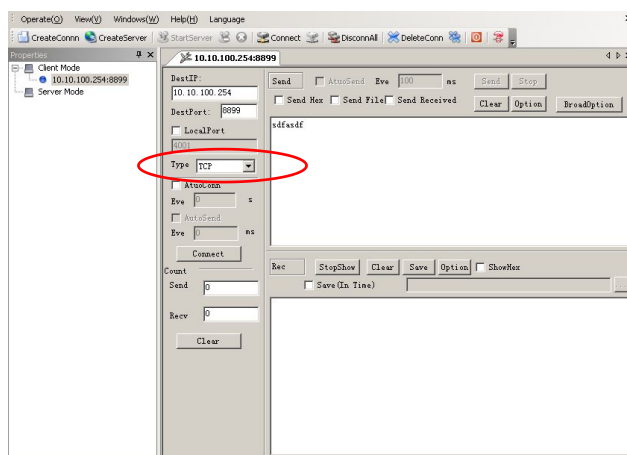

Figure 26. "TCPUDPDbg" Tools Connection

Now, in transparent transmission mode, data can be transferred from "CommTools" program to "TCPUDPDbg" program, or in reverse. You can see data in receiver side will keep same as in sender side.

### 3.3. Typical Application Examples

#### 3.3.1. Wireless Control Application



Figure 27. Wireless Control Application

For this wireless control application, USB-WIFI232-T works as Ad-Hoc mode. Module's serial port connects to user device. So, control agent (Smart phone for this example) can manage and control the user device through the wireless connection with USB-WIFI232-T module.

3.3.2. Remote Management Application

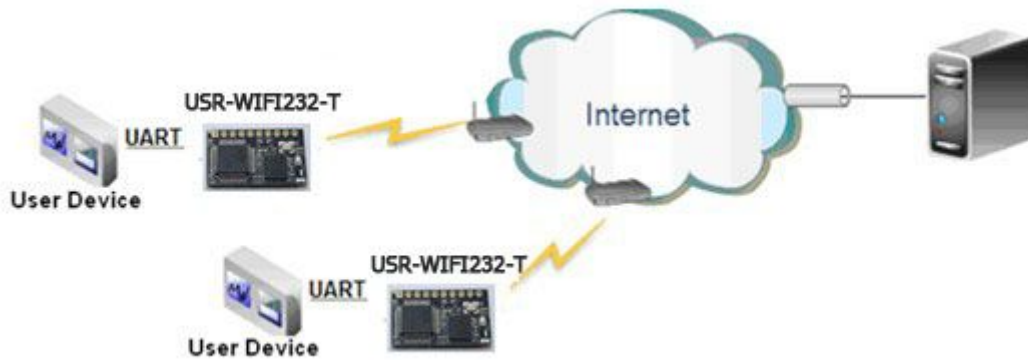

Figure 28. Remote Management Application

For this remote management application, USR-WIFI232-T works as STA mode and connects to Internet through wireless AP. Module configured as TCP Client and communicates with remote TCP server at Internet. Module's serial port connects to user device.

So, user device's data or sampling information can send to remote TCP server for storage or processing. Also remote TCP server can send command to control and manage the user device through the wireless network.

3.3.3. Transparent Serial Port Application

For this transparent serial port application, two USR-WIFI232-T modules connect as below figures to build up a transparent serial port connection. USR-WIFI232-T works as Ad-Hoc mode to connect each other.



Figure 29. Transparent Serial Port Application

## 4. AT+INSTRUCTION INTRODUCTION

### 4.1. Configuration Mode

When USR-WIFI232-T power up, it will default works as transparent transmission mode, then user can switch to configuration mode by serial port command. USR-WIFI232-T UART default parameters setting as below figure,

Uart Setting	
Baudrate	115200
Data Bits	8
Parity	None
Stop	1
CTSRTS	Disable

Figure 30. USR-WIFI232-T Default UART Port Parameters

In configuration mode, user can setting the module through AT+ instruction set, which cover all web page setting function.

#### 4.1.1. Switch to Configuration Mode

Two steps to finish switching from transparent transmission mode to configuration mode.

- **UART input "+++", after module receive "+++", and feedback "a" as confirmation.**
- **UART input "a", after module receive "a" and feedback "+ok" to go into AT+ instruction set configuration mode.**

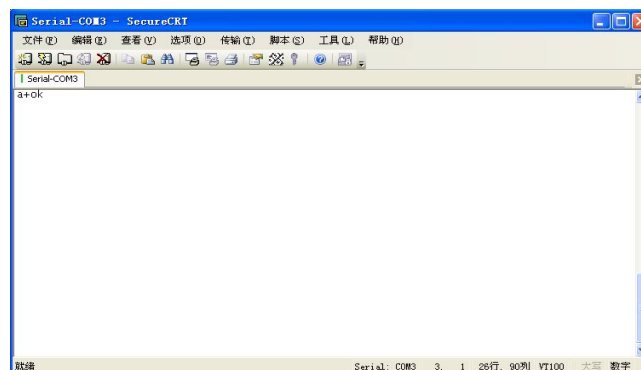

Figure 31. Switch to Configuration Mode

#### **Notes:**

1. When user input "+++" (No "Enter" key required), the UART port will display feedback information "a", and not display input information "+++" as above UART display.
2. Any other input or wrong step to UART port will cause the module still works as original mode (transparent transmission).

## 4.2. AT+ Instruction Set Overview

User can input AT+ Instruction through hyper terminal or other serial debug terminal, also can program the AT+ Instruction to script. User can also input "AT+H" to list all AT+ Instruction and description to start.

```

AT+H
+ok

AT+: NONE command, reply "+ok".
AT+ASWD: Set/Query WiFi configuration code.
AT+E: Echo ON/off, to turn on/off command line echo function.
AT+ENTM: Goto Through Mode.
AT+NETP: Set/Get the Net Protocol Parameters.
AT+UART: Set/Get the UART Parameters.
AT+UARTF: Enable/disable UART AutoFrame function.
AT+UARTFT: Set/Get time of UART AutoFrame.
AT+UARTFL: Set/Get frame length of UART AutoFrame.
AT+UARTTE: Set/Query UART free-frame triggerf time between two byte.
AT+PING: General PING command.
AT+WAP: Set/Get the AP parameters.
AT+WKEY: Set/Get the Security Parameters of WIFI AP Mode.
AT+WMODE: Set/Get the WIFI Operation Mode (AP or STA).
AT+WSKEY: Set/Get the Security Parameters of WIFI STA Mode.
AT+WSSID: Set/Get the AP's SSID of WIFI STA Mode.
AT+WSLK: Get Link Status of the Module (Only for STA Mode).
AT+WSLQ: Get Link Quality of the Module (Only for STA Mode).
AT+WSCAN: Get The AP site Survey (only for STA Mode).
AT+WEBU: Set/Get the Login Parameters of WEB page.
AT+TCPK: Get The state of TCP link.
AT+TCPTO: Set/Get TCP time out.
AT+TCPDIS: Connect/Dis-connect the TCP client link
AT+RECV: Recv data from UART
AT+SEND: Send data to UART
AT+WANN: Set/Get The WAN setting if in STA mode.
AT+LANN: Set/Get The LAN setting if in ADHOC mode.
AT+RELD: Reload the default setting and reboot.
AT+RLDEN: Put on/off the GPIO12.
AT+Z: Reset the Module.
AT+MID: Get The Module ID.
AT+VER: Get application version.
AT+H: Help.
    
```

Figure 32. "AT+H" Instruction for Help

### 4.2.1. Instruction Syntax Format

AT+Instruction protocol is based on the instruction of ASCII command style, the description of syntax format as follow.

#### ➤ Format Description

- < >: Means the parts must be included
- [ ]: Means the optional part

#### ➤ Command Message

**AT+<CMD>[op] [para-1, para-2, para-3, para-4...]<CR>**

- AT+: Prefix of command message;
- CMD: Command string;
- [op]: Symbol of command operator,
  - ◆ "=" : The command requires parameters input;
  - ◆ "NULL": Query the current command parameters setting;
- [para-n]: Parameters input for setting if required;
- <CR>:"Enter" Key, it's 0x0a or 0x0d in ASCII;

**Notes:** When input AT+Instruction, "AT+<CMD>" character will display capital letter automatic and other\_parts will not change as you input.

➤ **Response Message**

**+<RSP>[op] [para-1,para-2,para-3,para-4...]<CR><LF><CR><LF>**

- +: Prefix of response message;
- RSP: Response string;
  - ◆ "ok" : Success
  - ◆ "ERR": Failure
- [op] : =
- [para-n]: Parameters if query command or Error code when error happened;
- <CR>: ASCII 0x0d;
- <LF>: ASCII 0x0a;

➤ **Error Code**

Table 9 Error Code Description

Error Code	Description
-1	Invalid Command Format
-2	Invalid Command
-3	Invalid Operation Symbol
-4	Invalid Parameter
-5	Operation Not Permitted

4.2.2. AT+ Instruction Set

Table 10 AT+ Instruction Set List

Instruction	Description
<null>	NULL
<b>Management Instruction Set</b>	
E	Open/Close show back function
WMODE	Set/Query Wi-Fi work mode (AP/STA/APSTA)
ENTM	Set module into transparent transition mode
TMODE	Set/Query module data transfer mode
MID	Query module ID information
VER	Query module software version information
RELD	Restore to factory default setting
FCLR	Erase factory setting
Z	Re-start module
H	Help
<b>Configure Parameters Instruction Set</b>	
CFGRD	Batch Read User Configure Parameters
CFGWR	Batch Write Configure Parameters

CFGFR	Batch Read Factory Default Configure Parameters
CFGTF	Copy User Parameters to Factory Default Parameters
<b>UART Instruction Set</b>	
UART	Set/Query serial port parameters
UARTFT	Open/Close UART auto-frame function
UARTFTT	Set/Query UART auto-frame trigger time
UARTFL	Set/Query UART auto-frame trigger length
UARTTE	Set/Query UART free-frame trigger time between two bytes
<b>Command Mode Set</b>	
SEND	Send Data at Command Mode
RECV	Receive Data at Command Mode
<b>Network Instruction Set</b>	
PING	Network "Ping" Instruction
NETP	Set/Query network protocol parameters
MAXSK	Set/Query TCP Client connection number
TCPLK	Query if TCP link already build-up
TCPTO	Set/Query TCP timeout
TCPDIS	Open/Close TCP link
SOCKB	Set/Query SOCKB parameters
TCPDISB	Open/Close SOCKB TCP link
TCPTOB	Set/Query SOCKB TCP timeout
TCPLKB	Query if SOCKB TCP link already build-up
SNDB	Send data to SOCKB in Command Mode
RCVB	Receive data from SOCKB in Command Mode
<b>Wi-Fi STA Instruction Set (Effective when module works as STA)</b>	
WSKEY	Set/Query STA security parameters
WSSID	Set/Query associated AP SSID parameters
WANN	Set/Query STA's network parameters
WSMAC	Set/Query STA's MAC address
WSLK	Query STA Wi-Fi link status
WSLQ	Query STA Wi-Fi signal strength
WSCAN	Scan AP
WSDNS	Set/Query STA's Static DNS server address
<b>Wi-Fi AP Instruction Set (Effective when module works as AP)</b>	
LANN	Set/Query AP's network parameters
WAP	Set/Query AP Wi-Fi parameters
WAKEY	Set/Query AP security parameters
WAMAC	Set/Query AP MAC address
WADHCP	Set/Query AP DHCP Server status
WADMN	Set/Query AP webpage domain name
<b>Webpage Management Instruction Set</b>	
PLANG	Set/Query Webpage Language Option
WEBU	Set/Query Webpage User name and Code
<b>Remote Upgrade Instruction Set</b>	
UPURL	Set/Query remote upgrade URL address

UPFILE	Set/Query remote upgrade configure file name
UPWEB	Start remote web upgrade
UPCFG	Start remote config file upgrade
UPNVR	Start remote NVRAM data upgrade
UPAUTO	Start remote upgrade
LOGSW	Open/Close remote upgrade log
LOGPORT	Set/Query UDP port of remote upgrade log
UPST	Start remote Application upgrade
<b>Power Management Instruction Set</b>	
MSLP	Set/Query deep sleep/standby mode parameters
<b>Network Time Set</b>	
NTPRF	Set/Query time calibration interval
NTPEN	Enable/Disable time calibration function
NTPTM	Query time
<b>Others Instruction Set</b>	
WRMID	Set module ID
RLDEN	Set/Query GPIO45 status
ASWD	Set/Query WiFi configuration code
MDCH	Set Wi-Fi Auto Switch Function
TXPWR	Set/Query Wi-Fi Transmit Power
LPTIO	Enable/Disable nReady, nLink function

**WIFI Config Tools don't support "CFGRD" command yet.**

4.2.2.1. AT+E

- Function: Open/Close show back function;
- Format:

**AT+E<CR>**

**+ok<CR>< LF ><CR>< LF >**

When USR-WIFI232-T module firstly switch from transparent transmission to configuration mode, show back status is open, input "AT+E" to close show back function, input"AT+E" again to open show back function.

4.2.2.2. AT+WMODE

- Function: Set/Query WIFI work mode;
- Format:

◆ Query Operation

**AT+WMODE<CR>**

**+ok=<mode><CR>< LF ><CR>< LF >**

◆ Set Operation

**AT+ WMODE=<mode><CR>**

**+ok<CR>< LF ><CR>< LF >**

- Parameters:

◆ mode:Wi-Fi work mode

- ◇ AP
- ◇ STA
- ◇ APSTA

## 4.2.2.3. AT+ENTM

- Function: Set module into transparent transmission mode;
- Format:

```
AT+ENTM<CR>
```

```
+ok<CR>< LF ><CR>< LF >
```

When operate this command, module switch from configuration mode to transparent transmission mode.

## 4.2.2.4. AT+TMODE

- Function: Set/Query module data transfer mode.
- Format:

- ◆ Query Operation

```
AT+TMODE<CR>
```

```
+ok=<tmode><CR>< LF ><CR>< LF >
```

- ◆ Set Operation

```
AT+TMODE=<tmode><CR>
```

```
+ok<CR>< LF ><CR>< LF >
```

- Parameters:
  - ◆ tmode: data transfer mode, include:
    - ◇ throughput
    - ◇ cmd
    - ◇ pwm

## 4.2.2.5. AT+MID

- Function: Query module ID information;
- Format:
  - ◆ Query Operation

```
AT+MID<CR>
```

```
+ok=<module_id><CR>< LF ><CR>< LF >
```

- Parameters:
  - ◆ module\_id: Module ID information;
    - ◇ USR-WIFI232-T;

Notes: User can set this parameter through AT+WRMID.

## 4.2.2.6. AT+VER

- Function: Query module software version information;
- Format:
  - ◆ Query Operation

```
AT+VER<CR>
```

```
+ok=<ver><CR>< LF ><CR>< LF >
```

- Parameters:
  - ◆ ver: Module software version information;



## 4.2.2.7. AT+RELD

- Function: module restore to factory default setting;
- Format:
  - ◆ Set Operation

```
AT+RELD<CR>
```

```
+ok=rebooting...<CR><LF><CR><LF>
```

When operate this command, module will restore to factory default setting and reboot.

## 4.2.2.8. AT+FCLR

- Function: Erase factory setting;
- Format:
  - ◆ Query Operation

```
AT+FCLR<CR>
```

```
+ok=<status><CR><LF><CR><LF>
```

## 4.2.2.9. AT+Z

- Function: Re-start module;
- Format:

```
AT+Z<CR>
```

## 4.2.2.10. AT+H

- Function: Help;
- Format:
  - ◆ Query Operation

```
AT+H<CR>
```

```
+ok=<command help><CR><LF><CR><LF>
```

- Parameters:
  - ◆ command help: command introduction;

## 4.2.2.11. AT+CFGRD

- Function: Batch Read User Configure Parameters;
- Format:
  - ◆ Query Operation

```
AT+CFGRD<CR>
```

```
+ok=<config><CR><LF><CR><LF>
```

- Parameters:
  - ◆ config: the first two bytes means the length of configuration parameters;

## 4.2.2.12. AT+CFGWR

- Function: Batch Write User Configure Parameters;
- Format:
  - ◆ Set Operation

```
AT+CFGWR=<config><CR>
```

```
+ok<CR>< LF ><CR>< LF >
```

- Parameters:
  - ◆ config: the first two bytes means the length of configuration parameters;

#### 4.2.2.13. AT+CFGFR

- Function: Batch Read Factory Default Configure Parameters;
- Format:
  - ◆ Query Operation

```
AT+CFGFR<CR>
```

```
+ok=<config><CR>< LF ><CR>< LF >
```

- Parameters:
  - ◆ config: the first two bytes means the length of configuration parameters;

#### 4.2.2.14. AT+CFGTF

- Function: Copy User Parameters to Factory Default Parameters;
- Format:
  - ◆ Query Operation

```
AT+CFGTF<CR>
```

```
+ok=<status><CR>< LF ><CR>< LF >
```

- Parameters:
  - ◆ status: feedback operation status;

#### 4.2.2.15. AT+UART

- Function: Set/Query serial port parameters;
- Format:
  - ◆ Query Operation

```
AT+UART<CR>
```

```
+ok=<baudrate,data_bits,stop_bit,parity><CR>< LF ><CR>< LF >
```

- ◆ Set Operation

```
AT+UART=<baudrate,data_bits,stop_bit,parity><CR>
```

```
+ok<CR>< LF ><CR>< LF >
```

- Parameters:
  - ◆ baudrate:
    - ◇ 300,600,1200,1800,2400,4800,9600,19200,38400,57600,115200,230400,380400,460800.
  - ◆ data\_bits:
    - ◇ 8
  - ◆ stop\_bits:
    - ◇ 1,2
  - ◆ parity:

- ◇ NONE
- ◇ EVEN
- ◇ ODD
- ◆ Flowctrl: (CTSRTS)
  - ◇ NFC: No hardware flow control
  - ◇ FC: hardware flow control

#### 4.2.2.16. AT+ UARTF

- Function: Open/Close UART auto-frame function;

- Format:

- ◆ Query Operation

```
AT+ UARTF<CR>
```

```
+ok=<para><CR>< LF ><CR>< LF >
```

- ◆ Set Operation

```
AT+ UARTF=<para ><CR>
```

```
+ok<CR>< LF ><CR>< LF >
```

- Parameters:

- ◆ para:

- ◇ disable - Close auto-frame function;
- ◇ enable - Open auto-frame function;

#### 4.2.2.17. AT+ UARTFT

- Function: Set/Query UART auto-frame trigger time;

- Format:

- ◆ Query Operation

```
AT+ UARTFT<CR>
```

```
+ok=<time><CR>< LF ><CR>< LF >
```

- ◆ Set Operation

```
AT+ UARTFT=<time ><CR>
```

```
+ok<CR>< LF ><CR>< LF >
```

- Parameters:

- ◆ time: Range 100 ~10000; Unit: ms. Auto-frame trigger time

#### 4.2.2.18. AT+ UARTFL

- Function: Set/Query UART auto-frame trigger length;

- Format:

- ◆ Query Operation

```
AT+ UARTFL<CR>
```

```
+ok=<len><CR>< LF ><CR>< LF >
```

- ◆ Set Operation

```
AT+ UARTFL=<len ><CR>
```

```
+ok<CR>< LF ><CR>< LF >
```

- Parameters:

- ◆ len: Range 8 ~1000; Unit: Byte. Auto-frame trigger length;

## 4.2.2.19. AT+ UARTTE

- Function: Set/Query UART free-frame trigger time between two bytes;
- Format:
  - ◆ Query Operation  
**AT+ UARTTE<CR>**  
**+ok=<mode><CR>< LF ><CR>< LF >**
  - ◆ Set Operation  
**AT+ UARTTE=<mode><CR>**  
**+ok<CR>< LF ><CR>< LF >**
- Parameters:
  - ◆ mode:
    - ◇ fast: free-frame trigger time between two bytes is 10ms;
    - ◇ normal: free-frame trigger time between two bytes is 50ms;

## 4.2.2.20. AT+ SEND

- Function: Send Data at Command Mode.
- Format:  
**AT+SEND=<data\_lenth><CR>**  
**+ok<CR>< LF ><CR>< LF >**
- Parameters:
  - ◆ data\_lenth: Lenth of send data. Range: 0~1000 Byte

The UART port will wait 3 seconds for input after this command is sent OK. The data received from UART port is sent to socket. If the interval of two bytes is more than 10ms, the data will be sent instantly.

## 4.2.2.21. AT+ RECV

- Function: Receive Data at Command Mode.
  - Format:  
**AT+RECV=<data\_lenth><CR>**  
**+ok=< data\_lenth, data\_content><CR>< LF ><CR>< LF >**
  - Parameters:
    - ◆ data\_lenth: Lenth of receive data. Range: 0~1000 Byte
    - ◆ data\_content: contents of receive data.
- If not receive any data in 3 second, then feedback +ok=0.

## 4.2.2.22. AT+ PING

- Function: Network "PING" Instruction.
- Format:
  - ◆ Set Operation  
**AT+ PING=<IP\_address ><CR>**  
**+ok=<sta><CR>< LF ><CR>< LF >**
- Parameters:
  - ◆ sta: feedback result

- ◇ Success
- ◇ Timeout
- ◇ Unknown host

#### 4.2.2.23. AT+NETP

- Function: Set/Query network protocol parameters;
- Format:
  - ◆ Query Operation

**AT+NETP<CR>**

**+ok=<protocol,CS,port,IP><CR>< LF ><CR>< LF >**

- ◆ Set Operation

**AT+NETP=<protocol,CS,port,IP><CR>**

**+ok<CR>< LF ><CR>< LF >**

- Parameters:

- ◆ protocol:

- ◇ TCP
- ◇ UDP

- ◆ CS: Network mode:

- ◇ SERVER
- ◇ CLIENT

- ◆ Port: protocol port ID: Decimal digit and less than 65535

- ◆ IP: Server's IP address when module set as client

If set as UDP SERVER, the module will save the IP address and port of the latest UDP packet received. The data will be sent to the saved IP address and port. If the module hasn't saved any IP address and port when power up. The data will be sent to the IP address and port which is set by this command.

If set as UDP,CLIENT, the data will always be sent to the IP address and port set by this command.

#### 4.2.2.24. AT+ MAXSK

- Function: Set/ Query TCP Client connection number.
- Format:
  - ◆ Query Operation

**AT+MAXSK<CR>**

**+ok=<num><CR>< LF ><CR>< LF >**

- ◆ Set Operation

**AT+MAXSK=<num><CR>**

**+ok<CR>< LF ><CR>< LF >**

- Parameters:

- ◆ num: TCP Client connection number. Range: 1~5. 5 is the default value it means when the module work in TCP server , it accepts max 5 TCP client connect to it.

## 4.2.2.25. AT+ TCPLK

- Function: Query if TCP link already build-up;
- Format:

```
AT+ TCPLK<CR>
```

```
+ok=<sta><CR>< LF ><CR>< LF >
```

- Parameters:
  - ◆ sta.: if module already setup TCP link;
    - ◇ on: TCP link setup;
    - ◇ off: TCP link not setup;

## 4.2.2.26. AT+ TCPTO

- Function: Set/Query TCP timeout;
- Format:

- ◆ Query Operation

```
AT+ TCPTO<CR>
```

```
+ok=<time><CR>< LF ><CR>< LF >
```

- ◆ Set Operation

```
AT+ TCPTO=<time ><CR>
```

```
+ok<CR>< LF ><CR>< LF >
```

- Parameters:
  - ◆ time: TCP timeout time.
    - ◇ ≤ 600, (600s);
    - ◇ ≥ 0, (0 means no timeout);
    - ◇ Default, 300s;

## 4.2.2.27. AT+TCPDIS

- Function: Open/Close TCP link;
- Format:

- ◆ Query Opera

```
AT+TCPDIS<CR>
```

```
+ok=<sta><CR>< LF ><CR>< LF >
```

- ◆ Set Operation

```
AT+ TCPDIS =<on/off><CR>
```

```
+ok<CR>< LF ><CR>< LF >
```

- Parameters:

When query, sta.: Feedback if TCP Client can be link,

- ◇ On, TCP link close
- ◇ off, TCP link on

When setting, "off" means close TCP link. After finish this command, module disconnect TCP link and not connect again. "On" means open TCP link. After finish this command, module re-connect TCP server right away.

## 4.2.2.28. AT+SOCKB

- Function: Set/Query SOCKB parameters
  - Format:
    - ◆ Query Operation
- ```
AT+SOCKB<CR>  
+ok=<protocol,port,IP><CR>< LF ><CR>< LF >
```
- ◆ Set Operation
- ```
AT+SOCKB=<protocol,port,IP><CR>  
+ok<CR>< LF ><CR>< LF >
```
- Parameters:
    - ◆ Protocol: Protocol type:
      - ◇ TCP: Only for TCP Client
      - ◇ UDP
    - ◆ Port: Protocol Port in decimal, less than 65535
    - ◆ IP: Destination IP address, domain name is support

## 4.2.2.29. AT+TCPDISB

- Function: Open/Close TCP\_B connection
- Format:
  - ◆ Query Operation

```
AT+TCPDISB<CR>
```

```
+ok=<sta><CR>< LF ><CR>< LF >
```

- ◆ Set Operation

```
AT+ TCPDISB =<on/off><CR>
```

```
+ok<CR>< LF ><CR>< LF >
```

- Parameters:

When setting, "off" means close TCP link. After finish this command, module disconnect TCP link and not connect again. "On" means open TCP link. After finish this command, module re-connect TCP server right away.

## 4.2.2.30. AT+TCPTOB

- Function: Set/Query OperationTCP\_B timeout
- Format:
  - ◆ Query Operation

```
AT+ TCPTOB<CR>
```

```
+ok=<time><CR>< LF ><CR>< LF >
```

- ◆ Set Operation

```
AT+ TCPTOB=<time ><CR>
```

```
+ok<CR>< LF ><CR>< LF >
```

- Parameters

- ◆ Time: TCP timeout
  - ◇ ≤ 600:600s
  - ◇ ≥ 0:0 means no timeout

◇ Default:300s

The module will not connect TCP\_B after TCP timeout. The module will make connection after another "TCPDIS" command.

#### 4.2.2.31. AT+TCPLKB

- Function:Query TCP\_B connection status
- Format:  
**AT+ TCPLKB<CR>**  
**+ok=<sta><CR>< LF ><CR>< LF >**
- Parameters:
  - ◆ sta.: TCP\_B connection status
    - ◇ on: TCP connected
    - ◇ off: TCP disconnected

#### 4.2.2.32. AT+SNDB

- Function: Send datas to SOCKB at Command Mode
- Format:  
**AT+SNDB=<data\_lenth ><CR>**  
**+ok<CR>< LF ><CR>< LF >**
- Parameters:
  - ◆ data\_lenth: Lenth of send data. Range: 0~1000 Byte

The UART port will wait 3 seconds for input after this command is sent OK. The data received from UART port is sent to socket. If the interval of two bytes is more than 10ms, the data will be sent instantly.

#### 4.2.2.33. AT+RCVB

- Function: Receive datas from SOCKB at Command Mode
  - Format:  
**AT+RCVB=<data\_lenth><CR>**  
**+ok=< data\_lenth, data\_content><CR>< LF ><CR>< LF >**
  - Parameters:
    - ◆ data\_lenth: Lenth of receive data. Range: 0~1000 Byte
    - ◆ data\_content: contents of receive data.
- If not receive any data in 3 second, then feedback +ok=0.

#### 4.2.2.34. AT+WSSSID

- Function: Set/Query Wi-Fi associated AP SSID parameters.
- Format:
  - ◆ Query Operation  
**AT+WSSSID<CR>**  
**+ok=<ap's ssid><CR>< LF ><CR>< LF >**
  - ◆ Set Operation  
**AT+ WSSSID=<ap's ssid ><CR>**



```
+ok<CR>< LF ><CR>< LF >
```

- Parameters:
  - ◆ ap's ssid: AP's SSID (Within 32 character);

#### 4.2.2.35. AT+WSKEY

- Function: Set/Query STA security parameters;
- Format:
  - ◆ Query Operation

```
AT+WSKEY<CR>
```

```
+ok=<auth, encry, key><CR>< LF ><CR>< LF >
```

- ◆ Set Operation

```
AT+ WSKEY=< auth, encry, key><CR>
```

```
+ok<CR>< LF ><CR>< LF >
```

- Parameters:
  - ◆ auth: Authentication mode
    - ◇ OPEN
    - ◇ SHARED
    - ◇ WPAPSK
    - ◇ WPA2PSK
  - ◆ encry: Encryption algorithm
    - ◇ NONE: When "auth=OPEN", effective
    - ◇ WEP: When "auth=OPEN" or "SHARED", effective
    - ◇ TKIP: When "auth= WPAPSK" or "WPA2PSK", effective
    - ◇ AES: When "auth= WPAPSK" "WPA2PSK", effective
  - ◆ key: password, ASCII code, shall less than 64 bit and greater than 8bit

#### 4.2.2.36. AT+ WANN

- Function: Set/Query STA network setting;
- Format:
  - ◆ Query Operation

```
AT+WANN<CR>
```

```
+ok=<mode, address, mask, gateway><CR>< LF ><CR>< LF >
```

- ◆ Set Operation

```
AT+ WANN=< mode, address, mask, gateway ><CR>
```

```
+ok<CR>< LF ><CR>< LF >
```

- Parameters:
  - ◆ mode: STA's IP network setting
    - ◇ static: Static IP
    - ◇ DHCP: Dynamic IP
  - ◆ address: STA IP address;
  - ◆ mask: STA subnet mask;
  - ◆ gateway: STA gateway address;

## 4.2.2.37. AT+ WSMAC

- Function: Set/Query STA MAC address parameters;
- Format:
  - ◆ Query Operation  
**AT+WSMAC<CR>**  
**+ok=<mac\_address><CR>< LF ><CR>< LF >**
  - ◆ Set Operation  
**AT+ WSMAC=<code,mac\_address><CR>**  
**+ok<CR>< LF ><CR>< LF >**
- Parameters:
  - ◆ code: security code
    - ◇ 8888 (default value)
  - ◆ Mac\_address: STA MAC address, such as ACCF23FF1234

## 4.2.2.38. AT+ WSLK

- Function: Query STA WiFi link status
- Format:
  - ◆ Query Operation  
**AT+ WSLK<CR>**  
**+ok=<ret><CR>< LF ><CR>< LF >**
- Parameters:
  - ◆ ret
    - ◇ "Disconnected", if no WiFi connection;
    - ◇ "AP' SSID (AP's MAC" ), if WiFi connection available;
    - ◇ "RF Off", if WiFi OFF;

## 4.2.2.39. AT+ WSLQ

- Function: Query STA WiFi signal strength;
- Format:
  - ◆ Query Operation  
**AT+ WSLQ<CR>**  
**+ok=<ret><CR>< LF ><CR>< LF >**
- Parameters:
  - ◆ ret
    - ◇ "Disconnected", if no WiFi connection;
    - ◇ "AP's WiFi signal strength" , if WiFi connection available;

## 4.2.2.40. AT+WSCAN

- Function: Scan AP;
- Format:
  - ◆ Query Operation  
**AT+ WSCAN<CR>**  
**+ok=<ap\_site><CR>< LF ><CR>< LF >**
- Parameters:

- ◆ ap\_site: AP searched;

## 4.2.2.41. AT+ WSDNS

- Function: Set/Query STA static DNS server address;
- Format:
  - ◆ Query Operation  
**AT+WSDNS<CR>**  
**+ok=<address><CR>< LF ><CR>< LF >**
  - ◆ Set Operation  
**AT+ WSDNS =<address><CR>**  
**+ok<CR>< LF ><CR>< LF >**
- Parameters:
  - ◆ address: STA's DNS server address; Effective right away.

## 4.2.2.42. AT+ LANN

- Function: Set/Query AP's network parameters;
- Format:
  - ◆ Query Operation  
**AT+LANN<CR>**  
**+ok=<ipaddress,mask><CR>< LF ><CR>< LF >**
  - ◆ Set Operation  
**AT+ LANN=< ipaddress,mask><CR>**  
**+ok<CR>< LF ><CR>< LF >**
- Parameters:
  - ◆ ipaddress: AP's IP address;
  - ◆ mask: AP's net mask;

## 4.2.2.43. AT+WAP

- Function: Set/Query AP Wi-Fi parameters;
- Format:
  - ◆ Query Operation  
**AT+WAP<CR>**  
**+ok=<wifi\_mode,ssid,channel><CR>< LF ><CR>< LF >**
  - ◆ Set Operation  
**AT+ WAP =<wifi\_mode,ssid,channel><CR>**  
**+ok<CR>< LF ><CR>< LF >**
- Parameters:
  - ◆ wifi\_mode: Wi-Fi mode, include:
    - ◇ 11B
    - ◇ 11BG
    - ◇ 11BGN (Default Value)
  - ◆ ssid:SSID at AP mode
  - ◆ channel: Wi-Fi channel selection:
    - ◇ AUTO

◇ CH1~CH11; (Default CH1)

#### 4.2.2.44. AT+WKEY

- Function: Set/Query AP Wi-Fi security parameters;
- Format:
  - ◆ Query Operation  
**AT+WKEY<CR>**  
**+ok=<auth, encry, key><CR>< LF ><CR>< LF >**
  - ◆ Set Operation  
**AT+ WKEY=< auth, encry, key><CR>**  
**+ok<CR>< LF ><CR>< LF >**
- Parameters:
  - ◆ auth: include
    - ◇ OPEN
    - ◇ WPA2PSK
  - ◆ Encry: include
    - ◇ NONE: When "auth=OPEN" available;
    - ◇ AES: When "auth=WPA2PSK" available;
  - ◆ key: security code, ASCII code, smaller than 64bit and bigger than 8 bit;

#### 4.2.2.45. AT+WAMAC

- Function: Query AP MAC address parameters;
- Format:
  - ◆ Query Operation  
**AT+WAMAC<CR>**  
**+ok=<mac\_address><CR>< LF ><CR>< LF >**
- Parameters:
  - ◆ mac\_address: AP's MAC address;

Note: Module AP mode's MAC address is related to STA mode's MAC address. If user need changeto others, please contact with USR Technology technical people.

#### 4.2.2.46. AT+WADHCP

- Function: Set/Query AP DHCP server status;
- Format:
  - ◆ Query Operation  
**AT+WADHCP<CR>**  
**+ok=<status><CR>< LF ><CR>< LF >**
  - ◆ Set Operation  
**AT+ WADHCP=<status><CR>**  
**+ok<CR>< LF ><CR>< LF >**
- Parameters:
  - ◆ status: AP's DHCP server function status:

- ✧ on:DHCP Server Open;
- ✧ off:DHCP Server Close:

## 4.2.2.47. AT+WADMN

- Function: Set/Query AP webpage domain name;
- Format:
  - ◆ Query Operation  
**AT+WADMN<CR>**  
**+ok=<domain\_name><CR>< LF ><CR>< LF >**
  - ◆ Set Operation  
**AT+ WADMN =<domain\_name><CR>**  
**+ok<CR>< LF ><CR>< LF >**
- Parameters:
  - ◆ Domain\_name: Webpage domain name (within 20 characters, can't all numbers).

## 4.2.2.48. AT+PLANG

- Function: Set/ Query webpage language option;
- Format:
  - ◆ Query Operation  
**AT+ PLANG<CR>**  
**+ok=<language> <CR>< LF ><CR>< LF >**
  - ◆ Set Operation  
**AT+ PLANG=<language> <CR>**  
**+ok<CR>< LF ><CR>< LF >**
- Parameters:
  - ◆ language: webpage's language
    - ✧ CN: Chinese Version (Default);
    - ✧ EN: English Version;

## 4.2.2.49. AT+UPURL

- Function: Set/ Query remote upgrade URL address;
- Format:
  - ◆ Query Operation  
**AT+ UPURL<CR>**  
**+ok=<url> <CR>< LF ><CR>< LF >**
  - ◆ Set Operation  
**AT+ UPURL=<url, filename> <CR>**  
**+ok<CR>< LF ><CR>< LF >**
- Parameters:
  - ◆ url: the upgrade file url address; the last charter shall be "/" (within 20 characters).
  - ◆ filename: the upgrade file name, it's optional and not saved parameter. If provide this file name here, the module will start upgrade right away;

## 4.2.2.50. AT+UPFILE

- Function: Set/ Query remote upgrade configure file name;
- Format:

- ◆ Query Operation

```
AT+ UPFILE<CR>
```

```
+ok=<filename> <CR>< LF ><CR>< LF >
```

- ◆ Set Operation

```
AT+ UPFILE=<filename> <CR>
```

```
+ok<CR>< LF ><CR>< LF >
```

- Parameters:
  - ◆ filename: the upgrade configure file name (within 20 characters).

## 4.2.2.51. AT+UPWEB

- Function: Remote webpage upgrade
- Format:
  - ◆ Query Operation

```
AT+UPWEB<CR>
```

```
+ok=<log><CR>< LF ><CR>< LF >
```

- Parameters:
  - ◆ log: Some status print log from remote upgrade.

**Note:** After execute this command, the USR-WIFI232-T will automatic start upgrade Webpage base on the setting of UPURL, UPFILE command contents;

## 4.2.2.52. AT+UPCFG

- Function: Remote factory setting upgrade
- Format:
  - ◆ Query Operation

```
AT+UPCFG<CR>
```

```
+ok=<log><CR>< LF ><CR>< LF >
```

- Parameters:
  - ◆ log: Some status print log from remote upgrade.

**Note:** After execute this command, the USR-WIFI232-T will automatic start upgrade base on the setting of UPURL, UPFILE command contents;

## 4.2.2.53. AT+UPNVR

- Function: Remote NVRAM data upgrade
- Format:
  - ◆ Query Operation

```
AT+UPNVR<CR>
```

```
+ok=<log><CR>< LF ><CR>< LF >
```

- Parameters:
  - ◆ log: Some status print log from remote upgrade.

**Note:** After execute this command, the USR-WIFI232-T will automatic start upgrade base on the setting of UPURL, UPFILE command contents;

## 4.2.2.54. AT+UPAUTO

- Function: Remote Application, Webpage, factory setting upgrade
- Format:
  - ◆ Query Operation

```
AT+UPAUTO<CR>
```

```
+ok=<log><CR>< LF ><CR>< LF >
```

- Parameters:
  - ◆ log: Some status print log from remote upgrade.

**Note:** After execute this command, the USR-WIFI232-T will automatic start upgrade Application, Webpage, factory setting base on the setting of UPURL, UPFILE command contents;

## 4.2.2.55. AT+LOGSW

- Function: Open/Close remote upgrade logfile
- Format:
  - ◆ Query Operation

```
AT+LOGSW<CR>
```

```
+ok=<status><CR>< LF ><CR>< LF >
```

- ◆ Set Operation

```
AT+LOGSW=<status><CR>
```

```
+ok<CR>< LF ><CR>< LF >
```

- Parameters:
  - ◆ status:
    - ✧ on: Open. The UART Port will print some upgrade status when upgrading. the log file will be sent to UDP Port after successfully
    - ✧ off: Close.

## 4.2.2.56. AT+LOGPORT

- Function: Set/Query remote upgrade UDP port of log file.
- Format:
  - ◆ Query Operation

```
AT+LOGPORT<CR>
```

```
+ok=<port><CR>< LF ><CR>< LF >
```

- ◆ Set Operatioin:

```
AT+ LOGPORT =<port><CR>
```

```
+ok<CR>< LF ><CR>< LF >
```

- Parameters:
  - ✧ port: The remote upgrade UDP port of log file.

## 4.2.2.57. AT+UPST

- Function: Start remote upgrade;
- Format:
  - ◆ Query Operation

```
AT+ UPST<CR>
```

```
+ok=<log> <CR>< LF ><CR>< LF >
```

- Parameters:

- ◆ log: feedback the status of remote upgrade;

**Note:** After execute this command, the USR-WIFI232-T will automatic start upgrade base on the setting of UPURL, UPFILE command contents;

#### 4.2.2.58. AT+WEBU

- Function: Set/ Query webpage user name and password;

- Format:

- ◆ Query Operation

```
AT+ WEBU<CR>
```

```
+ok=<username,password> <CR>< LF ><CR>< LF >
```

- ◆ Set Operation

```
AT+ WEBU=<username,password><CR>
```

```
+ok<CR>< LF ><CR>< LF >
```

- Parameters:

- ◆ username: User Name, within 15 characters, not support empty.
- ◆ password: password, within 15 characters, support empty.

#### 4.2.2.59. AT+MSLP

- Function: Set/Query deep sleep/standby mode parameters;

- Format:

- ◆ Query Operation

```
AT+ MSLP<CR>
```

```
+ok=<ret><CR>< LF ><CR>< LF >
```

- ◆ Set Operation

```
AT+ MSLP=<mode><CR>< LF ><CR>< LF >
```

- Parameters:

- ◆ ret:
  - ◇ normal: normal mode (100ms interval)
- ◆ mode:
  - ◇ normal: normal mode (100ms interval)
  - ◇ standby: WiFi shut down mode

#### 4.2.2.60. AT+NTPRF

- Function: Set /Query time calibration interval

- Format:

- ◆ Query Operation

```
AT+ NTPRF<CR>
```

```
+ok=<num><CR>< LF ><CR>< LF >
```

- ◆ Set Operation

```
AT+ NTPRF=<num><CR>
```

```
+ok<CR>< LF ><CR>< LF >
```

- Parameters:



- ◆ num: time calibration interval, range:0~720, default:30 minutes, 10 minutes for each step, set 0 means no time calibration automatically.

## 4.2.2.61. AT+NTPEN

- Function: Enable/Disable time calibration function.
- Format:
  - ◆ Query Operation  
**AT+ NTPEN<CR>**  
**+ok=<status><CR>< LF ><CR>< LF >**
  - ◆ Set Operation  
**AT+ NTPEN=<status><CR>**  
**+ok<CR>< LF ><CR>< LF >**
- Parameters:
  - ◆ status: status of time calibration
    - on: Enable time calibration
    - off: Disable time calibration

## 4.2.2.62. AT+NTPTM

- Function: Query network time
- Format:
  - ◆ Query Operation  
**AT+ NTPTM<CR>**  
**+ok=<time><CR>< LF ><CR>< LF >**
- Parameters:
  - ◆ time: network time, for example: 2013-10-9 16:10:42 Wed, if it shows Not Available means that the time calibration function is not enabled or the module doesn't connect to the internet.

## 4.2.2.63. AT+WRMID

- Function: Set module ID;
- Format:
  - ◆ Set Operation  
**AT+ WRMID=<wrmid> <CR>< LF ><CR>< LF >**
- Parameters:
  - ◆ wrmid: set module's ID (within 20 characters).

## 4.2.2.64. AT+RLDEN

- Function: Set/Query GPIO45 function status
- Format:
  - ◆ Query Operation  
**AT+RLDEN<CR>**  
**+ok=<status><CR>< LF ><CR>< LF >**
  - ◆ Set Operation  
**AT+RLDEN=<status><CR>**

```
+ok<CR>< LF ><CR>< LF >
```

- Parameters:
  - ◆ status: The status of module's GPIO45(nReload) function
    - ◇ on: GPIO45 function (nReload) is enabled.
    - ◇ off: GPIO45 function is disabled

#### 4.2.2.65. AT+ASWD

- Function: Set/Query WiFi Configuration Password;
- Format:
  - ◆ Query Operation

```
AT+ ASWD<CR>
```

```
+ok=<aswd> <CR>< LF ><CR>< LF >
```

- ◆ Set Operation

```
AT+ ASWD=<aswd> <CR>< LF ><CR>< LF >
```

- Parameters:
  - ◆ aswd: WiFi Configuration Password (within 20 characters).

#### 4.2.2.66. AT+MDCH

- Function: Set Wi-Fi Auto Switch Function
- Format:
  - ◆ Query Operation

```
AT+ MDCH<CR>
```

```
+ok=<mode> <CR>< LF ><CR>< LF >
```

- ◆ Set Operation

```
AT+ MDCH=<mode> <CR>< LF ><CR>< LF >
```

- Parameters:
  - ◆ mode: Wi-Fi Auto Switch Mode
    - ◇ off: Disable Wi-Fi auto switch.
    - ◇ on: Enable Wi-Fi auto switch. When the module(STA mode) fail to connect to router, it will switch to AP mode itself in one minute.
    - ◇ auto: Enable Wi-Fi auto detect function. The module will reset itself when encounter any abnormal. The default time interval is 10 minutes.
    - ◇ 3-120: unit: minute. Set the time interval to reset itself when abnormal.

#### 4.2.2.67. AT+TXPWR

- Function: Set/Query Wi-Fi Transmit Power, Real Transmit Power=Default Transmit Power(16dBm) - [Setting Value] \* 0.5dBm
- Format:
  - ◆ Query Operation

```
AT+TXPWR <CR>
```

```
+ok=<num><CR>< LF ><CR>< LF >
```

- ◆ Set Operation

```
AT+TXPWR=<num><CR>
```

```
+ok<CR>< LF ><CR>< LF >
```

- Parameters:
  - ◆ num: [Setting Value]. The default is 0, it can be sent from 0 ~ 24. If set to 24, the module transmit power will be at a minimum of 4dBm. Reboot to make this setting change valid. It will not restore to default if reload the module.

#### 4.2.2.68. AT+LPTIO

- Function: Enable/Disable module's nReady, nLink function
- Format:
  - ◆ Query Operation  
**AT+LPTIO<CR>**  
**+ok=<status><CR>< LF><CR>< LF>**
  - ◆ Set Operation  
**AT+LPTIO=<status><CR>**  
**+ok<CR>< LF><CR>< LF>**
- Parameters:
  - ◆ staus: Enable/Disable nReady, nLink function. PWM\_1 pin is for nLink function, PWM\_2 pin is for nReady function.
    - ◇ on: Enable nReady, nLink function
    - ◇ off: Disable nReady, nLink function

## 5. PACKAGE INFORMATION

### 5.1. Recommended Reflow Profile

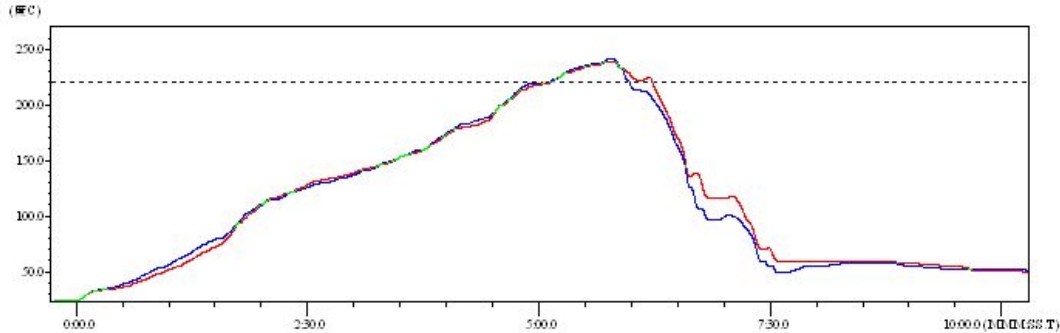

Figure 33. Reflow Soldering Profile

Table 11 Reflow Soldering Parameter

NO.	Item	Temperature (Degree)	Time (Sec)
1	Reflow Time	Time of above 220	35~55 sec
2	Peak-Temp	260 max	

- Note:**
1. Recommend to supply N2 for reflow oven.
  2. N2 atmosphere during reflow (O2<300ppm)

### 5.2. Device Handling Instruction (Module IC SMT Preparation)

1. Shelf life in sealed bag: 12 months, at <30°C and <60% relative humidity (RH)
2. After bag is opened, devices that will be re-baked required after last baked with window time 168 hours.
3. Recommend to oven bake with N2 supplied
4. Recommend end to reflow oven with N2 supplied
5. Baked required with 24 hours at 125+/-5°C before rework process for two modules, one is new module and two is board with module
6. Recommend to store at ≤10% RH with vacuum packing
7. If SMT process needs twice reflow:
  - (1) Top side SMT and reflow . (2) Bottom side SMT and reflow

Case 1: Wifi module mounted on top side. Need to bake when bottom side process over 168 hours window time, no need to bake within 168 hours

Case 2: Wifi module mounted on bottom side, follow normal bake rule before process

**Note:** Window time means from last bake end to next reflow start that has 168 hours space.

### 5.3. Shipping Information

#### TRAY

#### BOX

Size: 420\*245\*34 mm

Size: 422\*247\*72 mm (inside)

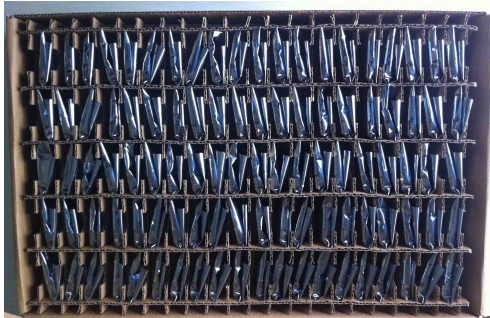

**Note:**

1 tray = 5\*20pcs = 100 pcs

1 box = 2 trays = 2 \* 100 pcs = 200pcs

# APPENDIX A: HW REFERENCE DESIGN

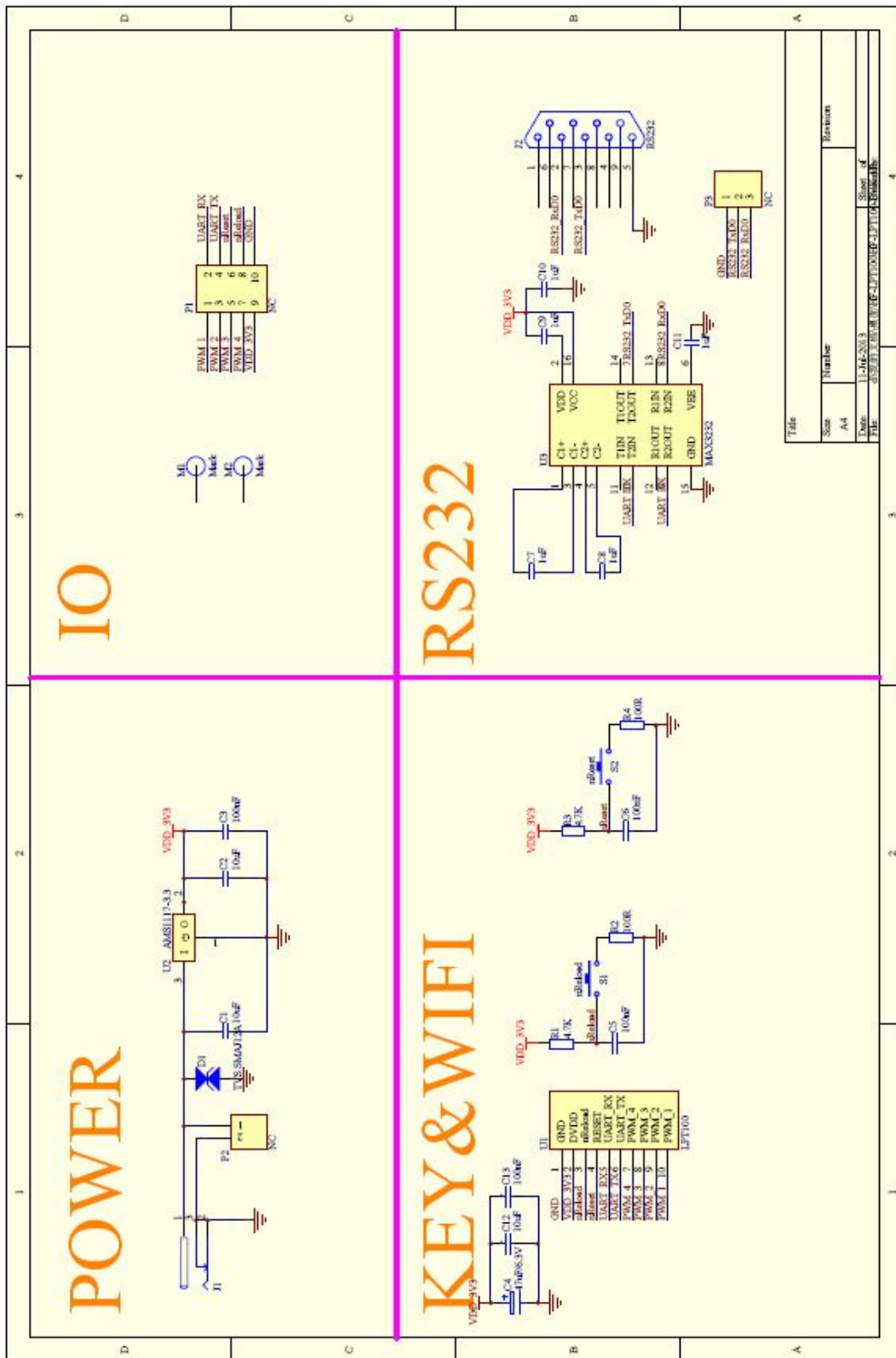

Detailed USR-WIFI232-T Evaluation Board design source files, pls access USR Technology web download page or contact with USR Technology technical support people to acquire.

# APPENDIX B: CONTROL GPIO/PWM FUNCTION WITH NETWORK COMMANDS

Send command data to control module's GPIO, PWM port after make network connection with TCP or UDP protocol. The status of GPIO won't be changed if the module is reset.

## B.1 Network Command

### B.1.1 GPIO <channel> OUT <value>

- Function: Set GPIO Channel value temporarily..
- Parameters:
  - ◆ channel:GPIO Channel number, it can be 11、12、18(GPIO Pin Number )
  - ◆ value:GPIO Channel value,1(high voltage), 0(low voltage)
- Return Data:
  - ◆ GPIO OK: Command successful
  - ◆ GPIO NOK: Command failed

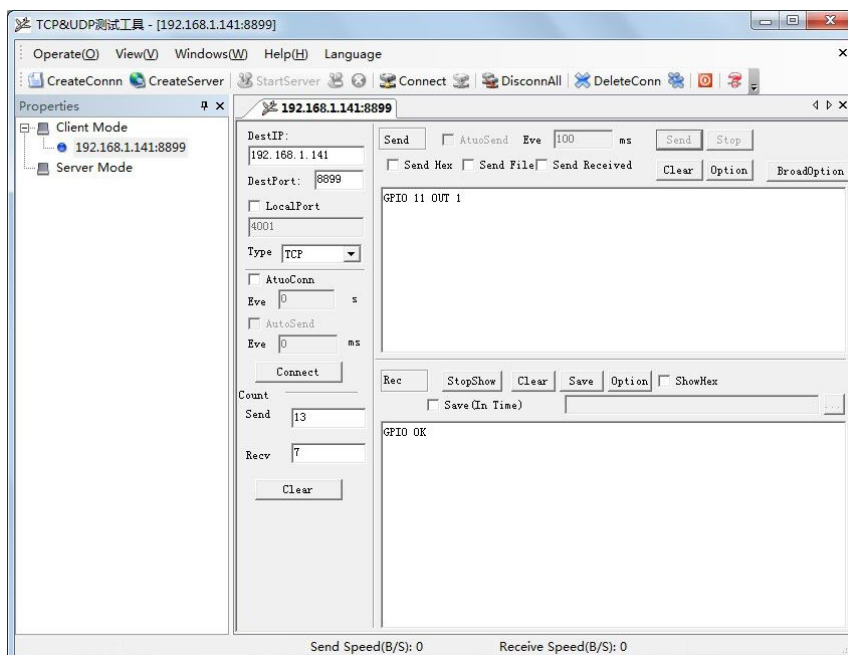

### B.1.2 GPIO <channel> GET

- Function: Query GPIO Channel value
- Parameters:
  - ◆ channel: GPIO Channel number,it can be 11、12、18(GPIO Pin Number )
- Return Data:



- ◆ +ok=<value>
  - value:GPIO Channel value
- ◆ GPIO NOK: Command failed

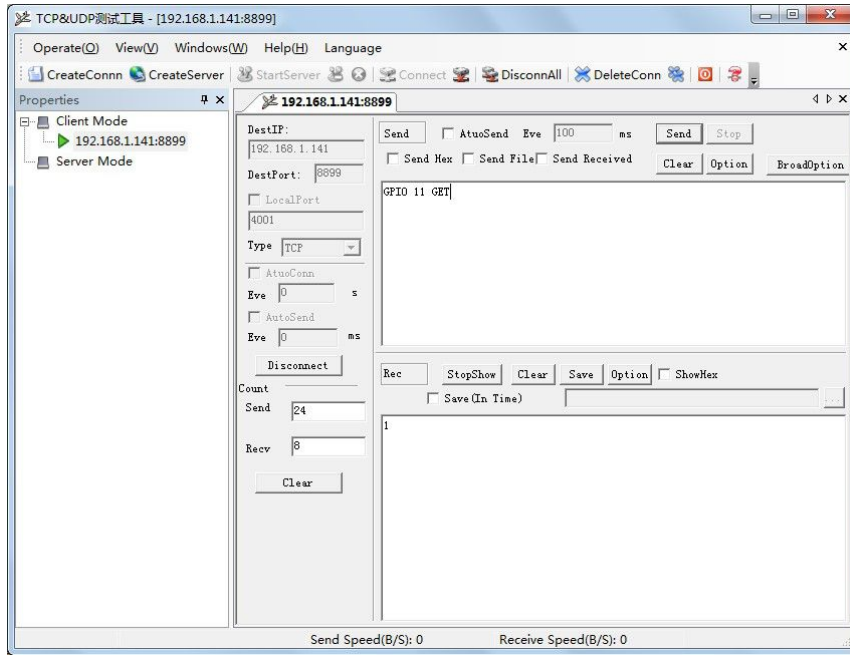

### B.1.3 GPIO <channel> SET

- Function: Save GPIO Channel setting
- Parameters:
  - ◆ channel:GPIO Channel number, it can be 11、12、18 (GPIO Pin Number )
- Return Data:
  - ◆ GPIO OK: Command successful
  - ◆ GPIO NOK: Command failed

### B.1.4 PWM <channel frequency duty>

- Function: Set PWM Channel output temporarily
- Parameters:
  - ◆ channel:PWM Channel number, it can be 11、12、18 (GPIO Pin Number )
  - ◆ frequency:PWM Channel frequency, it can be 500~60000
  - ◆ duty:PWM Channel duty, it can be 0~100.
- Return Data:
  - ◆ PWM OK: Command successful
  - ◆ PWM NOK: Command failed

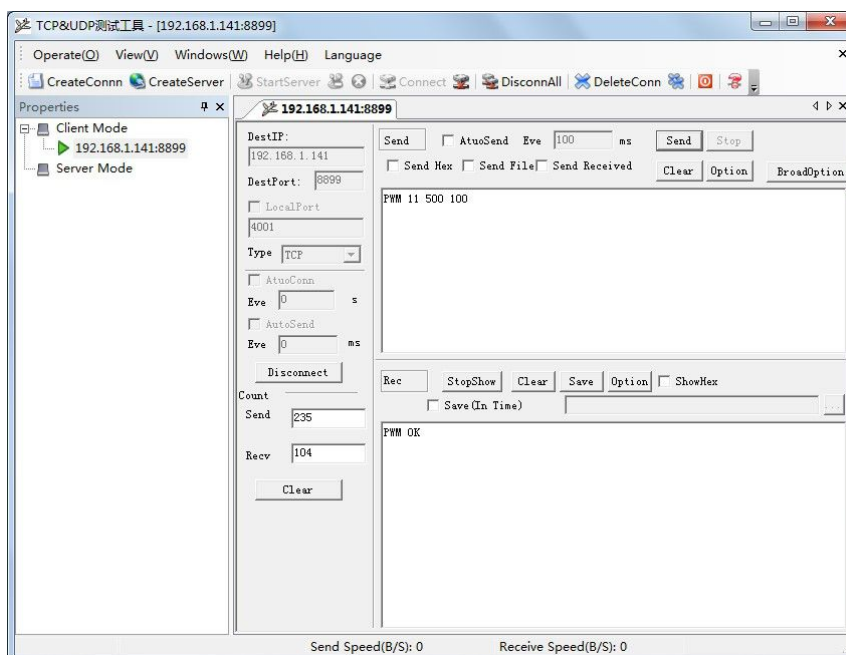

### B.1.5 PWM <channel> GET

- Function: Query PWM Channel output
- Parameters:
  - ◆ channel: PWM Channel number, it can be 11、12、18 (GPIO Pin Number )
- Return Data:
  - ◆ +ok=<frequency duty>
    - frequency: PWM Channel frequency
    - duty: PWM Channel duty
  - ◆ PWM NOK: Command failed

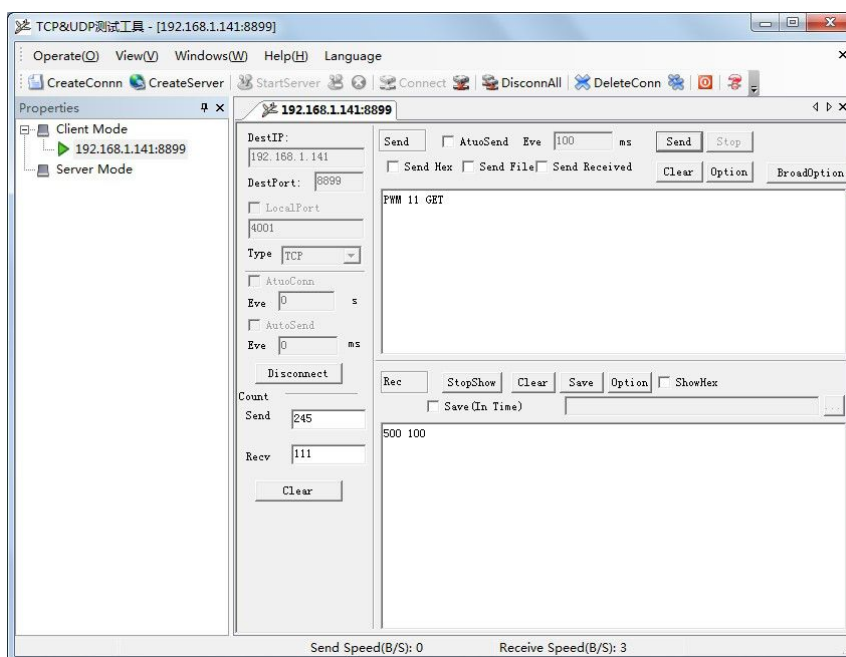

### B.1.6 PWM <channel> SET

- Function: Save PWM Channel setting
- Parameters:
  - ◆ channel: PWM Channel number, it can be 11、12、18、20 (GPIO Pin number)
- Return Data:
  - ◆ PWM OK: Command successful
  - ◆ PWM NOK: Command failed

## B.2 Hexadecimal Network Command

Send hexadecimal data to fastly read module's port status.

### B.2.1 Read All PWM Channel Frequency

- Send Data: **【30】** :
- Return Data: **【b0 <value1 value2 value3 value4 value5 value6 value7 value8>】**
  - ◆ value1: High byte of PWM Channel 0 (GPIO11) frequency
  - ◆ value2: Low byte of PWM Channel 0 (GPIO11) frequency
  - ◆ value3: High byte of PWM Channel 1 (GPIO12) frequency
  - ◆ value4: Low byte of PWM Channel 1 (GPIO12) frequency
  - ◆ value5: High byte of PWM Channel 2 (GPIO18) frequency
  - ◆ value6: Low byte of PWM Channel 2 (GPIO18) frequency
  - ◆ value7: Not used
  - ◆ value8: Not used

### B.2.2 Write PWM Channel Frequency

- Send Data: **【32 <channel value1 value2>】** :
  - ◆ channel: PWM Channel number
  - ◆ value1: High byte of PWM Channel frequency
  - ◆ value2: Low byte of PWM Channel frequency
- Return Data: **【b2 <channel value1 value2>】**
  - ◆ Channel: PWM Channel number
  - ◆ value1: High byte of PWM Channel frequency
  - ◆ value2: Low byte of PWM Channel frequency

### B.2.3 Read All PWM Channel Duty

- Send Data: **【20】** :
- Return Data: **【a0 <value1 value2 value3 value4>】**
  - ◆ value1: Duty of PWM Channel 0
  - ◆ value2: Duty of PWM Channel 1
  - ◆ value3: Duty of PWM Channel 2
  - ◆ value4: Not used.

### B.2.4 Write PWM Channel Duty

- Send Data: **【22 <channel value1>】** :
  - ◆ channel: PWM Channel number
  - ◆ value1: Duty of PWM Channel
- Return Data: **【a2 <channel value1>】**
  - ◆ Channel: PWM Channel number
  - ◆ value1: Duty of PWM Channel

#### B.2.5 Save Present GPIO, PWM Setting

- Send Data: **【7a】** :
- Return Data: **【fa】**

#### B.2.6 Read Resources of module

- Send Data: **【7e】** :
- Return Data: **【fe <value1 value2 value3>】**
  - ◆ value1: Module's GPIO output pin number .
  - ◆ value2: Module's GPIO input pin number
  - ◆ value3: Module's PWM pin number

## APPENDIX C: HTTP PROTOCOL TRANSFER

USR-WIFI232-T module support http data transfer in command mode. If any detailed HTTP protocol, contact us and we may support customization.

### C.1. HTTP AT command

#### C.1.1. AT+ HTTPURL

- Function: Set /Query HTTP server IP address and Port Number.
- Format:
  - ◆ Query Operation  
`AT+HTTPURL<CR>`  
`+ok=<IP,Port><CR>< LF ><CR>< LF >`
  - ◆ Set Operation  
`AT+HTTPURL=<IP,Port><CR>`  
`+ok<CR>< LF ><CR>< LF >`
- Parameters:
  - ◆ IP: IP address.
  - ◆ Port: Port number.

#### C.1.2. AT+ HTTPTP

- Function: Set /Query HTTP request type
- Format:
  - ◆ Query Operation  
`AT+HTTPTP<CR>`  
`+ok=<Type><CR>< LF ><CR>< LF >`
  - ◆ Set Operation  
`AT+HTTPTP=<Type><CR>`  
`+ok<CR>< LF ><CR>< LF >`
- Parameters:
  - ◆ Type: GET(default) or POST.

#### C.1.3. AT+ HTTPPH

- Function: Set/Query HTTP protocol header path.
- Format:
  - ◆ Query Operation  
`AT+HTTPPH<CR>`  
`+ok=<Path><CR>< LF ><CR>< LF >`
  - ◆ Set Operation  
`AT+HTTPPH=<Path><CR>`  
`+ok<CR>< LF ><CR>< LF >`

- Parameters:
  - ◆ Path: Max length is 50 bytes.

#### C.1.4. AT+ HTTPCN

- Function: Set/Query Connection of HTTP protocol header
- Format:
  - ◆ Query Operation  
**AT+HTTPCN<CR>**  
**+ok=<Connection><CR>< LF ><CR>< LF >**
  - ◆ Set Operation  
**AT+HTTPCN=<Connection><CR>**  
**+ok<CR>< LF ><CR>< LF >**
- Parameters:
  - ◆ Connection: Max length is 20 bytes.

#### C.1.5. AT+ HTTPUA

- Function: Set/Query User-Agent of HTTP protocol header.
- Format:
  - ◆ Query Operation  
**AT+HTTPUA<CR>**  
**+ok=<Parameter><CR>< LF ><CR>< LF >**
  - ◆ Set Operation  
**AT+HTTPUA=<Parameter><CR>**  
**+ok<CR>< LF ><CR>< LF >**
- Parameters:
  - ◆ Parameter: Max length is 20 bytes.

#### C.1.6. AT+ HTTPDPT

- Function: Send HTTP request or data.
- Format:
  - ◆ Set Operation  
**AT+HTTPDPT=<Data><CR>**  
**+ok<CR>< LF ><CR>< LF >**
- Parameters:
  - ◆ Data: HTTP request data, send AT+HTTPDPT directly if no data to be sent.

## C.2. HTTP Example

HTTP parameter settings are as follows:

AT+HTTPURL=192.168.1.1,80	Set HTTP server address and port
AT+HTTPPTP=POST	Set HTTP request type
AT+HTTPPPH=/abcd	Set HTTP protocol header path
AT+HTTPCN= keep-alive	Set HTTP Connection area

AT+HTTTPUA= lwip1.3.2                      Set HTTP User-Agent area

If send "AT+HTTTPDT", the data packet will be sent as the following instance including the two new line:

```
POST /abcd HTTP/1.1
Connection:keep-alive
User-Agent:lwip1.3.2
Content-Length:0
Host:192.168.0.127:8999
```

If send AT+HTTTPDT=abcd, the data packet will be sent as the following instance:

```
POST /abcd HTTP/1.1
Connection:keep-alive
User-Agent:lwip1.3.2
Content-Length:4
Host:192.168.0.127:8999
```

abcd

The data received from HTTP server will be output to serial port and end with "+ok".

If the module hasn't received data from HTTP server for 5 second, it will cut the TCP link with HTTP server.

## APPENDIX D: CONTACT INFORMATION

---

Jinan USR IOT Technology Limited

Address: 1-728, Huizhan Guoji Cheng, Gaoxin Qu, Jinan, Shandong, China

Tel: 86-531-55507297 86-531-88826739-803

Web: <http://en.usr.cn> Skype: lisausr

Email: [sales@usr.cn](mailto:sales@usr.cn) [tec@usr.cn](mailto:tec@usr.cn)

---

**END OF DOCUMENT**