

# USR-WIFI232-S/T/G2/H

## Low Power WiFi Module User Manual V2.1

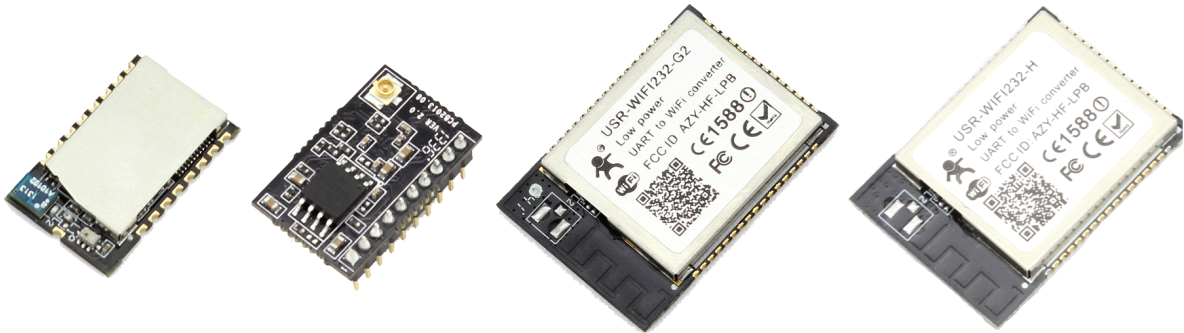

USR-WIFI232-S

USR-WIFI232-T

USR-WIFI232-G2

USR-WIFI232-H

### Overview of Characteristic

- Support IEEE802.11b/g/n Wireless Standards
- Based on Self-developed High Performance MCU
- Ultra-Low-Power for Battery Applications with Excellent Power Save Scheme
- Support UART/PWM/GPIO Data Communication Interface
- Support Work As STA/AP/AP+STA Mode
- Support Smart Link Function (APP program provide)
- Support Network Configuration by Audio.(USR-WIFI232-H)
- Support Wireless Upgrade Function
- Support WPS Function
- Support Multi-TCP Link (5 Channel) Application
- Support Internal/External(I-PEX/SMA) Antenna Option
- Single +3.3V Power Supply
- Smallest Size:
 

USR-WIFI232-S	22mm x 13.5mm x 2.3mm,	SMT Footprint
USR-WIFI232-T	22mm x 13.5mm x 6mm,	1x10 2mm Connector
USR-WIFI232-G2	23.1mm x 32.8mm x 2.7mm,	SMT Footprint
USR-WIFI232-H	23.1mm x 32.8mm x 2.7mm,	SMT Footprint
- FCC/CE Certificated

# Catalogue

<b>1、 Quick start</b> .....	6
<b>1.1 Hardware connect</b> .....	6
<b>1.2 Network connection</b> .....	6
<b>1.3 communication test</b> .....	7
<b>1.4 Application Examples</b> .....	8
<b>1.4.1 Wireless remote control applications</b> .....	8
<b>1.4.2 Remote connectivity applications</b> .....	9
<b>1.4.3 Transparent Transmission</b> .....	9
<b>2、 Product Overview</b> .....	11
<b>2.1 General Description</b> .....	11
<b>2.2 Device Features</b> .....	11
<b>2.3 Device Parameters</b> .....	12
<b>2.4 Modules feature comparison</b> .....	13
<b>2.5 Key Application</b> .....	13
<b>2.6 Package Information</b> .....	14
<b>3、 Hardware Introduction</b> .....	16
<b>3.1 Pins Definition</b> .....	16
<b>3.1.1. USR-WIFI232-S Pins Definition</b> .....	16
<b>3.1.2. USR-WIFI232-T Pins Definition</b> .....	18
<b>3.1.3. USR-WIFI232-G2 Pins Definition</b> .....	20
<b>3.1.4. USR-WIFI232-H Pins Definition</b> .....	23
<b>3.2 Electrical Characteristics</b> .....	26
<b>3.3 Mechanical Size</b> .....	26
<b>3.3.1 USR-WIFI232-S</b> .....	26
<b>3.3.2 USR-WIFI232-T</b> .....	27
<b>3.3.3 USR-WIFI232-G2/H</b> .....	28
<b>3.4 Antenna</b> .....	29
<b>3.4.1 USR-WIFI232-S</b> .....	29
<b>3.4.2 USR-WIFI232-T</b> .....	30
<b>3.4.3 USR-WIFI232-G2/H</b> .....	31
<b>3.5 Evaluation Kit</b> .....	32
<b>3.6 Typical Application Hardware</b> .....	33
<b>3.6.1 UART Application Hardware</b> .....	33
<b>3.6.2 PWM/GPIO Application Hardware</b> .....	33
<b>4、 Modules function description</b> .....	34
<b>4.1 Work Mode</b> .....	34
<b>4.1.1 Throughput mode</b> .....	34
<b>1.Throughput mode brief introduction</b> .....	34
<b>2.UART Frame Scheme</b> .....	35
<b>4.1.2 Command Mode</b> .....	36
<b>4.1.3 GPIO/PWM Mode</b> .....	36
<b>4.2 Wireless Networking</b> .....	37

4.2.1 STA WI-FI Mode	38
4.2.2 AP WI-FI Mode	38
4.2.3 AP+STA WI-FI Mode	38
4.2.4 Encryption	39
4.3 Socket Communication	39
4.3.1 Socket A	40
4.3.2 Socket B	40
4.4 Network configuration by audio	40
4.4.1. Introduction	40
4.4.2. Peripheral circuit	41
4.5 Parameter configuration	41
4.6 Firmware and web upgrade	41
5、 Module Parameter configuration	43
5.1 Web	43
5.1.1 Web Brief Description	43
5.1.2 Open Web Management Interface	43
5.1.3 System Page	44
5.1.4 Work Mode Page	44
5.1.5 STA Setting Page	45
5.1.6 AP Setting Page	45
5.1.7 Other Setting Page	46
5.1.8 Account Management Page	46
5.1.9 Upgrade Software Page	47
5.1.10 Restart Page	47
5.1.11 Restore Page	48
5.2 AT command	48
5.2.1 Switch to Command Mode	49
5.2.2 AT command Overview	50
5.2.3 AT command introduction	51
1) AT+E	53
2) AT+WMODE	53
3) AT+ENTM	54
4) AT+TMODE	54
5) AT+MID	54
6) AT+RELD	54
7) AT+Z	54
8) AT+H	54
9) AT+CFGTF	55
10) AT+UART	55
11) AT+UARTF	55
12) AT+UARTFT	56
13) AT+UARTFL	56
14) AT+UARTTE	56
15) AT+PING	56

<b>16)</b>	<b>AT+SEND</b>	57
<b>17)</b>	<b>AT+RECV</b>	57
<b>18)</b>	<b>AT+NETP</b>	57
<b>19)</b>	<b>AT+MAXSK</b>	58
<b>20)</b>	<b>AT+TCPLK</b>	58
<b>21)</b>	<b>AT+TCPTO</b>	58
<b>22)</b>	<b>AT+TCPDIS</b>	59
<b>23)</b>	<b>AT+SOCKB</b>	59
<b>24)</b>	<b>AT+TCPDISB</b>	59
<b>25)</b>	<b>AT+TCPTOB</b>	60
<b>26)</b>	<b>AT+TCPLKB</b>	60
<b>27)</b>	<b>AT+SNDB</b>	60
<b>28)</b>	<b>AT+RCVB</b>	61
<b>29)</b>	<b>AT+WSSSID</b>	61
<b>30)</b>	<b>AT+WSKEY</b>	61
<b>31)</b>	<b>AT+WANN</b>	62
<b>32)</b>	<b>AT+WSMAC</b>	62
<b>33)</b>	<b>AT+WSLK</b>	62
<b>34)</b>	<b>AT+WSLQ</b>	62
<b>35)</b>	<b>AT+WSCAN</b>	63
<b>36)</b>	<b>AT+WSDNS</b>	63
<b>37)</b>	<b>AT+LANN</b>	63
<b>38)</b>	<b>AT+WAP</b>	63
<b>39)</b>	<b>AT+WAKEY</b>	64
<b>40)</b>	<b>AT+WAMAC</b>	64
<b>41)</b>	<b>AT+WADHCP</b>	64
<b>42)</b>	<b>AT+WALK</b>	65
<b>43)</b>	<b>AT+WALKIND</b>	65
<b>44)</b>	<b>AT+PLANG</b>	65
<b>45)</b>	<b>AT+WEBU</b>	65
<b>46)</b>	<b>AT+MSLP(Reserved)</b>	66
<b>47)</b>	<b>AT+NTPRF</b>	66
<b>48)</b>	<b>AT+NTPEN</b>	66
<b>49)</b>	<b>AT+NTPTM</b>	67
<b>50)</b>	<b>AT+WRMID</b>	67
<b>51)</b>	<b>AT+ASWD</b>	67
<b>52)</b>	<b>AT+MDCH</b>	67
<b>53)</b>	<b>AT+TXPWR</b>	68
<b>54)</b>	<b>AT+WPS</b>	68
<b>55)</b>	<b>AT+WPSBTNEN</b>	68
<b>56)</b>	<b>AT+SMTLK</b>	68
<b>57)</b>	<b>AT+LPTIO</b>	69
<b>Appendix A: HW Reference Design</b>		<b>70</b>
<b>    USR-WIFI232-S Evaluation Kit Schematic</b>		<b>70</b>

<b>USR-WIFI232-T Evaluation Kit Schematic</b> .....	71
<b>USR-WIFI232-G2 Evaluation Kit Schematic</b> .....	72
<b>USR-WIFI232-H Evaluation Kit Schematic</b> .....	73
<b>Appendix B: GPIO/PWM CONTROL WITH NETWORK COMMANDS</b> .....	74
<b>Appendix C: HTTP PROTOCOL TRANSFER</b> .....	79
<b>Appendix D: Contact Information</b> .....	82
<b>Appendix E: Disclaimer</b> .....	82
<b>Appendix F: Update History</b> .....	82

## 1、Quick start

USR-WIFI232 series product is used to transmit data between RS232 and WIFI TCPIP transparently, user can update the product to WIFI control without knowing the WIFI and TCPIP detail. All the convert work is done by the module. For users, the RS232 side is only as a serial device, the WIFI side is TCPIP Socket data. User can setup the work detail by sample settings which can setup via inside web pages or RS232 port. The setup work only need do once, then it will save the setting forever.

This chapter is a user guide for USR-WIFI232 series products. We suggest users follow the guide to test module at first, and will have a good understanding of the modules. Users can also choose the chapter which you are interested in to read. For specific details and instructions, please refer to the following chapters.

### 1.1 Hardware connect

In order to test WIFI module, we need connect module RS232 to PC and also WIFI to PC.

In order to test the communication between serial and WIFI network, we need to connect the serial port to PC, and also connect WIFI networks to PC. Due to the special need both WIFI and serial, we use PC which add USB WIFI network Card such as the following picture.

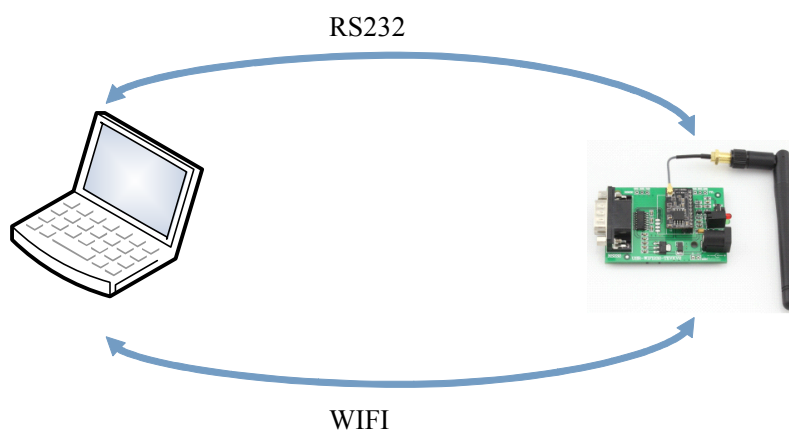

Figure 1 hardware connection diagram

About the serial connection, because the module RS232 is 3.3V TTL level, the computer can not connect to module directly, the user needs to have a TTL to RS232 adapter cable and then connect to the computer. in order to facilitate the test, we provide USR-WIFI232-S/T/G2/H evaluation board for users to choose.

### 1.2 Network connection

The following is the USR-WIFI232-T module example, except SSID, other modules

are the same to USR-WIFI232-T. Open Wi-Fi, search network, as shown in below, USR-WIFI232-T is the default network name (SSID) of the module.



Figure 2 WIFI Search

Join the network, choose to automatically obtain IP, WIFI module supports DHCP Server feature and is enabled by default.

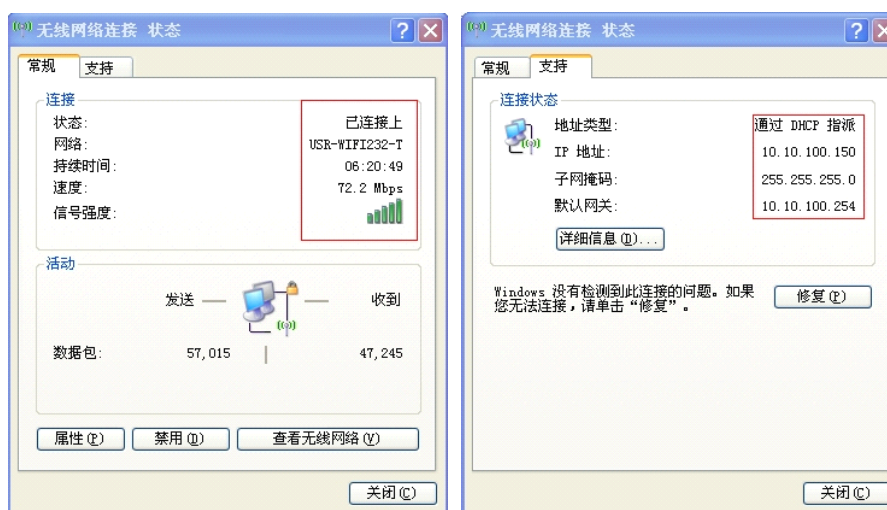

Figure 3 WIFI connection

Now, nlink led of USR-WIFI232-T Evaluation Board is lighting.

### 1.3 communication test

Module's default setting:

- **SSID:** USR-WIFI232-T;
- **Encryption mode:** open,none;
- **UART:** 115200,8,1,None;
- **Network parameters:** TCP,Server,8899,10.10.100.254;
- **IP:** DHCP,0.0.0.0,0.0.0.0,0.0.0.0

We just need to follow the parameters of the corresponding set of network communication parameters, you can make serial <--> WIFI communication, the steps are as follows:

1. Open test software USR-TCP232-Test;
2. COM Settings area (left):  
Choose COM port witch has connect the module, there is COM3, choose band rate to 115200, this is the default band rate of WIFI module, Click Open COM port.
3. Net Settings area (right):  
Choose TCP client mode, Server IP write 10.10.100.254, it is the WIFI default IP address, Server port to 8899, It is the default Port the WIFI module listen, Click Connect to link to the module.

Now, you can test send data between RS232 and WIFI.

**COM port to WIFI:** PC RS232 -> Module RS232 -> Module WIFI -> PC WIFI,  
**WIFI to COM port:** PC WIFI -> Module WIFI -> Module RS232 -> PC RS232.

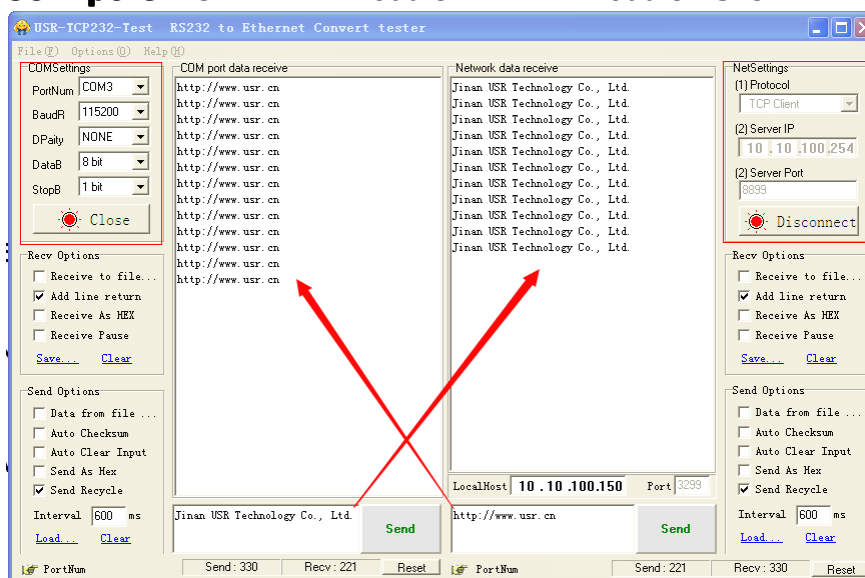

Figure 4 serial / network parameter settings and transmission test

## 1.4 Application Examples

### 1.4.1 Wireless remote control applications

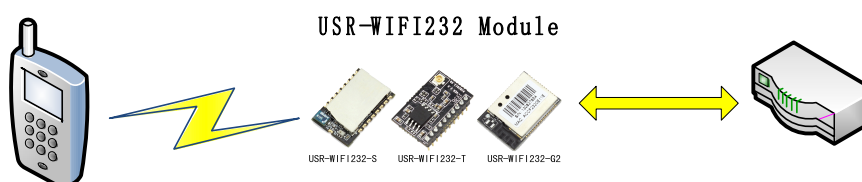

Figure 5 Wireless remote control applications

In the wireless remote control applications, USR-WIFI232 module works in AP



mode. USR-WIFI232 module's serial connect user's devices. Control client (such as smartphones) can controll the user equipment via wireless network.

## 1.4.2 Remote connectivity applications

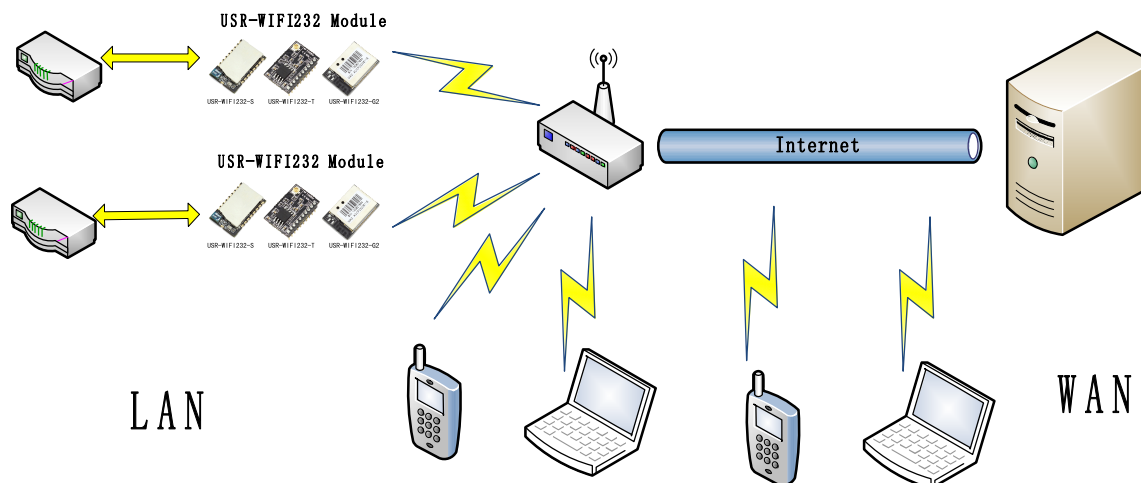

Figure 6 Remote connectivity applications

In remote connection applications, USR-WIFI232 module works in the STA mode, connect to internet through internet gateway. Module is set to TCP Client, connected to the internet TCP server. User devices connected to USR-WIFI232 module through the serial port.

This application can collect data from the user device and send it to the server for processing and storage, the internet server can also send commands to control the user device for control. Users can use smartphone or PC to control the user device via LAN, and also can control the user device via WAN by communicate to internet server.

## 1.4.3 Transparent Transmission

In this application, two USR-WIFI232 modules connect by Wi-Fi as shown below, this application is to build a transparent serial channel between two user devices.

The following figure is set as follows:

- Left of the USR-WIFI232 module is set to AP mode, SSID and IP address are default, network protocol is set to TCP / Server mode, protocol port is 8899 by defaults.
- Right of the USR-WIFI232 module is set to STA mode, SSID is set to the AP's SSID which will be connected to (eg USR-WIFI232-T), the IP address is DHCP by default, network protocol is set to TCP / Client mode, protocol port 8899, Target IP address is set to the left of the module, i.e. 10.10.100.254.

When the right side module startup will find AP (SSID: USR-WIFI232-T), and then automatically connect to the left side TCP server as client. All connections can complet automatically, both sides of the UART can transparently transmit data.

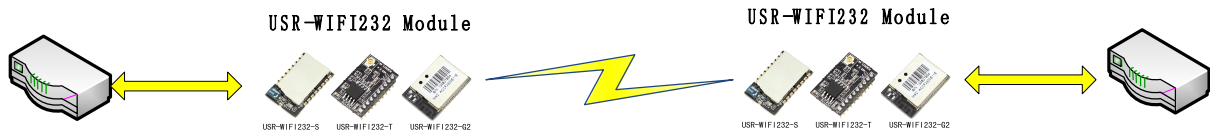

Figure 7 Transparent serial

## 2、 Product Overview

### 2.1 General Description

USR-WIFI232-S/T/G2/H is a fully self-contained small form-factor, single stream, 802.11b/g/n Wi-Fi module, which provide a wireless interface to any equipment with a Serial interface for data transfer.

USR-WIFI232-S/T/G2/H integrate MAC, baseband processor, RF transceiver with power amplifier in hardware and all Wi-Fi protocol and configuration functionality and networking stack, in embedded firmware to make a fully self-contained 802.11b/g/n Wi-Fi solution for a variety of applications.

USR-WIFI232-S/T/G2/H adopts the world's lowest power consumption embedded architecture. It has been optimized for all kinds of client applications in the home automation, smart grid, handheld device, personal medical application and industrial control that have lower data rates, and transmit or receive basis data at low rate.

USR-WIFI232-S/T/G2/H integrates all Wi-Fi functionality into a low-profile, small module package that can be easily mounted on main PCB with application specific circuits. Also, module provides built-in antenna, external antenna option. The following is the size of module.

USR-WIFI232-S	22mm x 13.5mm x 2.3mm,	SMT Footprint
USR-WIFI232-T	22mm x 13.5mm x 6mm,	1x10 2mm Connector
USR-WIFI232-G2	23.1mm x 32.8mm x 2.7mm,	SMT Footprint
USR-WIFI232-H	23.1mm x 32.8mm x 2.7mm,	SMT Footprint

### 2.2 Device Features

- Support IEEE802.11b/g/n Wireless Standards
- Support WIFI@2.4 GHz, support WEP, WPA/WPA2 security mode.
- Based on Self-developed High Performance MCU
- Ultra-Low-Power for Battery Applications with Excellent Power Save Scheme
- Support UART/PWM/GPIO Data Communication Interface
- Support Work As STA/AP/AP+STA Mode
- Support SmartLink Function (APP program provide)
- Support Network Configuration by Audio.(USR-WIFI232-H)
- Support Wireless Upgrade Function
- Support WPS Function
- Support Multi-TCP Link (5 Channel) Application
- Support Internal/External(I-PEX/SMA) Antenna Option
- Single +3.3V Power Supply
- Smallest Size
- FCC/CE Certificated

## 2.3 Device Parameters

Table 1 USR-WIFI232-S/T/G2 Module Technical Specifications

Class	Item	Parameters
<b>Wireless Parameters</b>	Certification	FCC/CE
	Wireless standard	802.11 b/g/n
	Frequency range	2.412GHz-2.484GHz
	Transmit Power	802.11b: +16 +/-2dBm (@11Mbps)
		802.11g: +14 +/-2dBm (@54Mbps)
		802.11n: +13 +/-2dBm (@HT20, MCS7)
	Receiver Sensitivity	802.11b: -93 dBm (@11Mbps ,CCK)
802.11g: -85 dBm (@54Mbps, OFDM)		
802.11n: -82 dBm (@HT20, MCS7)		
Antenna Option	External: I-PEX connector (WIFI232-T/G2/H) SMA connector (WIFI232-S) Internal: On-board PCB antenna (WIFI232-S/G2/H)	
<b>Hardware Parameters</b>	Data Interface	UART
		PWM/GPIO(Except WIFI232-H)
		SPI( <b>Reserved</b> )
	Operating Voltage	3.0~3.6V
	Operating Current	Peak [Continuous TX]: ~200mA Average. ~12mA, Peak: 200mA Standby [WiFi Shutdown]: <200uA( <b>Reserved</b> )
	Operating Temp.	-40°C - 85°C
	Storage Temp.	-45°C - 125°C
	Dimensions and Size	22mm x 13.5mm x 2.3mm (WIFI232-S) 22mm x 13.5mm x 6mm (WIFI232-T) 23.1mm x 32.8mm x 2.7mm (WIFI232-G2/H)
Footprint	1x10, 2mm connector (WIFI232-T)	
	SMT (WIFI232-S/G2/H)	
<b>Software Parameters</b>	Network Type	STA/AP/STA+AP
	Security Mechanisms	WEP/WPA-PSK/WPA2-PSK
	Encryption	WEP64/WEP128/TKIP/AES
	Update Firmware	Local Wireless
	Customization	Web Page Upgrade
	Network Protocol	IPv4, TCP/UDP/HTTP
	User Configuration	AT+command Website (except WIFI232-S)

	Android/iOS APP, Smart Link APP tools
--	--

## 2.4 Modules feature comparison

Listed below are the basic functions of USR-WIFI232 low-power series:

Table 2 USR-WIFI232-S/T/G2Modules feature comparison

Feature		USR-WIFI232-S		USR-WIFI232-T	USR-WIFI232-G2		USR-WIFI232-H	
		-Sa	-Sb		-G2a	-G2b	-Ha	-Hb
WIFI	AP	√	√	√	√	√	√	√
	STA	√	√	√	√	√	√	√
	AP+STA	√	√	√	√	√	√	√
Socket	SocketA	√	√	√	√	√	√	√
	SocketB	√	√	√	√	√	√	√
UART-WIFI Transparent transmission		√	√	√	√	√	√	√
Embedded Web		No	No	√	√	√	√	√
AT+command		√	√	√	√	√	√	√
UART hardware flow control		√	√	No	√	√	√	√
Smartlink		√	√	√	√	√	No	No
Audio Network Configuration		No	No	No	No	No	√	√
WPS		√	√	√	√	√	√	√
PWM		No	No	3	4	4	No	No
GPIO		1	1	3	6	6	No	No
Antenna Option		On-board PCB antenna	SMA connector	I-PEX connector	On-board PCB antenna	I-PEX connector	On-board PCB antenna	I-PEX connector

**Note:**

WIFI232-T/G2's PWM/GPIO pin is multiplexed pin.

## 2.5 Key Application

- Remote equipment monitoring
- Industrial sensors and controls
- Asset tracking and telemetry
- Home automation
- Medical devices

## 2.6 Package Information

### 2.6.1 Recommended Reflow Profile

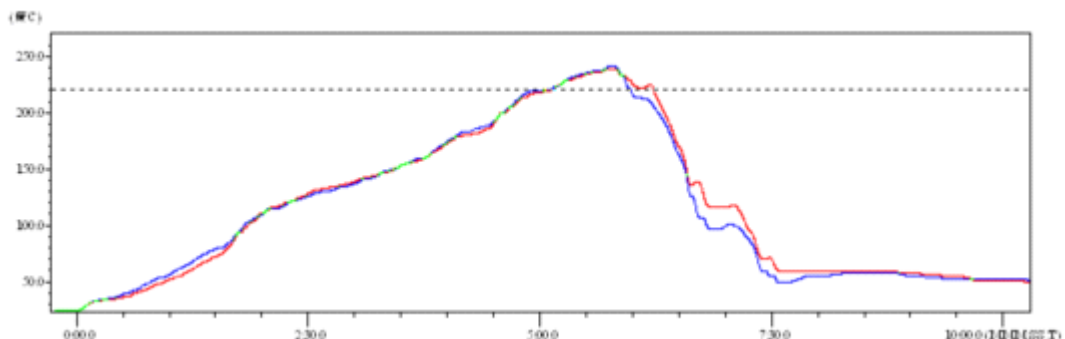

Figure 8 Reflow Soldering Profile

Table 3 Reflow Soldering Parameter

NO.	Item	Temperature (Degree)	Time(Sec)
1	Reflow Time	Time of above 220°C	35~55 sec
2	Peak-Temp	260°C max	

**Note:**

1. Recommend to supply N2 for reflow oven.
2. N2 atmosphere during reflow (O2<300ppm).

### 2.6.2 Device Handling Instruction (Module IC SMT Preparation)

- Shelf life in sealed bag: 12 months, at <30°C and <60% relative humidity (RH)
- After bag is opened, devices that will be re-baked required after last baked with window time 168 hours.
- Recommend to oven bake with N2 supplied.
- Baked required with 24 hours at 125±5°C before rework process for two modules, one is new module and two is board with module.
- Recommend to store at ≦10% RH with vacuum packing.
- If SMT process needs twice reflow:
  - (1) Top side SMT and reflow
  - (2) Bottom side SMT and reflow

Case 1: Wifi module mounted on top side. Need to bake when bottom side process over 168 hours window time, no need to bake within 168 hours.

Case 2: Wifi module mounted on bottom side, follow normal bake rule before process.

**Note:**

Window time means from last bake end to next reflow start that has 168 hours space.

## 2.6.3 Shipping Information

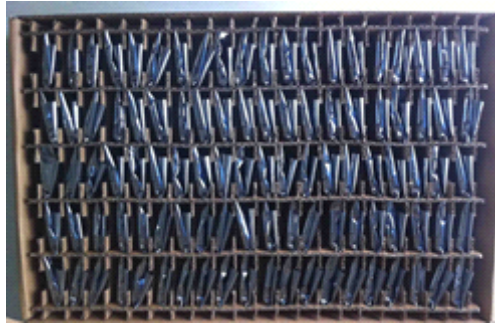

Figure 9 Shipping Information

**TRAY** Size: 420\*245\*34 mm

**Note:**

1 tray = 5\*20 pcs = 100 pcs

1 box = 2 trays = 2\*100 pcs = 200pcs

1 carton = 4 boxes = 4\*200 pcs = 800pcs

## 3、Hardware Introduction

### 3.1 Pins Definition

#### 3.1.1. USR-WIFI232-S Pins Definition

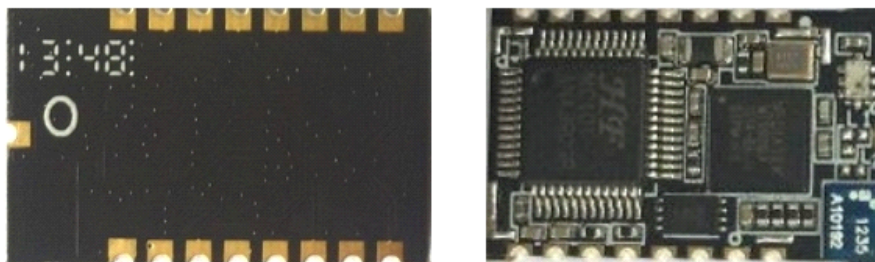

Figure 10 USR-WIFI232-S View

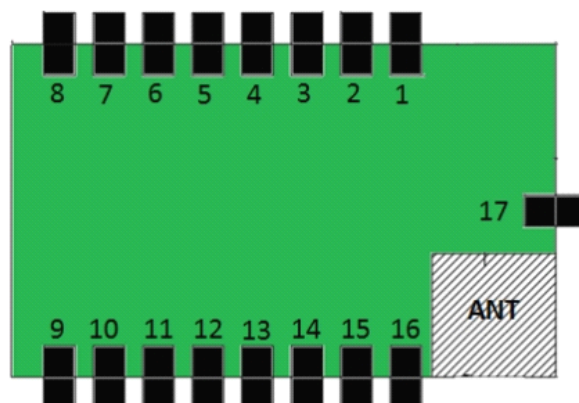

Figure 11 USR-WIFI232-S Pins Map

Table 4 USR-WIFI232-S Pins Definition

Pin	Description	Net Name	Signal Type	Comments
1	SPI Data Out	SPI_MOSI	O	SPI Interface ( <b>Reserved</b> )
2	SPI Clock	SPI_CLK	I/O	
3	SPI Data Out	SPI_MISO	I	
4	SPI CS	SPI_CS	I/O	
5	UART0	UART0_TX	O	UART Interface
6	UART0	UART0_RX	I	
7	UART0	UART0_CTS	I/O	
8	UART0	UART0_RTS	I/O	
9	GPIO	GPIO	I/O	GPIO23, No connect if not use
10	Module Reset	nReset	I	Low effective reset input. Pull-up if not use.
11	Module Boot Up	nReady	O	0 – Boot-up OK;



	Indicator			1 – Boot-up No OK; No connect if not use.
12	Module Recovery	nReload	I	Low effective reset input. Pull-up if not use. Can be set to Smart Link Pin
13	Wi-Fi Status	nLink	O	0- Wi-Fi Link. 1- No WIFI Link. No connect if not use.
14	WPS	WPS	I	WPS Function Pin. Pull-up if not use.
15	+3.3V Power	DVDD	Power	
16	Ground	GND	Power	
17	2.4GHz antenna PAD	ANT_2.4G	O	Must be 50ohm impedance

**< Explanation >:**

I—IN; O—OUT; PU—PULL-UP; I/O—IN/OUT GPIO;

**< The main pin function description >**

**nReset:**

Module reset pin, input GPIO, low effective.

Module nReset need pull-up when module works. If MCU module needs to do a reset operation, pull low for at least 10ms and then pull up.

**nReload:**

Module recover factory settings pin, input GPIO, low effective.

- 1) After module is powered up, short press this button (Low < 3s) to make the module go into "Smart Link" config mode, waiting for APP to set password and other information.
- 2) After module is powered up, long press this button (Low > 3s) to make the module recover to factory setting.

**nLink:**

Wi-Fi link status indicator pin, output GPIO, low effective. USR strongly suggest customer connect out this pin to LED.

- 1) At "Smart Link" config mode, this LED used to indicate APP to finish setting.
- 2) At normal mode, it's Wi-Fi link status indicator

**nReady:**

Module startup success indicator pin, output GPIO, low effective. Can be connected out to led.

**WPS:**

WPS function start pin, input GPIO, low effective. Can be connected to key.

**UART0\_TX/RX/CTS/RTS:**

UART pin

**GPIO n:**

GPIO which can be controlled by network cammands, n is control index number.

### 3.1.2. USR-WIFI232-T Pins Definition

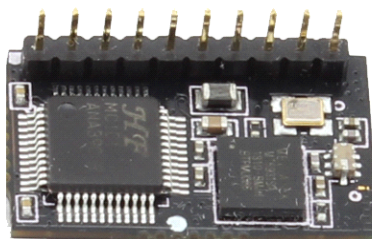

Figure 12 USR-WIFI232-T view

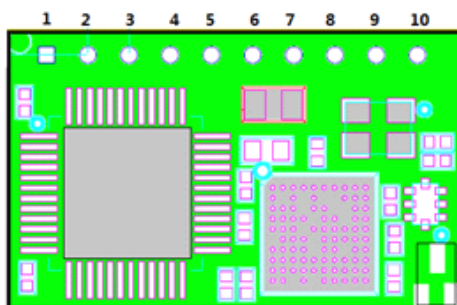

Figure 13 USR-WIFI232-T pin map

Table 5 USR-WIFI232-T Pins Definition

Pin	Description	Net Name	Signal Type	Comments
1	Ground	GND	Power	
2	+3.3V Power	DVDD	Power	3.3V@250mA
3	Module Recovery	nReload	I	Low effective reset input. Pull-up if not use. Can be set to Smart Link Pin
4	Module Reset	nReset	I	Low effective reset input. Pull-up if not use.
5	UART	UART_RX	I	No connect if not use.
6	UART	UART_TX	O	No connect if not use.
7	Power soft switch	PWR_SW	I,PU	"0" – Power Down Mode "1" – Normal mode <b>(Function is reserved)</b>
8	PWM/WPS	PWM_3	I/O	Default WPS function, Can be set to PWM/GPIO18. No connect if not use.
9	PWM/nReady	PWM_2	I/O	Default nReady function, Can be set to PWM/GPIO12. No connect if not use.
10	PWM/nLink	PWM_1	I/O	Default nLink function, Can be set to PWM/GPIO11.

				No connect if not use.
--	--	--	--	------------------------

**< Explanation >:**

I—IN;O—OUT; PU—PULL-UP; I/O—IN/OUT GPIO;

**< The main pin function description >**

**nReset:**

Module reset pin, input GPIO, low effective.

Module nReset need pull-up when module works. If MCU module needs to do a reset operation, pull low for at least 10ms and then pull up.

**nReload:**

Module recovery factory settings pin, input GPIO, low effective.

- 3) After module is powered up, short press this button (Low < 3s) to make the module go into "Smart Link" config mode, waiting for APP to set password and other information.
- 4) After module is powered up, long press this button (Low > 3s) to make the module recover to factory setting.

**nLink:**

Wi-Fi link status indicator pin, output GPIO, low effective. USR strongly suggest customer connect out this pin to LED.

- 3) At "Smart Link" config mode, this LED used to indicate APP to finish setting.
- 4) At normal mode, it's Wi-Fi link status indicator

**nReady:**

Module startup success indicator pin, output GPIO, low effective. Can be connected out to led.

**WPS:**

WPS function start pin, input GPIO, low effective. Can be connected to key.

**UART0\_TX/RX/CTS/RTS:**

UART pin

**GPIO n:**

GPIO which can be controlled by network commands, n is control index number.

**PWM\_N:**

Module PWM signal output pin. Can also be configured as GPIO pin. Can switch PWM\_1 function to nLink, PWM\_2 function to nReady, PWM\_3 function to WPS keys, by AT command "AT + LPTIO = on". "AT + LPTIO = off" is the opposite.

### 3.1.3. USR-WIFI232-G2 Pins Definition

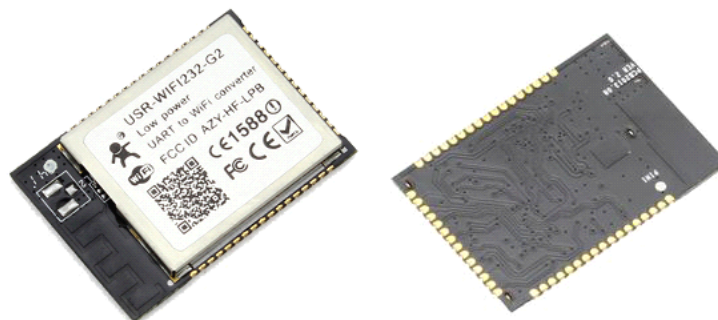

Figure 14 USR-WIFI232-G2 view

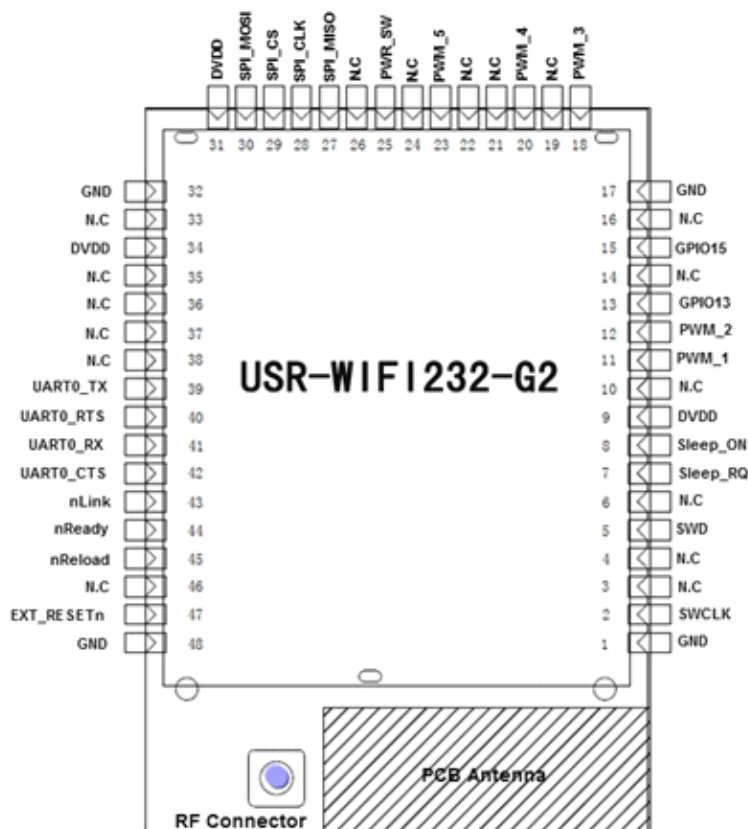

Figure 15 USR-WIFI232-G2 Pin map

Table 6 USR-WIFI232-G2 pin Definition

Pin	Description	Net Name	Signal Type	Comments
1,17,32,48	Ground	GND	Power	
2	Debug	SWCLK	I, PD	Debug functional pin, No connect if not use.
3		N.C		
4		N.C		

5	Debug	SWD	I/O,PU	<b>(Reserved)</b>
6		N.C		
7	Sleep	Sleep_RQ	I,PU	
8	Sleep	Sleep_ON	O	
9	+3.3V Power	DVDD	Power	
10		N.C		No connect
11	PWM/GPIO	PWM_1	I/O	GPIO11, No connect if not use
12	PWM/GPIO	PWM_2	I/O	GPIO12, No connect if not use
13		N.C		No connect
14		N.C		No connect
15	WPS/GPIO	GPIO15	I/O	Default WPS function, Can be set to GPIO15.
16		N.C		No connect
18	PWM/GPIO	PWM_3	I/O	GPIO18, No connect if not use
19		N.C		No connect
20	PWM/GPIO	PWM_4	I/O	GPIO20, No connect if not use
21		N.C		No connect
22		N.C		No connect
23	GPIO	GPIO	I/O	GPIO23, No connect if not use
24		N.C		No connect
25	Power soft switch	PWR_SW	I,PU	"0" – Power Down Mode "1" – Normal mode <b>(Function is reserved)</b>
26		N.C		No connect
27	SPI Data In	SPI_MISO	I	<b>SPI Interface(Reserved)</b>
28	SPI Clock	SPI_CLK	I/O	
29	SPI CS	SPI_CS	I/O	
30	SPI Data Out	SPI_MOSI	O	
31	+3.3V Power	DVDD	Power	
33		N.C		No connect
34	+3.3V Power	DVDD	Power	
35		N.C		No connect
36		N.C		No connect
37		N.C		No connect
38		N.C		No connect
39	UART0	UART0_TX	O	UART Interface
40	UART0	UART0_RTS	I/O	
41	UART0	UART0_RX	I	
42	UART0	UART0_CTS	I/O	
43	Wi-Fi Status	nLink	O	0- Wi-Fi Link

				1- No WIFI Link No connect if not use.
44	Module Boot Up Indicator	nReady	O	0 – Boot-up OK; 1 – Boot-up No OK; No connect if not use.
45	Module recovery	nReload	I	Low effective reset input. Pull-up if not use. Can be set to Smart Link Pin
46		N.C		No connect
47	Module Reset	nReset	I	Low effective reset input. Pull-up if not use.

**< Explanation >:**

I—IN; O—OUT; PU—PULL-UP; I/O—IN/OUT GPIO;

**< The main pin function description >**

**nReset:**

Module reset pin, input GPIO, low effective.

Module nReset need pull-up when module works. If MCU module needs to do a reset operation, pull low for at least 10ms and then pull up.

**nReload:**

Module recovery factory settings pin, input GPIO, low effective.

- 5) After module is powered up, short press this button (Low < 3s) to make the module go into "Smart Link" config mode, waiting for APP to set password and other information.
- 6) After module is powered up, long press this button (Low > 3s) to make the module recover to factory setting.

**nLink:**

Wi-Fi link status indicator pin, output GPIO, low effective. USR strongly suggest customer connect out this pin to LED.

- 5) At "Smart Link" config mode, this LED used to indicate APP to finish setting.
- 6) At normal mode, it's Wi-Fi link status indicator

**nReady:**

Module startup success indicator pin, output GPIO, low effective. Can be connected out to led.

**WPS:**

WPS function start pin, input GPIO, low effective. Can be connected to key.

**UART0\_TX/RX/CTS/RTS:**

UART pin

**GPIO n:**

GPIO which can be controlled by network commands, n is control index number.

**PWM\_N:**

Module PWM signal output pin. Can also be configured as GPIO pin.

### 3.1.4. USR-WIFI232-H Pins Definition

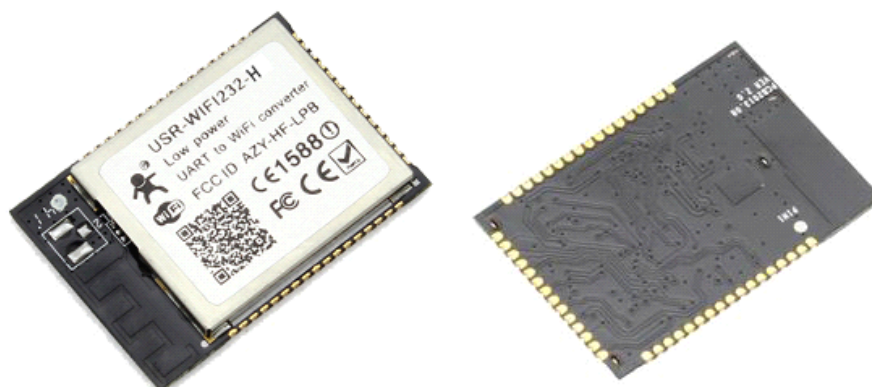

Figure 16 USR-WIFI232-H view

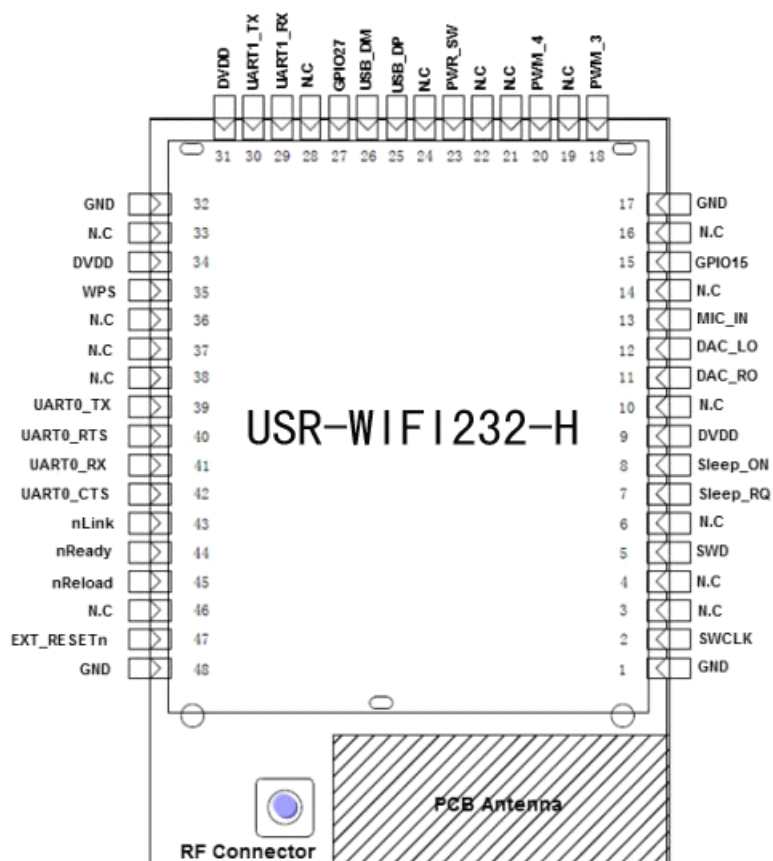

Figure 17 USR-WIFI232-H Pin map

Table 7 USR-WIFI232-H pin Definition

Pin	Description	Net Name	Signal Type	Comments
1,17,32,48	Ground	GND	Power	
2	Debug	SWCLK	I, PD	Debug functional pin,

3		N.C		No connect if not use.
4		N.C		
5	Debug	SWD	I/O,PU	
6		N.C		
7	GPIO	Sleep_RQ	I,PU	GPIO7, No connect if not use
8	GPIO	Sleep_ON	O	GPIO8, No connect if not use
9	+3.3V Power	DVDD	Power	
10		N.C		No connect
11	Speaker OUT R	DAC_RO	Analog	
12	Speaker OUT L	DAC_RL	Analog	
13	MIC INPUT	MIC_IN	Analog	
14		N.C		No connect
15	GPIO	GPIO15	I/O	GPIO15, No connect if not use
16		N.C		No connect
18	PWM/GPIO	PWM_3	I/O	GPIO18, No connect if not use
19		N.C		No connect
20	PWM/GPIO	PWM_4	I/O	GPIO20, No connect if not use
21		N.C		No connect
22		N.C		No connect
23		N.C		No connect
24		N.C		No connect
25	USB1.1 D+	USB_DP	I/O	GPIO25, No connect if not use
26	USB1.1 D-	USB_DM	I/O	GPIO26, No connect if not use
27	GPIO	GPIO27	I/O	GPIO27, No connect if not use
28		N.C		No connect
29	UART1	UART1_RX	I	GPIO29, No connect if not use
30	UART1	UART1_TX	O	GPIO30, No connect if not use
31	+3.3V Power	DVDD	Power	
33		N.C		No connect
34	+3.3V Power	DVDD	Power	
35	WPS/GPIO	WPS	I/O	Default WPS function, Can be set to GPIO35.
36		N.C		No connect
37		N.C		No connect
38		N.C		No connect
39	UART0	UART0_TX	O	UART Interface
40	UART0	UART0_RTS	I/O	
41	UART0	UART0_RX	I	
42	UART0	UART0_CTS	I/O	
43	Wi-Fi Status	nLink	O	0- Wi-Fi Link



				1- No WIFI Link No connect if not use.
44	Module Boot Up Indicator	nReady	O	0 – Boot-up OK; 1 – Boot-up No OK; No connect if not use.
45	Module recovery	nReload	I	Low effective reset input. Pull-up if not use. Can be set to Smart Link Pin
46		N.C		No connect
47	Module Reset	nReset	I	Low effective reset input. Pull-up if not use.

**< Explanation >:**

I—IN; O—OUT; PU—PULL-UP; I/O—IN/OUT GPIO;

**< The main pin function description >**

**nReset:**

Module reset pin, input GPIO, low effective.

Module nReset need pull-up when module works. If MCU module needs to do a reset operation, pull low for at least 10ms and then pull up.

**nReload:**

Module recovery factory settings pin, input GPIO, low effective.

- 7) After module is powered up, short press this button (Low < 3s) to make the module go into "Smart Link" config mode, waiting for APP to set password and other information.
- 8) After module is powered up, long press this button (Low > 3s) to make the module recover to factory setting.

**nLink:**

Wi-Fi link status indicator pin, output GPIO, low effective. USR strongly suggest customer connect out this pin to LED.

- 7) At "Smart Link" config mode, this LED used to indicate APP to finish setting.
- 8) At normal mode, it's Wi-Fi link status indicator

**nReady:**

Module startup success indicator pin, output GPIO, low effective. Can be connected out to led.

**WPS:**

WPS function start pin, input GPIO, low effective. Can be connected to key.

**UART0\_TX/RX/CTS/RTS:**

UART0 pin

**PWM/GPIO:**

GPIO/PWM which can be controlled by network commands, now **this function is reserved.**

**Speaker Out/MIC Input:**

Be used to Network Configuration by Audio.

**UART1\_TX/RX:**

**UART1 is reserved now.**

## 3.2 Electrical Characteristics

Table 8 Electrical Characteristics

Parameter	Condition	Min.	Typ.	Max.	Unit
Storage temperature range		-45	-	125	°C
Maximum soldering temperature	IPC/JEDEC J-STD-020		-	260	°C
Supply voltage		0	-	3.6	V
Voltage on any I/O pin		0	-	3.3	V
ESD (Human Body Model HBM)	TAMB=25°C		-	2	KV
ESD (Charged Device Model, CDM)	TAMB=25°C		-	1	KV

Table 9 Power Supply &amp; Power Consumption

Parameter	Condition	Min.	Typ.	Max.	Unit
Operating Supply voltage		3.0	3.3	3.6	V
Supply current, peak	Continuous Tx		200		mA
Supply current, IEEE PS	DTIM=100ms		12		mA
Output high voltage	Sourcing 6mA	2.8			V
Output low voltage	Sinking 6mA			0.2	V
Input high voltage		2.2			V
Input low voltage				0.8	V

## 3.3 Mechanical Size

### 3.3.1 USR-WIFI232-S

USR-WIFI232-S modules physical size (Unit: mm) as follows:

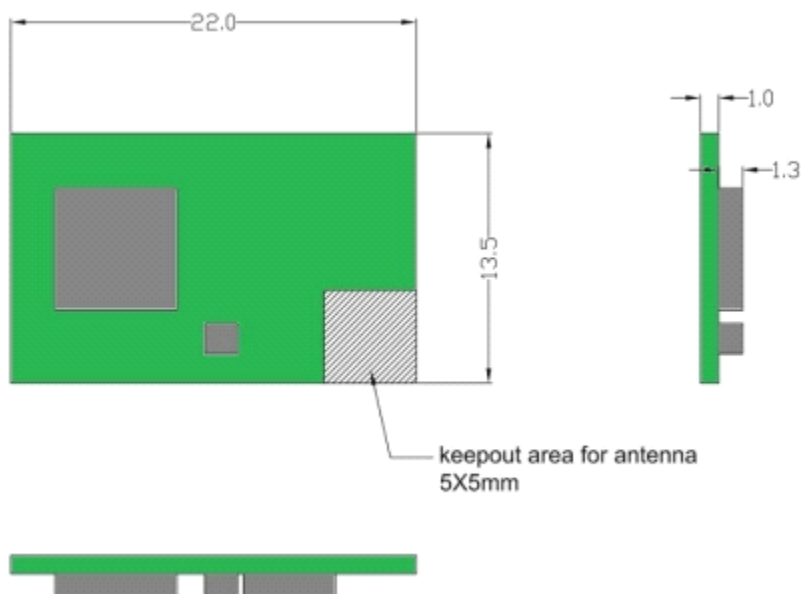

Figure 18 USR-WIFI232-S Mechanical Size

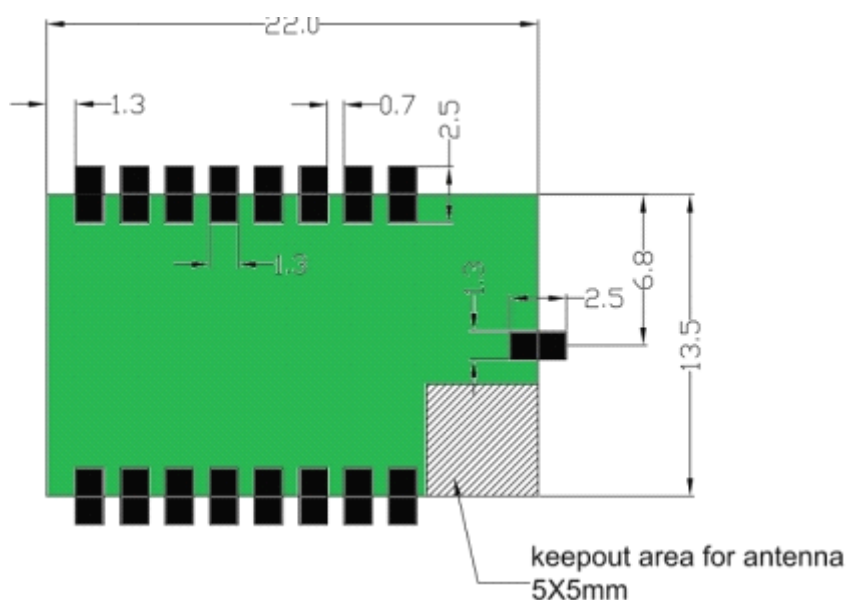

Figure 19 USR-WIFI232-S PCB Symbol Size

### 3.3.2 USR-WIFI232-T

USR-WIFI232-T modules physical size (Unit: mm) as follows:

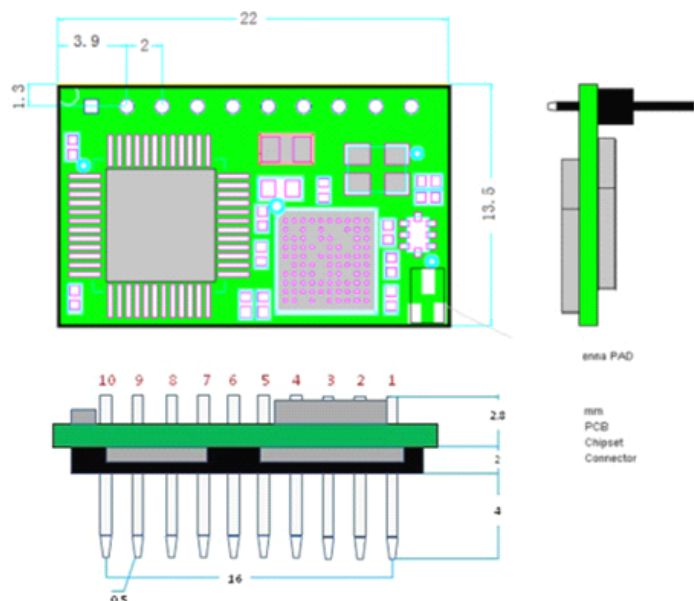

Figure 20 USR-WIFI232-T Mechanical Size

### 3.3.3 USR-WIFI232-G2/H

USR-WIFI232-G2/H modules physical size (Unit: mm) as follows:

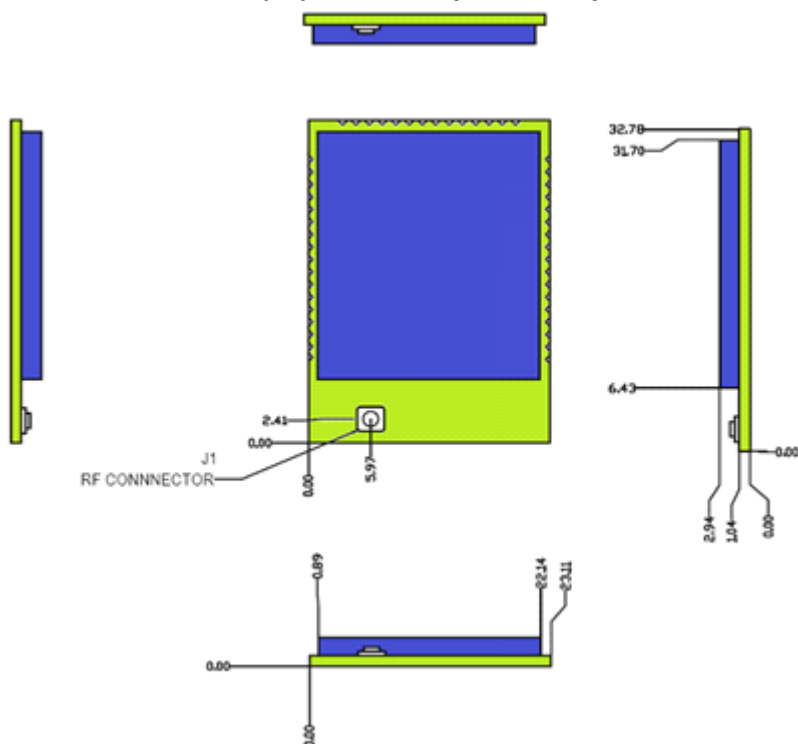

Figure 21 USR-WIFI232-G2/H PCB Symbol Size

USR-WIFI232-G2/H modules PCB footprint size (Unit:mm) as follows:

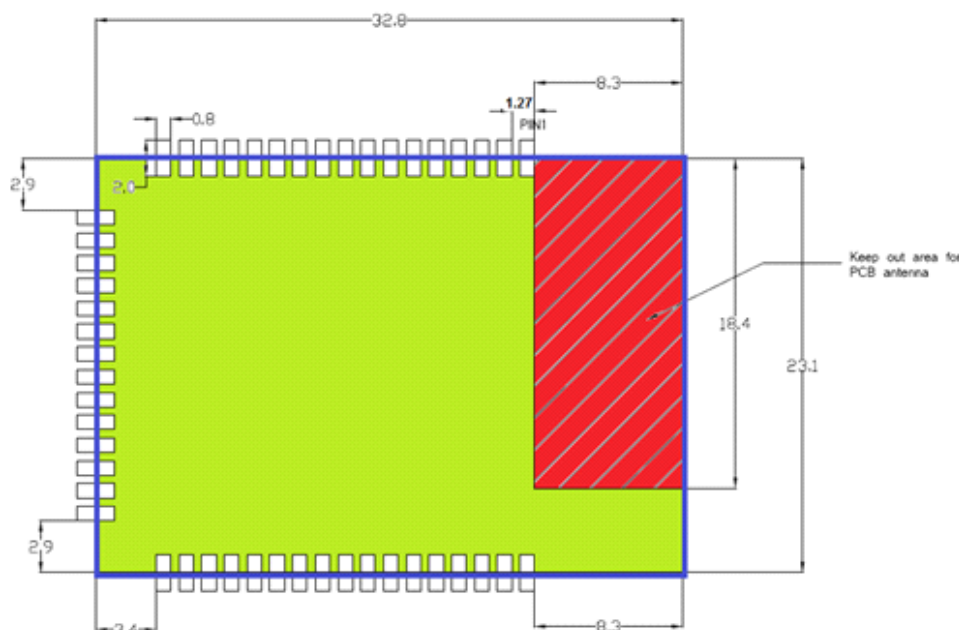

Figure 22 USR-WIFI232-G2/H PCB Symbol Size

## 3.4 Antenna

### 3.4.1 USR-WIFI232-S

USR-WIFI232-S has two versions, respectively supports internal antenna and external SMA antenna.

#### 1) Internal antenna version USR-WIFI232-Sa

When customer select internal antenna, you shall comply with following antenna design rules and module location suggestions:

- For customer PCB, grey color region (5\*5mm) can't put componet or paste GND net;
- Antenna must away from metal or high components at least 10mm
- Antenna can't be shieldedby any meal enclosure; All cover, include plastic,shall away from antenna at least 10mm

USR suggest USR-WIFI232-G2 module better locate in following region at customer board, which to reduce the effect to antenna and wireless signal, and better consult USR technical people when you structure your module placement and PCB layout.

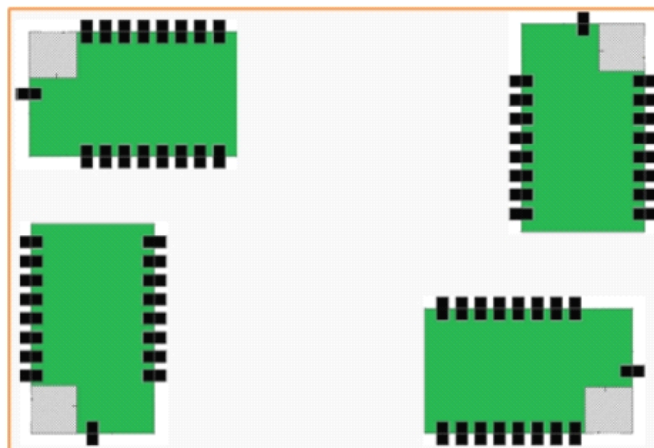

Figure 23 USR-WIFI232-Sa Suggested Module Placement Region

## 2) external antenna version USR-WIFI232-Sb

If user select external antenna, USR-WIFI232- Sb modules must be connected to the 2.4G antenna according to IEEE 802.11b/g/n standards.

The antenna parameters required as follows:

Table 10 USR-WIFI232-Sb External Antenna Parameters

Item	Parameters
Frequency range	2.4~2.5GHz
Impedance	50 Ohm
VSWR	2 (Max)
Return Loss	-10dB (Max)
Connector Type	SMA connector

## 3.4.2 USR-WIFI232-T

USR-WIFI232-T support I-PEX connector external antenna, modules must be connected to the 2.4G antenna according to IEEE 802.11b/g/n standards.

The antenna parameters required as follows:

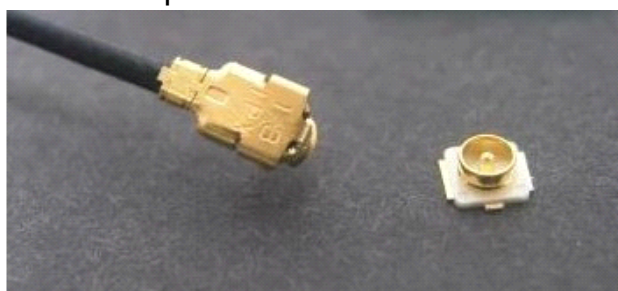

Figure 24 USR-WIFI232-T I-PEX connector

Table 11 USR-WIFI232-T External Antenna Parameters

Item	Parameters
Frequency range	2.4~2.5GHz
Impedance	50 Ohm
VSWR	2 (Max)

Return Loss	-10dB (Max)
Connector Type	I-PEX connector

### 3.4.3 USR-WIFI232-G2/H

USR-WIFI232-G2/H has two versions, respectively supports Internal antenna and external I-PEX antenna.

#### 1) Internal antenna version USR-WIFI232-G2a/Ha

When customer select internal antenna, you shall comply with following antenna design rules and module location suggestions:

- For customer PCB, RED color region (8.3x18.4mm) can't put componet or paste GND net
- Antenna must away from metal or high components at least 10mm
- Antenna can't be shieldedby any meal enclosure; All cover, include plastic, shall away from antenna at least 10mm

USR suggest USR-WIFI232-G2a/Ha module better locate in following region at customer board, which to reduce the effect to antenna and wireless signal, and better consult USR technical people when you structure your module placement and PCB layout.

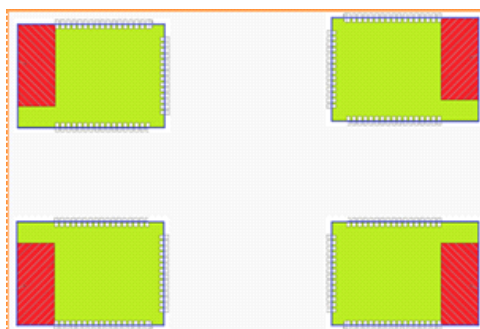

Figure 25 USR-WIFI232-G2a/Ha Suggested Module Placement Region

#### 2) External antenna version USR-WIFI232-G2b/Hb

If user select external antenna, USR-WIFI232- G2b/Hb modules must be connected to the 2.4G antenna according to IEEE 802.11b/g/n standards.

The antenna parameters required as follows:

Table 12 USR-WIFI232-G2b/Hb External Antenna Parameters

Item	Parameters
Frequency range	2.4~2.5GHz
Impedance	50 Ohm
VSWR	2 (Max)
Return Loss	-10dB (Max)
Connector Type	I-PEX connector

### 3.5 Evaluation Kit

USR provides USR-WIFI232-S/T/G2/H evaluation kit to promote user to comprehend the product and develop the detailed application. The evaluation kit shown as below, user can connect to module with the RS-232 UART, and Wireless port to configure the parameters, manage the module or do the some functional tests.

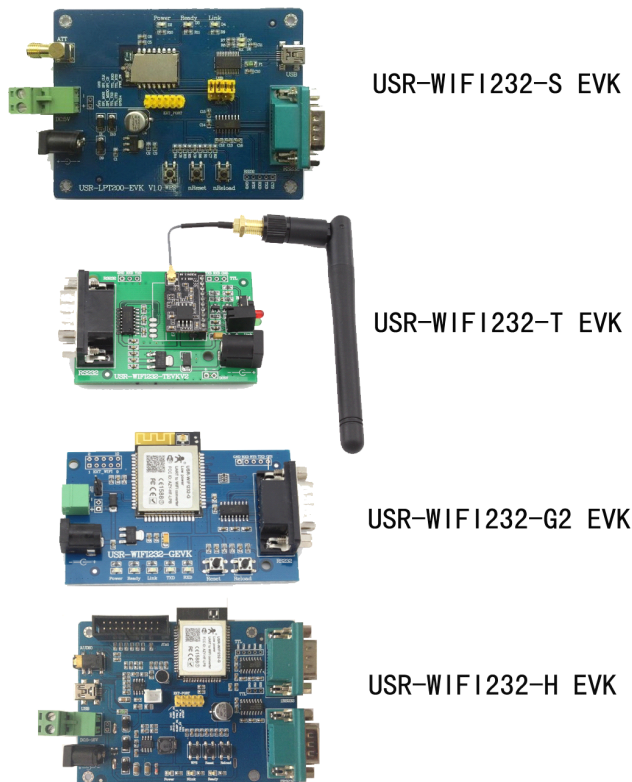

Figure 26 USR-WIFI232-S/T/G2/H Evaluation Kit

The external interface description for evaluation kit as follows:

Table 13 USR-WIFI232-S/T/G2/H Evaluation Kit Interface Description

Function	Name	Description
External Interface	RS232	Main data/command RS-232 interface
	DC5-18V	DC jack for power in, 5~18V input.
Button	nReset	Used to reset the module
	nReload	Smartlink or Restore factory default configuration
LED	nLink	WiFi LINK Indicator
	nReady	Module Bootup Ready Indicator



## 3.6 Typical Application Hardware

### 3.6.1 UART Application Hardware

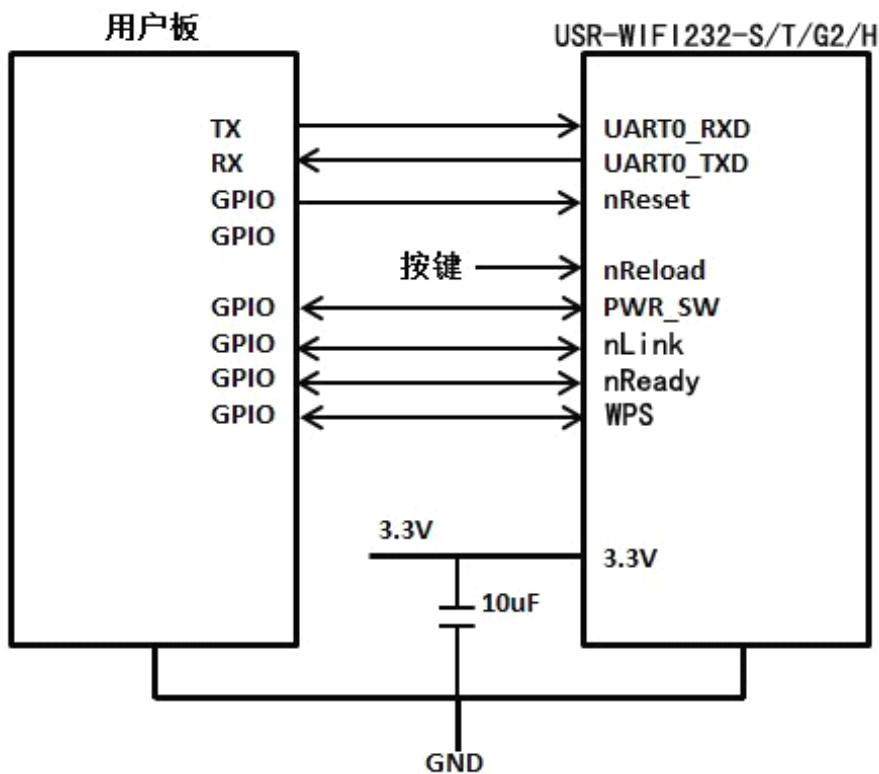

Figure 27 USR-WIFI232-S/T/G2/H UART Application Hardware

### 3.6.2 PWM/GPIO Application Hardware

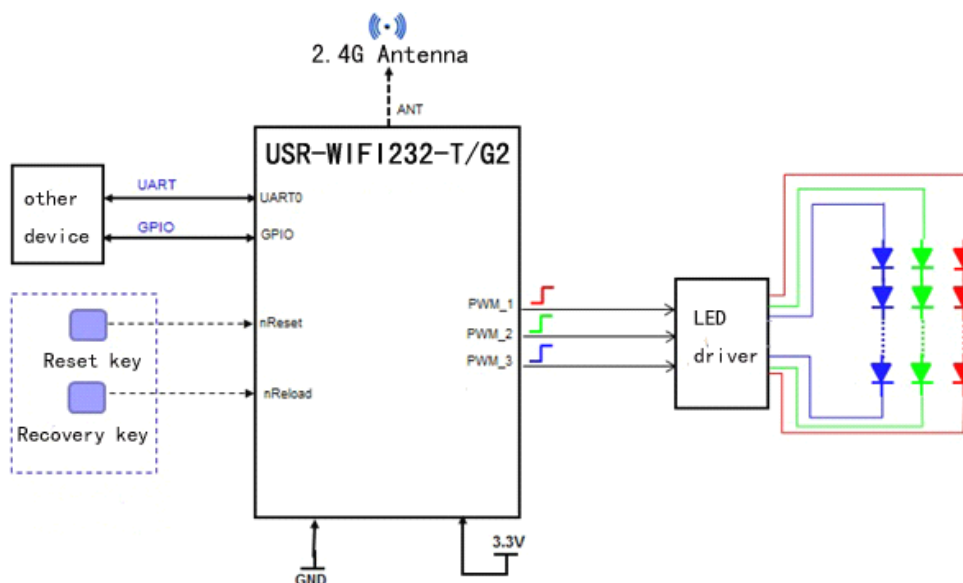

Figure 28 USR-WIFI232-T/G2 PWM/GPIO Application Hardware

## 4、Modules function description

### 4.1 Work Mode

USR-WIFI232-S/T/G2/H have three work modes: throughput mode, command mode, PWM/GPIO mode. The switching method of work mode is in 5th Chapter.

- Throughput mode  
In this mode, the module can transparently transmit data between the common serial device and network device.
- Command mode  
In this mode, the user can query and set the serial port and network parameters on the module through the AT command.
- PWM/GPIO mode  
In this mode, the user can realize the control of the PWM/GPIO through the network command.

#### 4.1.1 Throughput mode

##### 1. Throughput mode brief introduction

The benefit of this mode is achieving a plug and play serial data port, and reducing user complexity furthest. In this mode, user only needs to configure the necessary parameters. After power on, the module can automatically connect to the default wireless network and server.

As in this mode, the module's serial port always works in the throughput mode, so users only need to think of it as a virtual serial cable, and send and receive data as using a simple serial. In other words, the serial cable of users' original serial devices is directly replaced with the module; user devices can be easy for wireless data transmission without any changes.

Throughput mode can be fully compatible with user's original software platform and reduce the software development effort for integrated wireless data transmission.

The parameters which need to be configured include:

- Wireless Network Parameters
  - ◆ Wireless Network Name (SSID)
  - ◆ Security Mode
  - ◆ Encryption Key
- TCP/UDP Linking Parameters
  - ◆ Protocol Type
  - ◆ Link Type (Server or Client)
  - ◆ Target Port ID Number
  - ◆ Target Port IP Address
- Serial Port Parameters
  - ◆ Baud Rate

- ◆ Data Bit
- ◆ Parity (Check) Bit
- ◆ Stop Bit
- ◆ Hardware Flow Control

## 2. UART Frame Scheme

### 1) UART Free-Frame

If user select open this function, module will check the intervals between any two bytes when receiving UART data. If this interval time exceeds defined value (250ms default), the module will think it as the end of one frame and transfer this free-frame to WiFi port, or else the module will receive UART data until 1000 bytes, then transfer 1000 bytes frame to WiFi port.

The module's default interval time is normal(250ms). User can also set this interval time to fast (200ms) through AT command: AT+UARTTE=fast/normal. When the interval time is fast, user have to consider if user MCU can send UART data with 10ms interval; When the interval time is normal, user have to consider if user MCU can send UART data with 50ms interval; or else the UART data may be divide as fragment.

Through AT command: user can set the interval time: fast (200ms) and normal (250ms).

### 2) UART Auto-Frame

If the length of serial data is fixed, user can select UART Auto-Frame achieve the highest transmission efficiency. If user select open this function and setting auto-frame trigger length and auto-frame trigger time parameters, then module will auto frame the data which received from UART port and transmit to the network as pre-defined data structure.

- Auto-frame trigger length: If The data length that module received from serial reach Auto-frame trigger length,the module will transmute the data to the network.
- Auto-frame trigger time: After the trigger time, if UART port received data can't reach auto-frame trigger length, then module will transmit available data to the network and bypass the auto-frame trigger length condition.

Auto-frame trigger time calculate from the first byte that the module receives from the serial port. As shown below:

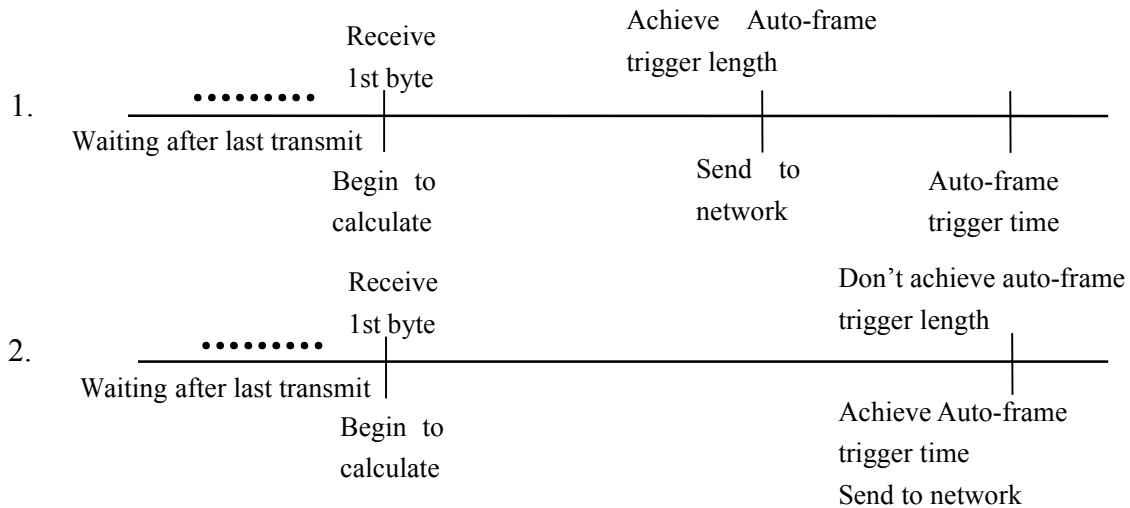

Figure 29 UART Auto-Frame

Detailed UART auto-frame function can refer to AT+instruction set "UARTF/UARTFT/UARTFL" introduction.

## 4.1.2 Command Mode

In this mode, the module no longer transparent transmit data. Now the serial port is used to receive AT commands. User can send AT commands to the module through the serial port, to query and set the module's parameters about serial port, network, etc. The method to enter Command Mode from throughput mode and the explanation of AT commands, are in 5<sup>th</sup> Chapter.

## 4.1.3 GPIO/PWM Mode

USR-WIFI232 module can provide multiple PWM and GPIO function pin for GPIO and PWM-based control applications, the following table is the pin mapping table. **USR-WIFI232-H don't have this function.**

Table 14 USR-WIFI232-S GPIO/PWM pin map

Pin Number	Configure d Function	PWM/GPIO Index number	Default Setting	Type
9	GPIO	23	GPIO	I/O

Table 15 USR-WIFI232-T GPIO/PWM pin map

Pin Number	Configured Function	PWM/GPIO Index number	Default Setting	Type
8	PWM/GPIO	18	WPS	I/O
9	PWM/GPIO	12	nReady	I/O
10	PWM/GPIO	11	nLink	I/O

Table 16 USR-WIFI232-G2 GPIO/PWM pin map

Pin Number	Configured Function	PWM/GPIO Index number	Default Setting	Type
11	PWM/GPIO	11	PWM	I/O

12	PWM/GPIO	12	PWM	I/O
15	GPIO	15	WPS	I/O
18	PWM/GPIO	18	PWM	I/O
20	PWM/GPIO	20	PWM	I/O
23	GPIO	23	GPIO	I/O

PWM/GPIO function and transparent transmit, nLink, nReady, WPS function can't be used simultaneously. User can select the function by AT command: AT + TMODE and AT + LPTIO. The setting parameters are as follows.

Module	Function	AT+TMODE	AT+LPTIO
-S	GPIO/PWM	pwm	off
	Transparent transmission, nLink, nReady, WPS	throughput	lpt200
-T	GPIO/PWM	pwm	off
	Transparent transmission, nLink, nReady, WPS	throughput	on
-G2	GPIO/PWM	pwm	lpt200
	Transparent transmission, nLink, nReady, WPS	throughput	off

**Note:** After setting, restart the module to take effect.

When module works at PWM/GPIO mode, PC and other devices can setup connection (TCP/UDP) through WiFi, then read/control PWM/GPIO status through command data. The basic commands are as follows. Detailed usage, please refer to Appendix B.

- GPIO n OUT 0: Set GPIO n output 0, Response GPIO OK or GPIO NOK;
- GPIO n OUT 1: Set GPIO n output 1, Response GPIO OK or GPIO NOK;
- GPIO n GET: Read GPIO n pin status, Response +ok=1 or GPIO NOK
- GPIO n SET: Save GPIO n set, Response GPIO OK or GPIO NOK
- PWM n frequency duty: Set PWM n Channel output, Response GPIO OK or GPIO NOK
- PWM n GET: Read PWM n Channel set, Response +ok=frequency duty or PWM NOK
- PWM n SET: Save PWM n Channel set, Response PWM OK or PWM NOK

## 4.2 Wireless Networking

USR-WIFI232-S/T/G2/H module can be configured as both wireless STA and AP base on network type. can provide a very flexible method for users and network topology.

### Notes:

AP: that is the wireless Access Point, the founder of a wireless network and the centre of the network nodes. The wireless router we use at home or in office may be an AP.

STA: short for Station, each terminal connects to a wireless network (such as laptops, PDA and other networking devices) can be called with a STA device.

## 4.2.1 STA WI-FI Mode

Module as the STA is one of the most common networking method, as shown below, the network consists of a router AP and several STA nodes, In this network, AP is the center, The communication between STA node is forwarded by AP.

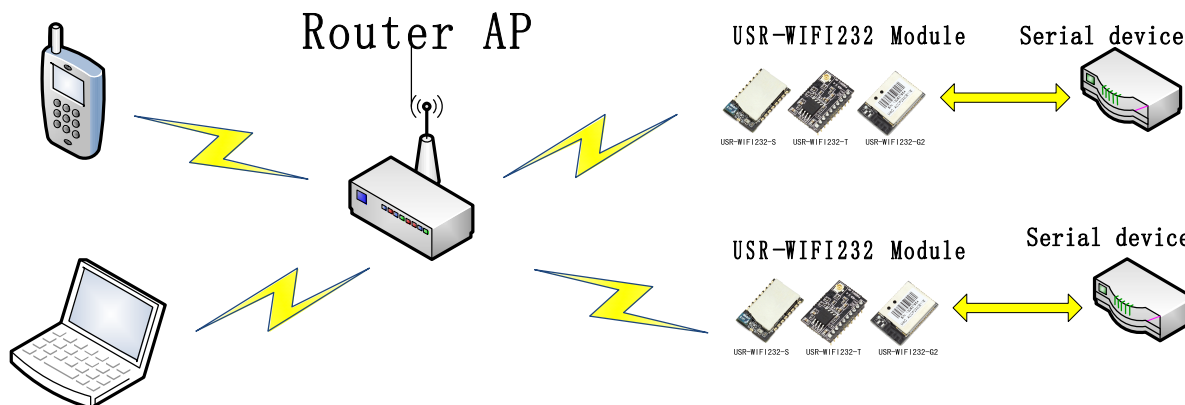

Figure 30 USR-WIFI232-S/T/G2/H STA WI-FI Mode

## 4.2.2 AP WI-FI Mode

In AP WI-FI Mode, the phone / PAD / computer can quickly connect to the serial device to transfer data or control the device, without any configuration. Also, you can login module's built-in web pages to set parameters.

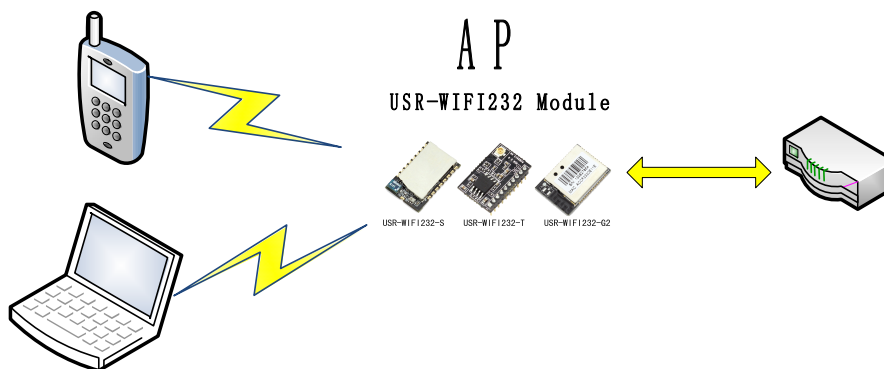

Figure 31 USR-WIFI232-S/T/G2/H AP WI-FI Mode

### Note:

In AP WI-FI mode, can only support a maximum of two STA device access.

## 4.2.3 AP+STA WI-FI Mode

In AP+STA WI-FI Mode, the module supports both an AP interface and an STA interface. As shown below:

STA connect to the router and connect to the network server via a TCP/UDP connection.

AP is turned on, the phone/PAD, etc. can connect to the module to control serial device or set module's parameters.

In AP+STA WI-FI mode, user can easily examine and control the serial device by the phone / PAD, without altering its original network settings.

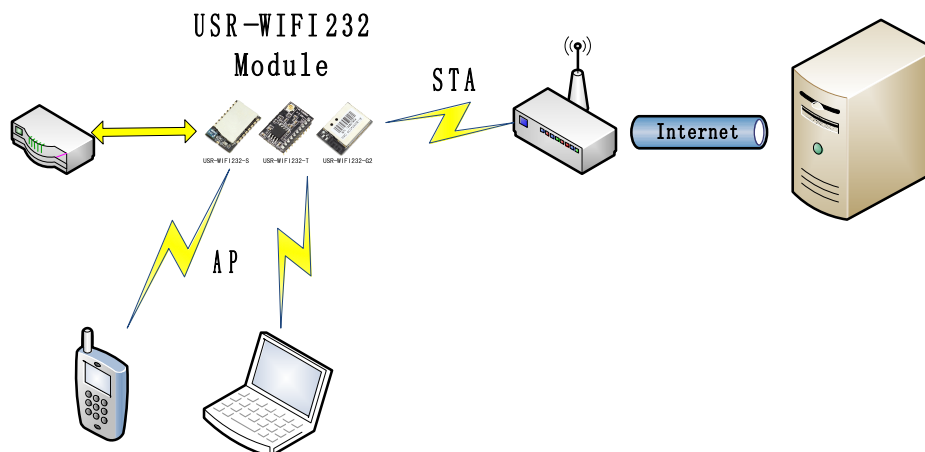

Figure 32 USR-WIFI232-S/T/G2/H AP+STA WI-FI Mode

### Note:

In AP+STA WI-FI mode, AP can only support a maximum of one STA device access.

## 4.2.4 Encryption

Encryption is a method of scrambling a message that makes it unreadable to unwanted parties, adding a degree of secure communications. There are different protocols for providing encryption, and the USR-WIFI232-S/T/G2 module supports following:

- WEP
- WPA-PSK/TKIP
- WPA-PSK/AES
- WPA2-PSK/TKIP
- WPA2-PSK/AES

## 4.3 Socket Communication

USR-WIFI232-S/T/G2/H module has two TCP/UDP Socket: Socket A and Socket B. Serial data written to the module, will be sent to the Socket A and B simultaneously; TCP/UDP data that module receives through either Socket A or B, will be sent to the serial port.

Dual Socket through different settings, you can achieve a variety of network interconnect. When the module shipped only open Socket A, Socket B default is not to connect, if the user needs to use, please set by AT commands.

### 4.3.1 Socket A

Socket A has four work mode: TCP Server, TCP Client, UDP Client, UDP Server. The setting method, please refer to the AT+NETP command instruction.

When Socket A configured as TCP Server, it supports Multi-TCP link connection, and maximum 5 TCP clients permitted to connect to Socket A.

Multi-TCP link connection will work as following structure:

Upstream: All dates from different TCP connection or client will be transmitted to the serial port as a sequence.

Downstream: All data from serial port (user) will be duplicate and broadcast to every TCP connection or client.

Detailed multi-TCP link data transmission structure as following figure:

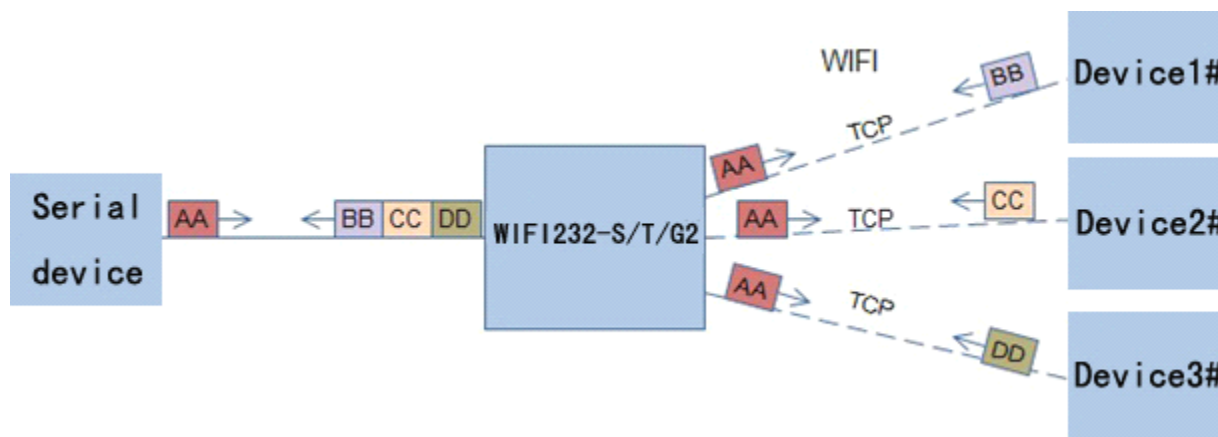

Figure 33 Multi-TCP Link Data Transmission Structure

### 4.3.2 Socket B

Socket B has three work mode: TCP Client, UDP Client, UDP Server. the setting method, please refer to the AT + SOCKB command instruction.

With variety work mode, socket B can provide users with flexible data transfer methods. For example, Socket B can be set to UDP Server mode for LAN equipment to search modules. Socket B also can be set to TCP Client connect to a remote server in order to achieve remote control.

## 4.4 Network configuration by audio

### 4.4.1. Introduction

Network configuration by audio is USR patent technology. By adding audio decoding unit on the WIFI module, to receive audio information that the intelligent terminal sends, User can configurate network parameters via intelligent terminal.

User input router password information into the intelligent terminal application, then intelligent terminal application would encode the password to audio information



and send. The WIFI module with the audio decoding unit receive the audio information, and decode it to the password, and complete network configuration

The whole network configuration don't required user have any wireless network technology background, user can implement the WIFI module or products to STA model correctly connected to the WIFI router and realizing the networking success 100%.

#### 4.4.2. Peripheral circuit

User need to connect a MIC to Pin13(MIC\_IN),as following: the microphone can be the standard microphone (0.1RMB), such as the reference design on EM-6050P or F6050AP-STN.

Audio configuration requires the intelligent terminal as close as possible to the microphone, in order to ensure the success rate of 100%, distance cannot be more than 30cm, and the intermediate should have no obstacle soundproof.

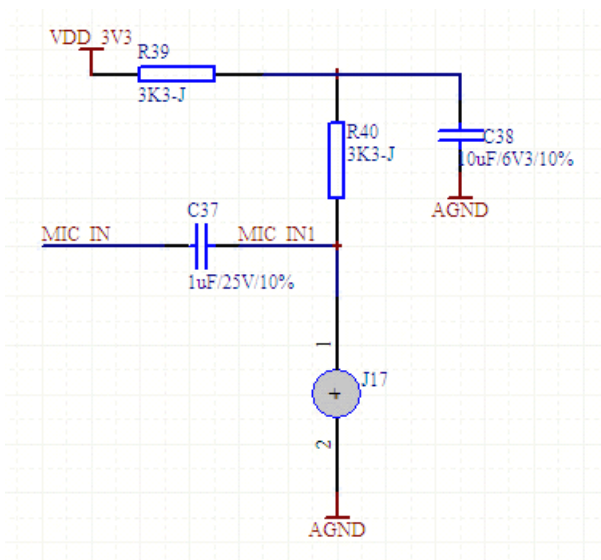

Figure 34 Peripheral circuit

#### 4.5 Parameter configuration

USR-WIFI232-T/G2 supports configurate parameter by Web and AT command, USR-WIFI232-S only supports configurate parameter by AT command.

- Web: user can login module's built-in web to configure the parameters.
- AT command: user can send AT command to module through the serial port to configurate parameters.

Two methods of configuration parameters, please refer to Chapter 5 explains.

#### 4.6 Firmware and web upgrade

USR-WIFI232-S/T/G2/H supports upgrade firmware and web over wireless. USR-WIFI232-T/G2/H upgrade method can refer to Section 5.1.9 firmware upgrade

page. Besides, you can login <http://10.10.100.254/iweb.html> to update firmware and web. Diagram is as follows:



The screenshot shows a web interface for upgrading firmware and a customized webpage. It contains two sections:

- Upgrade firmware:** A file selection area with a button labeled "选择文件" (Select File) and the text "未选择文件" (No file selected). Below it is an "Upload" button.
- Upgrade customized webpage:** A file selection area with a button labeled "选择文件" (Select File) and the text "未选择文件" (No file selected). Below it is an "Upload" button.

Figure 35 Upgrade page

**Note:**

Before any firmware upgrade, be sure to contact USR, or else it may result in permanent damage to the module.

## 5、Module Parameter configuration

USR-WIFI232 modules support two methods of Parameter configuration: web and AT command,the following will describe the detail of two methods.

### 5.1 Web

#### 5.1.1 Web Brief Description

When first use USR-WIFI232 modules, user may need some configuration. User can connect to USR-WIFI232 module's wireless interface with following default setting information and configure the module through laptop.

Table 17 USR-WIFI232-T/G2/H Web Access Default Setting

Parameters	Default Setting
SSID	USR-WIFI232-T/G2/H
IP Address	10.10.100.254
Subnet Mask	255.255.255.0
User Name	admin
Password	admin

#### 5.1.2 Open Web Management Interface

- Step 1 Connect laptop to SSID USR-WIFI232-T/G2/H of module via wireless LAN card;
- Step 2 After wireless connection OK. Open Wen browser and access "http://10.10.100.254";
- Step 3 Then input user name and password in the page as following and click "OK" button.

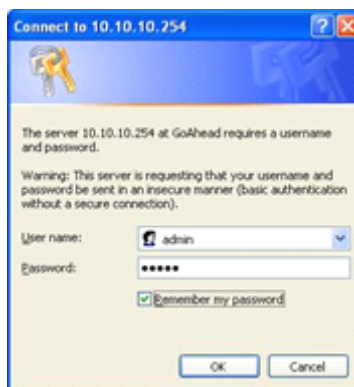

Figure 36 Open Web Management page

The USR-WIFI232-T/G2/H web management page support English and Chinese language. User can select language environment at the top right corner and click "Apply" button.

The main menu include nine pages: "System", "Work Mode", "STA Setting", "AP Setting", "Other Setting", "Account", "Upgrade SW", "Restart", "Restore"

### 5.1.3 System Page

At this page, user can check current device's important information and status such as: device ID (MID), software version, wireless work mode and related Wi-Fi parameters.

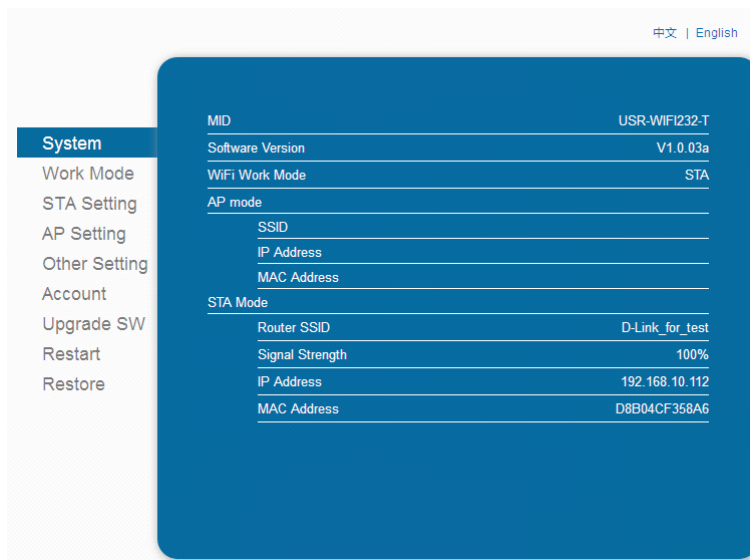

Figure 37 System Web Page

### 5.1.4 Work Mode Page

USR-WIFI232- T/G2/H module can works at AP mode to simplify user's configuration, can also works at STA to connect remote server through AP router. Also, it can configure at AP+STA mode which provide very flexible application for customers

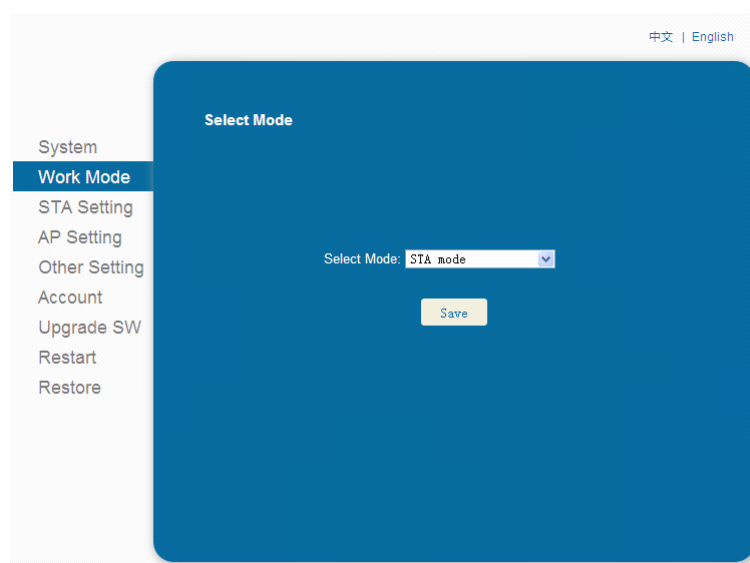

Figure 38 Work Mode Page

## 5.1.5 STA Setting Page

User can push "Scan" button to auto search Wi-Fi AP router nearby, and can connect with associate AP through some settings. Please note the encryption information input here must be fully same with Wi-Fi AP router's configuration, and then it can link with AP correctly.

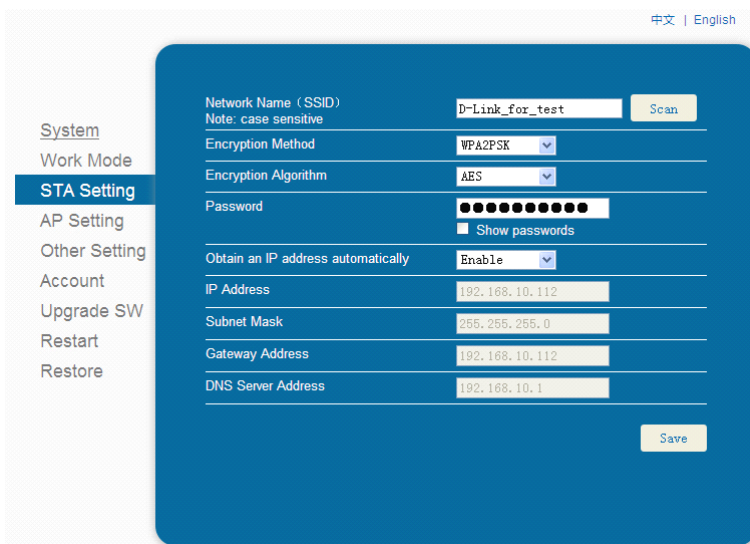
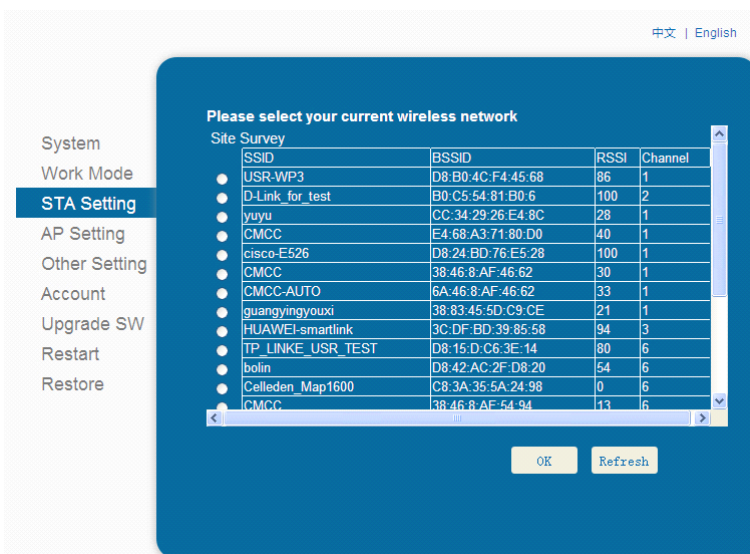

Figure 39 STA Setting Page



SSID	BSSID	RSSI	Channel
USR-WP3	D8:B0:4C:F4:45:68	86	1
D-Link_for_test	B0:C5:54:81:B0:6	100	2
yuyu	CC:34:29:26:E4:8C	28	1
CMCC	E4:68:A3:71:80:D0	40	1
cisco-E526	D8:24:BD:76:E5:28	100	1
CMCC	38:46:8:AF:46:62	30	1
CMCC-AUTO	6A:46:8:AF:46:62	33	1
guangyingyouxi	38:83:45:5D:C9:CE	21	1
HUAWEL-smartlink	3C:DF:BD:39:85:58	94	3
TP_LINKE_USR_TEST	D8:15:D:C6:3E:14	80	6
bolin	D8:42:AC:2F:D8:20	54	6
Celleden_Map1600	C8:3A:35:5A:24:98	0	6
CMCC	38:46:8:AF:54:94	13	6

Figure 40 SSID scan page

## 5.1.6 AP Setting Page

When user select module works at AP and AP+STA mode, then need setting this page and provide wireless and network parameters. Most of the system support DHCP to achieve IP address, so we suggest to "Enable" DHCP server in most applications.

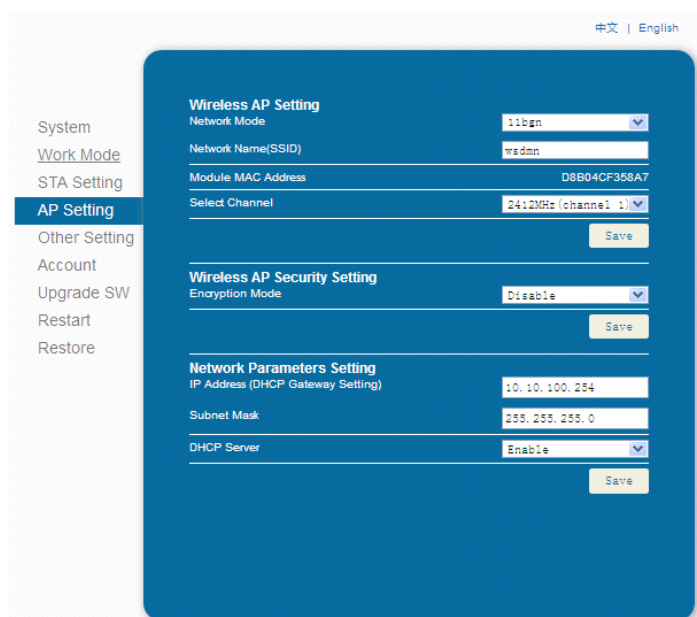

Figure 41 AP Setting Page

### 5.1.7 Other Setting Page

USR-WIFI232-T/G2/H usually works at throughput mode. At this mode, the user device which connected with USR-WIFI232-T/G2/H will connect and communicate with remote PC or server. At this page, user need setting serial port communication parameters and defines TCP related protocol parameters.

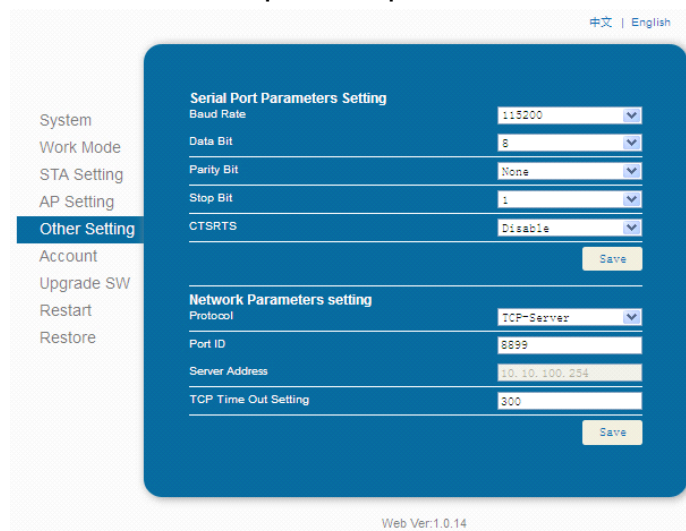

Figure 42 Other Setting Page

### 5.1.8 Account Management Page

This page set web server's user name and password.

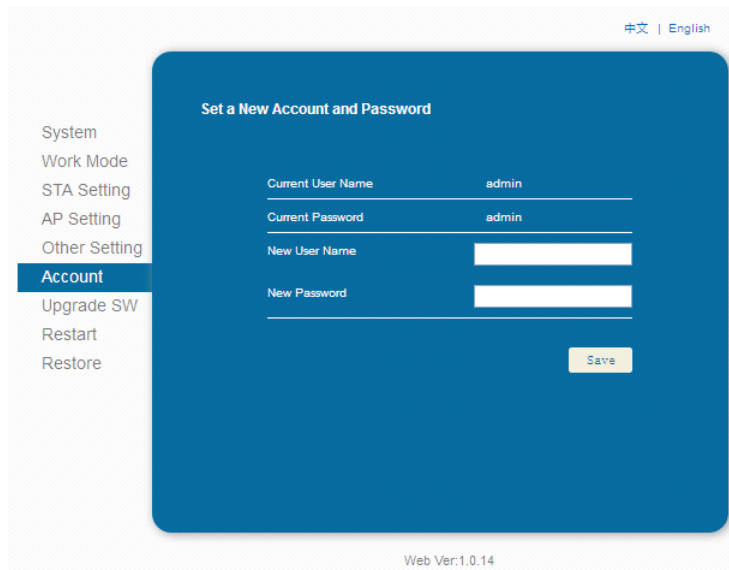

Figure 43 Account Page

### 5.1.9 Upgrade Software Page

User can upgrade new software (firmware) version through Wi-Fi.



Figure 44 Upgrade SW page

### 5.1.10 Restart Page

Most of the setting and configuration can only effective after system restart. User shall restart after finish all setting.

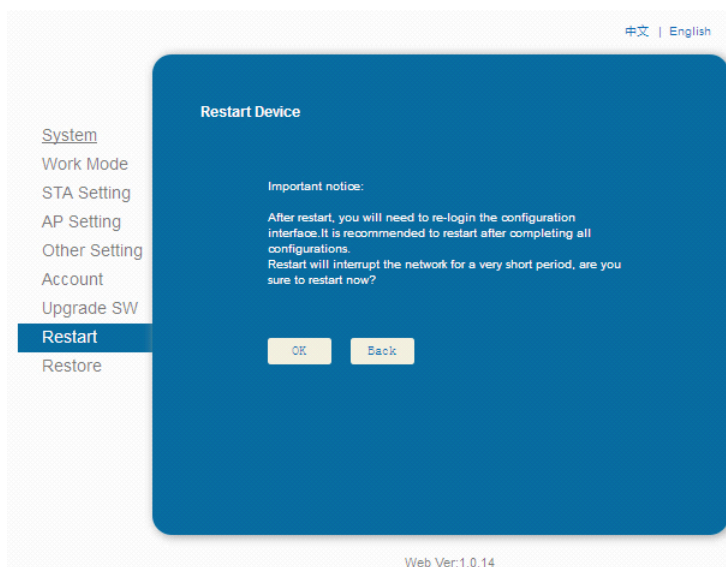

Figure 45 Restart Page

### 5.1.11 Restore Page

After module restore factory default setting, all user configuration profile will lose. User can access <http://10.10.100.254> to set again, and user name and password is "admin". USR-WIFI232-G2/H will restore to AP mode for factory default setting.

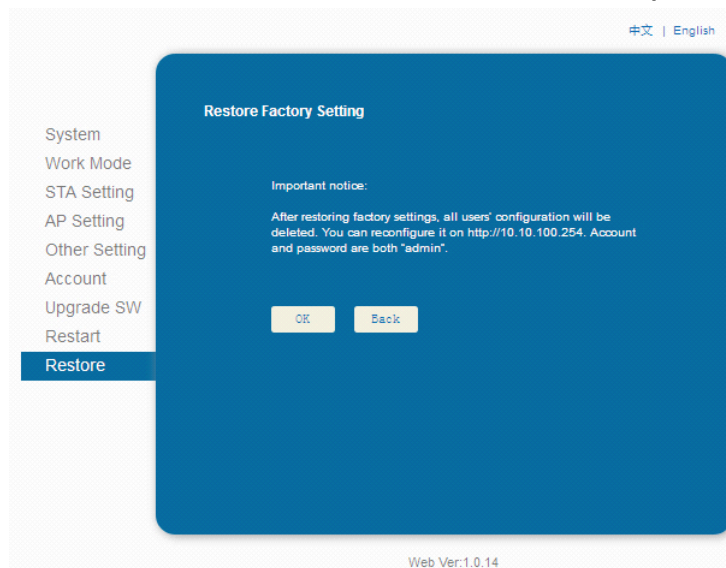

Figure 46 Restore Page

## 5.2 AT command

AT command means the command by which user can query and set the parameters to module in command mode through the serial port. The following will explain in detail about the method of switching module work mode and the use format of AT commands.



When USR-WIFI232-S/T/G2/H power up, it will default works as throughput mode, then user can switch to command mode by serial port command. USR-WIFI232-S/T/G2 UART default parameters setting as below figure:

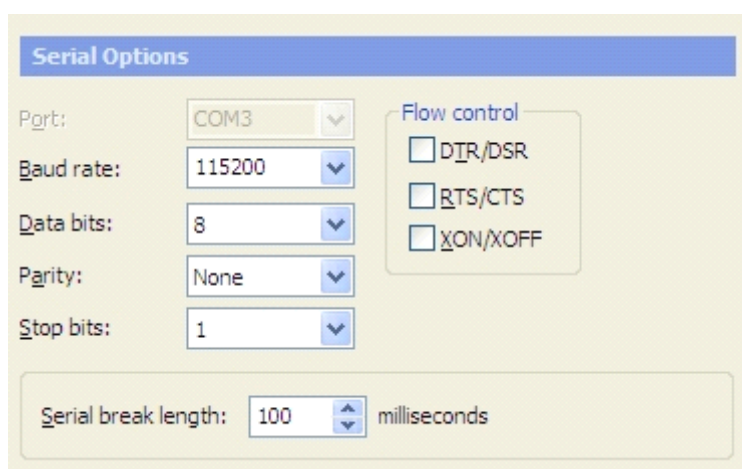

Figure 47 USR-WIFI232-S/T/G2/H default parameters

In command mode, user can setting the module through AT command,

**Note:**

AT command debugging tools recommended SecureCRT App software tools or USR-TCP232-test tool. Users can be obtained the tool from USR's Web site.The following demonstration uses SecureCRT tools.

### 5.2.1 Switch to Command Mode

Two steps to finish switching from throughput mode to command mode:

- UART input “+++”, after module receive “+++”, and feedback “a” as confirmation.
- ART input “a”, after module receive “a” and feedback “+ok” to go into AT+instruction set configuration mode.

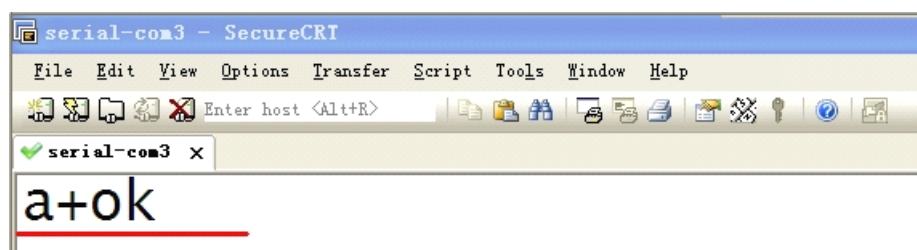

Figure 48 Switch to Command Mode

**Note:**

1. When user input “+++” (No “Enter” key required), the UART port will display feedback information “a”, and not display input information “+++” as above UART display.

2. Any other input or wrong step to UART port will cause the module still works as original mode (throughput mode)

3. “+++” and “a” should be input in a certain period of time to make the module switch to configuration mode. Like the following sequence.

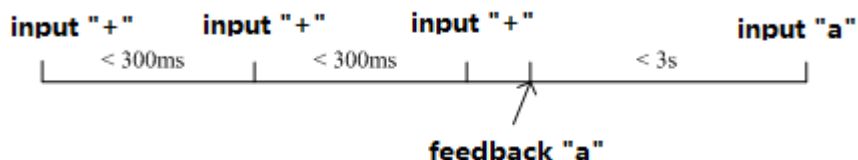

Figure 49 '+'+'、'a' Time Requirements

Switching command mode to throughput mode need to use AT+ENTM command, input 'AT+ENTM' in command mode ends with the enter key, you can switch to passthrough mode.

### Note :

Here work mode switch is temporary, module still work in the default work mode after the restart, if need to change the module default work mode, please refer to the AT+TMODE command.

## 5.2.2 AT command Overview

User can input AT+Instruction through hyper terminal or other serial debug terminal, also can program the AT+Instruction to script. User can also input "AT+H" to list all AT+Instruction and description to start.

```

AT+H
+ok

AT+: NONE command, reply "+ok".
AT+ASWD: Set/Query WiFi configuration code.
AT+E: Echo ON/off, to turn on/off command line echo function.
AT+ENTM: Goto Through Mode.
AT+NETP: Set/Get the Net Protocol Parameters.
AT+UART: Set/Get the UART Parameters.
AT+UARTF: Enable/disable UART AutoFrame function.
AT+UARTFT: Set/Get time of UART AutoFrame.
AT+UARTFL: Set/Get frame length of UART AutoFrame.
AT+UARTTE: Set/Query UART free-frame triggerf time between two byte.
AT+PING: General PING command.
AT+WAP: Set/Get the AP parameters.
AT+WKEY: Set/Get the Security Parameters of WIFI AP Mode.
AT+WMODE: Set/Get the WIFI Operation Mode (AP or STA).
AT+WSKEY: Set/Get the Security Parameters of WIFI STA Mode.
AT+WSSID: Set/Get the AP's SSID of WIFI STA Mode.
AT+WSLK: Get Link Status of the Module (Only for STA Mode).
AT+WSQLQ: Get Link Quality of the Module (Only for STA Mode).
AT+WSCAN: Get The AP site Survey (only for STA Mode).
AT+WEBU: Set/Get the Login Parameters of WEB page.
AT+TCPK: Get The state of TCP link.
AT+TCPTO: Set/Get TCP time out.
AT+TCPDIS: Connect/Dis-connect the TCP client link
AT+RCV: Recv data from UART
AT+SEND: Send data to UART
AT+WANN: Set/Get The WAN setting if in STA mode.
AT+LANN: Set/Get The LAN setting if in ADHOC mode.
AT+RELD: Reload the default setting and reboot.
AT+RLDEN: Put on/off the GPIO12.
AT+Z: Reset the Module.
AT+MID: Get The Module ID.
AT+VER: Get application version.
AT+H: Help.
    
```

Figure 50 "AT+H"command

AT command is based on the instruction of ASCII command style, the description of syntax format as follow.

➤ **Format Description**

< >: Means the parts must be included

[ ]: Means the optional part

➤ **Command Message**

**AT+<CMD>[op][para-1,para-2,para-3,para-4...]<CR>**

AT+: Prefix of command message;

CMD: Command string;

[op]: Symbol of command operator;

◆ "=" : The command requires parameters input;

◆ "NULL": Query the current command parameters setting;

[para-n]: Parameters input for setting if required;

<CR>: "Enter" Key, it's 0x0a or 0x0d in ASCII;

**Notes:**

When input AT+Instruction, "AT+<CMD>" character will display capital letter automatic and other parts will not change as you input.

➤ **Response Message**

**+<RSP>[op] [para-1,para-2,para-3,para-4...]<CR><LF><CR><LF>**

+: Prefix of response message;

RSP: Response string;

◆ "ok" : Success

◆ "ERR: Failure

[op]: =

[para-n]: Parameters if query command or Error code when error happened;

<CR>: ASCII 0x0d;

<LF>: ASCII 0x0a;

➤ **Error Code**

Table 18 Error Code Description

Error Code	Description
-1	Invalid Command Format
-2	Invalid Command
-3	Invalid Operation Symbol
-4	Invalid Parameter
-5	Operation Not Permitted

## 5.2.3 AT command introduction

Table 19 AT command list

NO	Command	Description
<b>Manage Command</b>		
1	E	Open/Close show back function
2	WMODE	Set/Query Wi-Fi work mode (AP/STA/APSTA)
3	ENTM	Set module into transparent transition mode
4	TMODE	Set/Query module data transfer mode

5	MID	Query module ID information
6	RELD	Restore to factory default setting
7	Z	Re-start module
8	H	Help
<b>Configure Parameters Command</b>		
9	CFGTF	Copy User Parameters to Factory Default Parameters
<b>UART Command</b>		
10	UART	Set/Query serial port parameters
11	UARTF	Open/Close UART auto-frame function
12	UARTFT	Set/Query UART auto-frame trigger time
13	UARTFL	Set/Query UART auto-frame trigger length
14	UARTTE	Set/Query UART free-frame trigger time between two bytes
<b>Network Command</b>		
15	PING	Network "Ping" command
<b>SOCK A Command</b>		
16	SEND	Send Data to Sock A at Command Mode
17	RECV	Receive Data from Sock A at Command Mode
18	NETP	Set/Query Sock A network protocol parameters
19	MAXSK	Set/Query Sock A TCP Client connection number
20	TCPLK	Query if Sock A TCP link already build-up
21	TCPTO	Set/Query Sock A TCP timeout
22	TCPDIS	Open/Close Sock A TCP link
<b>SOCK B Command</b>		
23	SOCKB	Set/Query Sock B network protocol parameters
24	TCPDISB	Open/Close Sock B TCP link
25	TCPTOB	Set/Query Sock B TCP timeout
26	TCPLKB	Query if Sock B TCP link already build-up
27	SNDB	Send data to Sock B in Command Mode
28	RCVB	Receive data from Sock B in Command Mode
<b>WiFi STA Command</b>		
29	WSSID	Set/Query associated AP SSID parameters
30	WSKEY	Set/Query STA security parameters
31	WANN	Set/Query STA's network parameters
32	WSMAC	Set/Query STA's MAC address
33	WSLK	Query STA Wi-Fi link status
34	WSLQ	Query STA Wi-Fi signal strength
35	WSCAN	Scan AP
36	WSDNS	Set/Query STA's Static DNS server address
<b>WiFi AP Command</b>		
37	LANN	Set/Query AP's network parameters
38	WAP	Set/Query AP Wi-Fi parameters
39	WAKEY	Set/Query AP security parameters

40	WAMAC	Set/Query AP MAC address
41	WADHCP	Set/Query AP DHCP Server status
42	WALK	Query MAC address of STA device connecting to module AP
43	WALKIND	Enable/Disable indication of connection status.
<b>Web Command</b>		
44	PLANG	Set/Query Webpage Language Option
45	WEBU	Set/Query Webpage User name and Code
<b>Power Manage Command</b>		
46	MSLP	Set/Query deep sleep/standby mode parameters (reserved)
<b>NTP Time Command</b>		
47	NTPRF	Set/Query time calibration interval
48	NTPEN	Enable/Disable time calibration function
49	NTPTM	Query time
<b>Other Command</b>		
50	WRMID	Set module ID
51	ASWD	Set/Query search keywords in LAN
52	MDCH	Set Wi-Fi Auto Switch Function
53	TXPWR	Set/Query Wi-Fi Transmit Power
54	WPS	Start WPS function
55	WPSBTNEN	Enable/Disable GPIO 15 WPS function
56	SMTLK	Start Smartlink function
57	LPTIO	Enable/Disable nReady, nLink function

### 1) AT+E

- Function: Open/Close show back function;
- Format:

**AT+E<CR>**

**+ok<CR>< LF ><CR>< LF >**

When module firstly switch from throughput mode to command mode, show back status is open, input "AT+E" to close show back function, input"AT+E" again to open show back function.

### 2) AT+WMODE

- Function: Set/Query Wi-Fi work mode (AP/STA/APSTA). Setting is valid after reset;
- Format:

- ◆ Query Operation

**AT+WMODE<CR>**

**+ok=<mode><CR>< LF ><CR>< LF >**

- ◆ Set Operation

**AT+ WMODE=<mode><CR>**

**+ok<CR>< LF ><CR>< LF >**

- Parameters:

- ◆ Mode: WI-FI work mode

- AP

- STA
- APSTA

### 3) AT+ENTM

- Function: Set module into throughput mode;
- Format:

**AT+ENTM<CR>**

**+ok<CR>< LF ><CR>< LF >**

After operate this command,module switch from command mode to throughput mode.

### 4) AT+TMODE

- Function: Set/Query module data transfer mode. Setting is valid after reset.
- Format:

- ◆ Query Operation:

**AT+TMODE<CR>**

**+ok=<tmode><CR>< LF ><CR>< LF >**

- ◆ Set Operation:

**AT+TMODE=<tmode><CR>**

**+ok<CR>< LF ><CR>< LF >**

- Parameters:

- ◆ TMODE: module work mode,include:

- Throughput: throughput mode
- Cmd: command mode
- Pwm: PWM/GPIO mode

### 5) AT+MID

- Function: Query module ID information
- Format:

**AT+MID<CR>**

**+ok=<module\_id><CR>< LF ><CR>< LF >**

- Parameters:

- ◆ module\_id: module ID information

- USR-WIFI232-S/T/G2

Notes: User can set this parameter through AT+WRMID.

### 6) AT+RELD

- Function: module restore to factory default setting.
- Format:

**AT+ RELD<CR>**

**+ok=rebooting...<CR>< LF ><CR>< LF >**

When operate this command, module will restore to factory default setting and reboot.

### 7) AT+Z

- Function: Re-start module;
- Format:

**AT+ Z<CR>**

### 8) AT+H

- Function: Help;

- Format:  
**AT+H<CR>**  
**+ok=<command help><CR>< LF ><CR>< LF >**
- Parameters:
  - ◆ command help: command introduction;

#### 9) AT+CFGTF

- Function: Copy User Parameters to Factory Default Parameters;
- Format:
  - ◆ Query Operation  
**AT+CFGTF<CR>**  
**+ok=<status><CR>< LF ><CR>< LF >**
  - ◆ Parameters:
    - ◆ Status: feedback operation status;

#### 10) AT+UART

- Function: Set/Query serial port parameters. Setting is valid after reset;
- Format:
  - ◆ Query Operation:  
**AT+UART<CR>**  
**+ok=<baudrate,data\_bits,stop\_bit,parity,flowctrl><CR><LF>**
  - ◆ Set Operation:  
**AT+UART=<baudrate,data\_bits,stop\_bit,parity,flowctrl><CR>**  
**+ok<CR>< LF ><CR>< LF >**
  - ◆ Parameters:
    - ◆ Baudrate:
      - 600,1200,1800,2400,4800,9600,19200,38400,57600,115200,230400,380400,460800
    - ◆ data\_bits:
      - 8
    - ◆ stop\_bits:
      - 1,2
    - ◆ Parity:
      - NONE
      - EVEN
      - ODD
    - ◆ Flowctrl: (CTS/RTS)
      - NFC: No hardware flow control
      - FC: hardware flow control(USR-WIFI232-T don't have hardware flow control).

#### 11) AT+UARTF

- Function: Open/Close UART auto-frame function;
- Format:
  - ◆ Query Operation:  
**AT+ UARTF<CR>**  
**+ok=<para><CR>< LF ><CR>< LF >**
  - ◆ Set Operation:

**AT+ UARTF=<para ><CR>**  
**+ok<CR>< LF ><CR>< LF >**

- Parameters:
  - ◆ Para:
    - disable - Close auto-frame function;
    - enable - Open auto-frame function;

## 12) AT+UARTFT

- Function: Set/Query UART auto-frame trigger time;
- Format:
  - ◆ Query Operation:  
**AT+ UARTFT<CR>**  
**+ok=<time><CR>< LF ><CR>< LF >**
  - ◆ Set Operation:  
**AT+ UARTFT=<time ><CR>**  
**+ok<CR>< LF ><CR>< LF >**
- Parameters:
  - ◆ Time: Range 250 ~10000; Unit: ms. Auto-frame trigger time.

## 13) AT+UARTFL

- Function: Set/Query UART auto-frame trigger length;
- Format:
  - ◆ Query Operation:  
**AT+ UARTFL<CR>**  
**+ok=<len><CR>< LF ><CR>< LF >**
  - ◆ Set Operation:  
**AT+ UARTFL=<len ><CR>**  
**+ok<CR>< LF ><CR>< LF >**
- Parameters:
  - ◆ Len: Range 8 ~1000; Unit: Byte. Auto-frame trigger length;

## 14) AT+UARTTE

- Function: Set/Query UART free-frame trigger time between two bytes;
- Format:
  - ◆ Query Operation:  
**AT+ UARTTE<CR>**  
**+ok=<mode><CR>< LF ><CR>< LF >**
  - ◆ Set Operation:  
**AT+ UARTTE=<mode ><CR>**  
**+ok<CR>< LF ><CR>< LF >**
- Parameters:
  - ◆ Mode:
    - fast: free-frame trigger time between two bytes is 200ms;
    - normal: free-frame trigger time between two bytes is 250ms;

## 15) AT+PING

- Function: Network "Ping" command;
- Format:
  - ◆ Set Operation:



**AT+PING=<IP\_address><CR>**  
**+ok=<fb><CR><LF><CR><LF>**

- Parameters:
  - ◆ Fb: feedback result
    - Success
    - Timeout
    - Unknown host

#### 16) AT+SEND

- Function: Send Data to SOCKA at Command Mode.
- Format:

**AT+SEND=<data\_lenth><CR>**  
**+ok<CR><LF><CR><LF>**

- Parameters:
    - ◆ data\_lenth: Lenth of send data. Range: 0~1000 Byte
- The UART port will feedback a '>' and then wait 3 seconds for input after this command is sent OK. The data received from UART port is sent to SOCKA. If the interval of two bytes is more than 10ms, the data will be sent instantly.

#### 17) AT+RECV

- Function: Receive Data from SOCKA at Command Mode;
- Format:

**AT+RECV=<data\_lenth><CR>**  
**+ok=< data\_lenth, data\_content><CR><LF><CR><LF>**

- Parameters:
    - ◆ data\_lenth: Lenth of receive data. Range: 0~1000 Byte;
    - ◆ data\_content: contents of receive data.
- If not receive any data in 3 second, then feedback +ok=0.

#### 18) AT+NETP

- Function: Set/Query SOCKA network protocol parameters, Setting is valid after reset.
- Format:

- ◆ Query Operation:  
**AT+NETP<CR>**  
**+ok=<protocol,CS,port,IP><CR><LF><CR><LF>**
- ◆ Set Operation:  
**AT+NETP=<protocol,CS,port,IP><CR>**  
**+ok<CR><LF><CR><LF>**

- Parameters:
  - ◆ Protocol:
    - TCP
    - UDP
  - ◆ CS:
    - SERVER
    - CLIENT
  - ◆ Port: protocol port ID: Decimal digit and less than 65535.
  - ◆ IP: Server's IP address when module set as client.

If set as UDP SERVER, the module will save the IP address and port of the latest UDP packet received. The data will be sent to the saved IP address and port. If the module hasn't saved any IP address and port when power up. The data will be sent to the IP address and port which is set by this command.

If set as UDP CLIENT, the data will always be sent to the IP address and port set by this command.

### 19) AT+MAXSK

- Function: Set / Query the maximum connection number of TCP Client when SOCKA work in TCP Server.
- Format:
  - ◆ Query Operation:  
**AT+MAXSK<CR>**  
**+ok=<num><CR><LF><CR><LF>**
  - ◆ Set Operation:  
**AT+MAXSK=<num><CR>**  
**+ok<CR><LF><CR><LF>**
- Parameters:
  - ◆ num: TCP Client connection number. Range: 1~5.  
5 is the default value.it means when SOCKA work in TCP server, it accepts max 5 TCP client connect to it.

### 20) AT+TCPLK

- Function: Query SOCKA connection status;
- Format:  
**AT+ TCPLK<CR>**  
**+ok=<sta><CR><LF><CR><LF>**
- Parameters:
  - ◆ sta: SOCKA connection status;
    - on: TCP connected;
    - off: TCP disconnected;

### 21) AT+TCPTO

- Function: Set/Query SOCKA TCP timeout time;
- Format:
  - ◆ Query Operation:  
**AT+ TCPTO<CR>**  
**+ok=<time><CR><LF><CR><LF>**
  - ◆ Set Operation:  
**AT+ TCPTO=<time ><CR>**  
**+ok<CR><LF><CR><LF>**
- Parameters:
  - ◆ Time: TCP timeout time.
    - <= 600: 600s
    - >=0: 0 (0 means no timeout);
    - Default: 300s

SOCKA begin to count time when TCP channel don't receive any data, clear time counter when TCP channel receive any data. If the time counter reaches the TCPTO

time, the tcp channel will be break. If SOCKA work in TCP Client, it will connect the TCP server instantly, and when the module work in TCP Server, the TCP client device should make the connection itself.

## 22) AT+TCPDIS

- Function: Open/Close SOCKA TCP link;
- Format:
  - ◆ Query Operation:  
**AT+TCPDIS<CR>**  
**+ok=<sta><CR><LF><CR><LF>**
  - ◆ Set Operation:  
**AT+TCPDIS=<on/off><CR>**  
**+ok<CR><LF><CR><LF>**
- Parameters:
  - On:TCP link close
  - Off: TCP link on

When query Operation, sta: Feedback if SOCKA TCP Client is link.

When Set Operation, "off" means close TCP link. After finish this command, module disconnect TCP link and not connect again. "On" means open TCP link. After finish this command, module re-connect TCP server right away.

## 23) AT+SOCKB

- Function: Set/Query SOCKB network protocol parameters. Setting is valid after reset.
- Format:
  - ◆ Query Operation:  
**AT+SOCKB<CR>**  
**+ok=<protocol,port,IP><CR><LF><CR><LF>**
  - ◆ Set Operation:  
**AT+SOCKB=<protocol,port,IP><CR>**  
**+ok<CR><LF><CR><LF>**
- Parameters:
  - ◆ Protocol:
    - TCP: Only for TCP Client;
    - UDP: UDP Client
    - UDPS: UDP Server
  - ◆ Port: Protocol Port in decimal, less than 65535;
  - ◆ IP: Destination IP address, domain name is support;

If set as UDP SERVER, the module will save the IP address and port of the latest UDP packet received. The data will be sent to the saved IP address and port. If the module hasn't saved any IP address and port when power up. The data will be sent to the IP address and port which is set by this command.

If set as UDP CLIENT, the data will always be sent to the IP address and port set by this command.

## 24) AT+TCPDISB

- Function: Open/Close SOCKB TCP link;
- Format:
  - ◆ Query Operation:

**AT+TCPDISB<CR>****+ok=<sta><CR>< LF ><CR>< LF >**

- ◆ Set Operation:

**AT+ TCPDISB =<on/off><CR>****+ok<CR>< LF ><CR>< LF >**

- Parameters:

When query Operation, sta: Feedback if SOCKB TCP Client is link.

When Set Operation, "off" means close TCP link. After finish this command, module disconnect TCP link and not connect again. "On" means open TCP link. After finish this command, module re-connect TCP server right away.

## 25) AT+TCPTOB

- Function: Set/Query Operation SOCKB timeout time;

- Format:

- ◆ Query Operation:

**AT+ TCPTOB<CR>****+ok=<time><CR>< LF ><CR>< LF >**

- ◆ Set Operation:

**AT+ TCPTOB=<time ><CR>****+ok<CR>< LF ><CR>< LF >**

- Parameters:

- ◆ Time: TCP timeout time.

- <= 600: 600s
- >=0: 0 (0 means no timeout);
- Default: 300s

SOCKB begin to count time when TCP channel don't receive any data, clear time counter when TCP channel receive any data. If the time counter reaches the TCPTO time, the tcp channel will be break. If SOCKB work in TCP Client, it will connect the TCP server instantly.

## 26) AT+TCPLKB

- Function: Query SOCKB connection status:

- Format:

**AT+ TCPLKB<CR>****+ok=<sta><CR>< LF ><CR>< LF >**

- Parameters:

- ◆ sta: SOCKB connection status

- on: TCP connected
- off: TCP disconnected

## 27) AT+SNDB

- Function: Send Data to SOCKB at Command Mode.

- Format:

**AT+SNDB=<data\_lenth ><CR>****+ok<CR>< LF ><CR>< LF >**

- Parameters:

- ◆ data\_lenth: Lenth of send data. Range: 0~1000 Byte;

The UART port will feedback a '>' and then wait 3 seconds for input after this command is sent OK. The data received from UART port is sent to SOCKA. If the interval of two bytes is more than 10ms, the data will be sent instantly.

### 28) AT+RCVB

➤ Function: Receive Data from SOCKA at Command Mode;

➤ Format:

**AT+RCVB=<data\_lenth><CR>**

**+ok=< data\_lenth, data\_content><CR>< LF ><CR>< LF >**

➤ Parameters:

◆ data\_lenth: Lenth of receive data. Range: 0~1000 Byte;

◆ data\_content: contents of receive data.

If not receive any data in 3 second, then feedback +ok=0

### 29) AT+WSSSID

➤ Function: Set/Query Wi-Fi associated AP SSID parameters. Setting is valid after reset.

➤ Format:

◆ Query Operation:

**AT+WSSSID<CR>**

**+ok=<ap's ssid><CR>< LF ><CR>< LF >**

◆ Set Operation:

**AT+ WSSSID=<ap's ssid ><CR>**

**+ok<CR>< LF ><CR>< LF >**

➤ Parameters:

◆ ap's ssid: AP's SSID (Within 32 character);

### 30) AT+WSKEY

➤ Function: Set/Query STA security parameters. Setting is valid after reset.

➤ Format:

◆ Query Operation:

**AT+WSKEY<CR>**

**+ok=<auth,encry,key><CR>< LF ><CR>< LF >**

◆ Set Operation:

**AT+ WSKEY=< auth,encry,key><CR>**

**+ok<CR>< LF ><CR>< LF >**

➤ Parameters:

◆ Auth: Authentication mode

- OPEN
- SHARED
- WPAPSK
- WPA2PSK

◆ Encry: Encryption algorithm

- NONE: When "auth=OPEN", effective
- WEP-H: When "auth=OPEN" or "SHARED", effective, HEX format
- WEP-A: When "auth=OPEN" or "SHARED", effective, ASCII format
- TKIP: When "auth= WPAPSK" "WPA2PSK", effective
- AES: When "auth= WPAPSK" "WPA2PSK", effective

- ◆ Key: password, when encry = WEP-H, the password is the hexadecimal number, must be 10 byte or 26 byte; When encry = WEP-A, the password is the ASCII code, must be 5 byte or 13 byte; other ASCII code, shall less than 64 byte and greater than 8 byte.

### 31) AT+WANN

- Function: Set/Query STA network setting. Setting is valid after reset.
- Format:
  - ◆ Query Operation:  
**AT+WANN<CR>**  
**+ok=<mode,address,mask,gateway><CR>< LF ><CR>< LF >**
  - ◆ Set Operation:  
**AT+ WANN=< mode,address,mask,gateway ><CR>**  
**+ok<CR>< LF ><CR>< LF >**
- Parameters:
  - ◆ Mode:STA's IP network setting
    - Static: Static IP
    - DHCP: Dynamic IP
  - ◆ Address: STA IP address;
  - ◆ mask: STA subnet mask;
  - ◆ gateway: STA gateway address;

### 32) AT+WSMAC

- Function: Set/Query STA MAC address parameters. Setting is valid after reset.
- Format:
  - ◆ Query Operation:  
**AT+WSMAC<CR>**  
**+ok=<mac\_address><CR>< LF ><CR>< LF >**
  - ◆ Set Operation:  
**AT+ WSMAC=<code,mac\_address><CR>**  
**+ok<CR>< LF ><CR>< LF >**
- Parameters:
  - ◆ Code: security code
    - 8888 (default value)
  - ◆ mac\_address: STA MAC address, such as D8B0CFFF1234

### 33) AT+WSLK

- Function: Query STA WiFi link status;
- Format:
  - ◆ Query Operation:  
**AT+ WSLK<CR>**  
**+ok=<ret><CR>< LF ><CR>< LF >**
- Parameters:
  - ◆ ret
    - Disconnected, if no WiFi connection
    - "AP' SSID (AP's MAC" ) , if WiFi connection available;

### 34) AT+WSLQ

- Function: Query STA WiFi signal strength;

- Format:
  - ◆ Query Operation:  
**AT+ WSLQ<CR>**  
**+ok=<ret><CR>< LF ><CR>< LF >**
- Parameters:
  - ◆ ret
    - Disconnected, if no WiFi connection
    - 'AP's WiFi signal strength , if WiFi connection available;

### 35) AT+WSCAN

- Function: Scan AP;
- Format:
  - ◆ Query Operation:  
**AT+ WSCAN<CR>**  
**+ok=<ap\_site><CR>< LF ><CR>< LF >**
- Query Operation:
  - ◆ ap\_site: AP site has been searched;

### 36) AT+WSDNS

- Function: Set/Query STA static DNS server address;
- Format:
  - ◆ Query Operation:  
**AT+WSDNS<CR>**  
**+ok=<address><CR>< LF ><CR>< LF >**
  - ◆ Set Operation:  
**AT+ WSDNS =<address><CR>**  
**+ok<CR>< LF ><CR>< LF >**
- Parameters:
  - ◆ address: STA's DNS server address; Effective right away.

### 37) AT+LANN

- Function: Set/Query AP's network parameters. Setting is valid after reset.
- Format:
  - ◆ Query Operation:  
**AT+LANN<CR>**  
**+ok=<ipaddress,mask><CR>< LF ><CR>< LF >**
  - ◆ Set Operation:  
**AT+ LANN=< ipaddress,mask><CR>**  
**+ok<CR>< LF ><CR>< LF >**
- Parameters:
  - ◆ Ipaddress:AP's IP address;
  - ◆ Mask: AP's net mask;

### 38) AT+WAP

- Function: Set/Query AP Wi-Fi parameters. Setting is valid after reset.
- Format:
  - ◆ Query Operation:  
**AT+WAP<CR>**  
**+ok=< wifi\_mode,ssid,channel ><CR>< LF ><CR>< LF >**

- ◆ Set Operation:  
**AT+ WAP =<wifi\_mode,ssid,channel ><CR>**  
**+ok<CR>< LF ><CR>< LF >**

➤ Parameters:

- ◆ wifi\_mode: Wi-Fi mode, include:
  - 11B
  - 11BG
  - 11BGN (Default Value)
- ◆ Ssid: SSID at AP mode
- ◆ channel: Wi-Fi channel selection: AUTO or CH1~CH11; (Default CH1)

### 39) AT+WAKEY

- Function: Set/Query AP Wi-Fi security parameters. Setting is valid after reset.

➤ Format:

- ◆ Query Operation:  
**AT+WAKEY<CR>**  
**+ok=<auth,encry,key><CR>< LF ><CR>< LF >**
- ◆ Set Operation:  
**AT+ WAKEY=< auth,encry,key><CR>**  
**+ok<CR>< LF ><CR>< LF >**

➤ Parameters:

- ◆ Auth: include
  - OPEN
  - WPA2PSK
- ◆ Encry: include
  - NONE: When "auth=OPEN" available;
  - AES: When "auth=WPA2PSK" available;
- ◆ Key: security code, ASCII code, smaller than 64bit and bigger than 8 bit;

### 40) AT+WAMAC

- Function: Query AP MAC address parameters;

➤ Format:

- ◆ Query Operation:  
**AT+WAMAC<CR>**  
**+ok=<mac\_address><CR>< LF ><CR>< LF >**

➤ Parameters:

- ◆ mac\_address: AP's MAC address;

Note: Module AP mode's MAC address is related to STA mode's MAC address. If user need changeto others, please contact with USR technical people.

### 41) AT+WADHCP

- Function: Set/Query AP DHCP server status;

➤ Format:

- ◆ Query Operation:  
**AT+WADHCP<CR>**  
**+ok=<status><CR>< LF ><CR>< LF >**
- ◆ Set Operation:  
**AT+ WADHCP=<status><CR>**



**+ok<CR>< LF ><CR>< LF >**

- Parameters:
  - ◆ status: AP's DHCP server function status;
    - on: DHCP Server Open;
    - off: DHCP Server Close;

## 42) AT+WALK

- Function: Query MAC address of STA device connecting to module AP;
- Format:
  - ◆ Query Operation:  
**AT+WALK<CR>**  
**+ok=<status><CR><LF><CR><LF>**
- Parameters:
  - ◆ status: MAC address of STA device connecting to module AP.
    - No Connection:No STA device connecting to module AP;

## 43) AT+WALKIND

- Function: Enable/Disable indication of module AP connection status.
- Format:
  - ◆ Query Operation:  
**AT+WALKIND<CR>**  
**+ok=<status><CR><LF><CR><LF>**
  - ◆ Set Operation:  
**AT+WALKIND=<status><CR>**  
**+ok<CR><LF><CR><LF>**
- Parameters:
  - ◆ status: indication of module AP connection status.
    - on: Enable nLink indication function. When STA device connecting to module AP, nLink output Low, otherwise output High.
    - off: Disable nLink indication function.

## 44) AT+PLANG

- Function: Set/Query webpage language option;
- Format:
  - ◆ Query Operation  
**AT+PLANG<CR>**  
**+ok=<language><CR>< LF ><CR>< LF >**
  - ◆ Set Operation:  
**AT+PLANG =<language><CR>**  
**+ok<CR>< LF ><CR>< LF >**
- Parameters:
  - ◆ Language: webpage's language
    - CN:Chinese Version (Default);
    - EN: English Version;

## 45) AT+WEBU

- Function: Set/ Query webpage user name and password;
- Format:
  - ◆ Query Operation:

**AT+WEBU<CR>****+ok=<username,password><CR>< LF ><CR>< LF >**

- ◆ Set Operation:

**AT+WEBU =<username, password><CR>****+ok<CR>< LF ><CR>< LF >**

- Parameters:

- ◆ Username: User Name, within 15 characters, not support empty.
- ◆ Password: password, within 15 characters, support empty.

## 46) AT+MSLP(Reserved)

- Function: Set/Query deep sleep/standby mode parameters;
- Format:

- ◆ Query Operation:

**AT+ MSLP<CR>****+ok=<ret><CR>< LF ><CR>< LF >**

- ◆ Set Operation:

**AT+ MSLP=<mode><CR>< LF ><CR>< LF >**

- Parameters:

- ◆ ret:

- normal: normal mode (100ms interval)

- ◆ mode:

- normal: normal mode (100ms interval)
- standby: WiFi shut down mode.

## 47) AT+NTPRF

- Function: Set /Query time calibration interval;
- Format:

- ◆ Query Operation:

**AT+ NTPRF<CR>****+ok=<num><CR>< LF ><CR>< LF >**

- ◆ Set Operation:

**AT+ NTPRF=<num><CR>****+ok<CR>< LF ><CR>< LF >**

- Parameters:

- ◆ Num: time calibration interval, range:0~720, default:30 minutes, 10 minutes for each step, set 0 means no time calibration automatically.

## 48) AT+NTPEN

- Function: Enable/Disable time calibration function.
- Format:

- ◆ Query Operation:

**AT+ NTPEN<CR>****+ok=<status><CR>< LF ><CR>< LF >**

- ◆ Set Operation:

**AT+ NTPEN=<status><CR>****+ok<CR>< LF ><CR>< LF >**

- Parameters:

- ◆ Status: status of time calibration

- On: Enable time calibration;
- Off: Disable time calibration

#### 49) AT+NTPTM

- Function: Query network time
- Format:
  - ◆ Query Operation:  
**AT+ NTPTM<CR>**  
**+ok=<time><CR>< LF ><CR>< LF >**
- Parameters:
  - ◆ Time: network time, for example: 2013-10-9 16:10:42 Wed, if it shows Not Available means that the time calibration function is not enabled or the module doesn't connect to the internet.

#### 50) AT+WRMID

- Function: Set module ID;
- Format:
  - ◆ Set Operation:  
**AT+ WRMID =<wrmid><CR>< LF ><CR>< LF >**
- Parameters:
  - ◆ wrmid: set module's ID (within 20 characters).

#### 51) AT+ASWD

- Function: Set/Query WiFi Configuration Password;
- Format:
  - ◆ Query Operation:  
**AT+ ASWD <CR>**  
**+ok=<aswd><CR>< LF ><CR>< LF >**
  - ◆ Set Operation:  
**AT+ASWD =<aswd><CR>< LF ><CR>< LF >**
- Parameters:
  - ◆ aswd: WiFi Configuration Password (within 20 characters).

#### 52) AT+MDCH

- Function: Set Wi-Fi Auto Switch Function
- Format:
  - ◆ Query Operation:  
**AT+ MDCH <CR>**  
**+ok=<mode><CR>< LF ><CR>< LF >**
  - ◆ Set Operation:  
**AT+MDCH=<mode><CR>< LF ><CR>< LF >**
- Parameters:
  - ◆ mode: Wi-Fi Auto Switch Mode.
    - Off: Disable Wi-Fi auto switch.
    - On: Enable Wi-Fi auto switch. When the module(STA mode) fail to connect to router, it will switch to AP mode itself in one minute.
    - Auto: Enable Wi-Fi auto detect function. The module will reset itself when encounter any abnormal. The default time interval is 10 minutes. **(default mode).**

- 3-120:unit: minute. Set the time interval to reset itself when abnormal.

### 53) AT+TXPWR

- Function: Set/Query Wi-Fi Transmit Power;  
Real Transmit Power=Default Transmit Power(16dBm) – [Setting Value] \* 0.5dBm
- Format:
  - ◆ Query Operation:  
**AT+TXPWR <CR>**  
**+ok=<num><CR><LF><CR><LF>**
  - ◆ Set Operation:  
**AT+TXPWR=<num><CR>**  
**+ok<CR><LF><CR><LF>**
- Parameters:
  - ◆ Num: [Setting Value]. The default is 0, it can be sent from 0 ~ 24. If set to 24, the module transmit power will be at a minimum of 4dBm. Reboot to make this setting change valid. It will not restore to default if reload the module.

### 54) AT+WPS

- Function: Start WPS function
- Format:
  - ◆ Query Operation:  
**AT+WPS<CR>**  
**+ok=<status><CR><LF><CR><LF>**
- Parameters:
  - ◆ status: Start WPS Scan function. The module will reboot and work in STA mode connecting to specific router when WPS communication is OK.
    - WPS Scan Failed: WPS communication is failed.

#### Note:

The router WPS function must be open first then enable module WPS Scan function. The module will quit WPS scan status if there is no WPS router in 5 seconds.

### 55) AT+WPSBTNEN

- Function: Enable/Disable WPS pin function.
- Format:
  - ◆ Query Operation:  
**AT+WPSBTNEN<CR>**  
**+ok=<status><CR><LF><CR><LF>**
- Parameters:
  - ◆ status;
    - on: Enable WPS pin function
    - off: Enable WPS pin function

### 56) AT+SMTLK

- Function: Start Smartlink function.
- Format:
  - ◆ Query Operation:  
**AT+SMTLK<CR>**

Smartlink function is used to quickly configure the router's SSID and password to module. When start Smartlink function module's led lights flashing wait APP push configuration information.

### 57) AT+LPTIO

- Function: Enable/Disable module's nReady、nLink function.
- Format:
  - ◆ Query Operation:  
**AT+LPTIO<CR>**  
**+ok=<status><CR><LF><CR><LF>**
  - ◆ Set Operation:  
**AT+LPTIO=<status><CR>**  
**+ok<CR><LF><CR><LF>**
- Parameters:
  - ◆ staus: Enable/Disable nReady、nLink function.
    - lpt200: nReady、nLink、WPS function map to USR-WIFI232-S  
Pin11、Pin13、Pin14;
    - on/lpt100: nReady、nLink、WPS function map to USR-WIFI232-T  
Pin9、Pin10、Pin8;
    - off/lpb100: nReady、nLink、WPS function map to USR-WIFI232-G2  
Pin44、Pin43、Pin15;



## USR-WIFI232-T Evaluation Kit Schematic

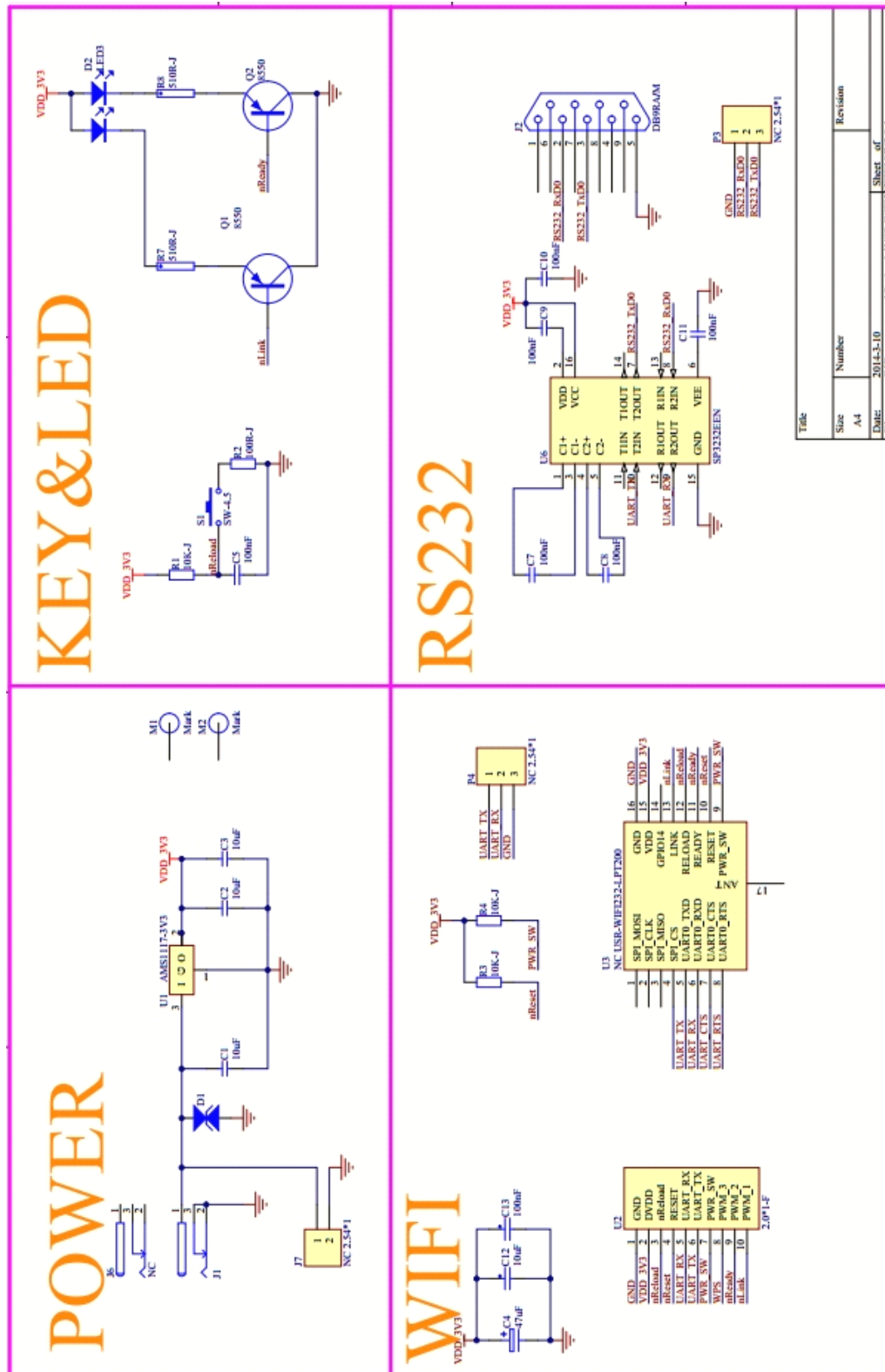

The picture shows USR-WIFI232-T evaluation kit schematic. USR-WIFI232-T evaluation board design files, please visit USR website download or contact USR engineers.

## USR-WIFI232-G2 Evaluation Kit Schematic

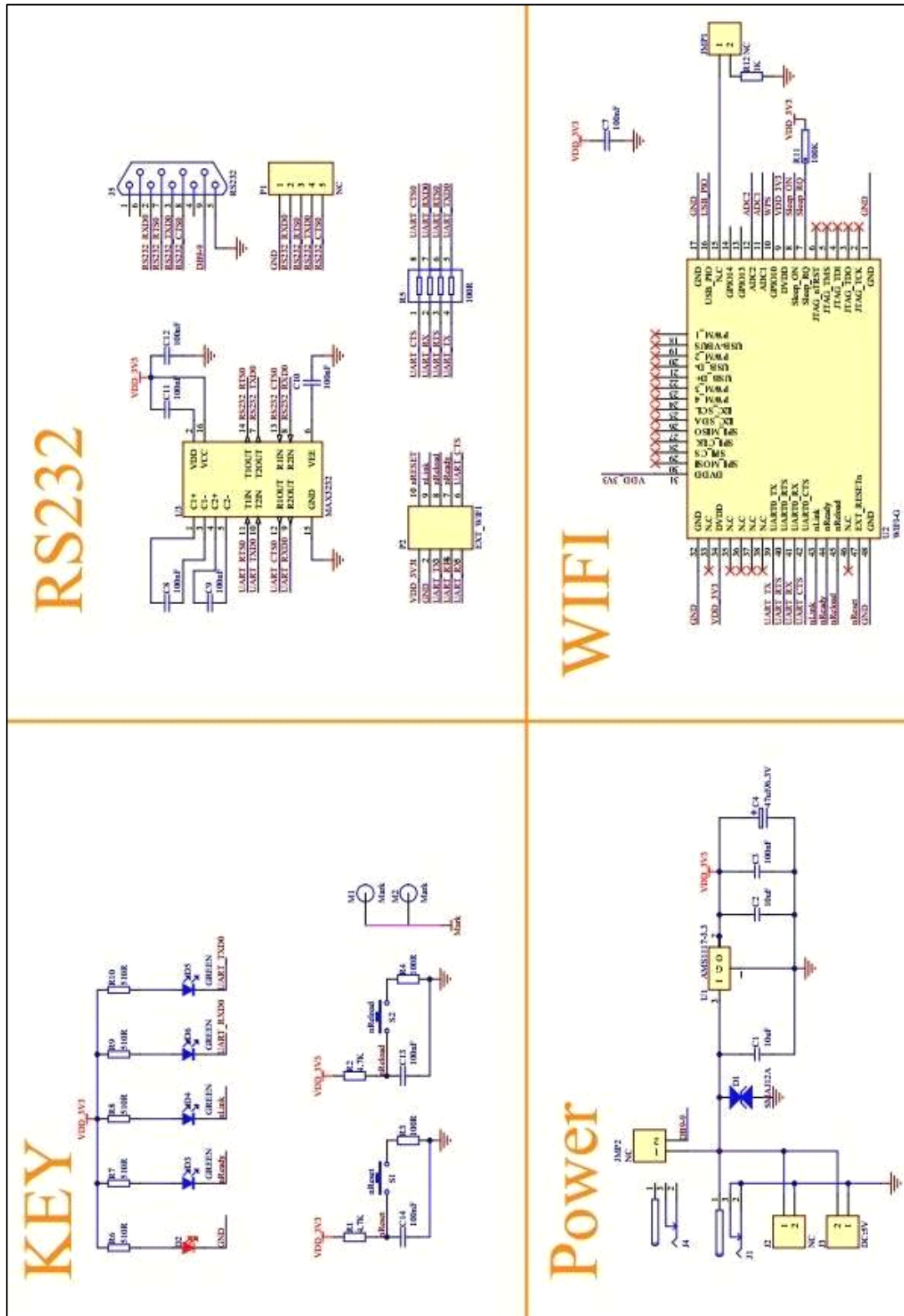

The picture shows USR-WIFI232-G2 evaluation kit schematic. USR-WIFI232-G2 evaluation board design files, please visit USR website download or contact USR engineers.



## USR-WIFI232-H Evaluation Kit Schematic

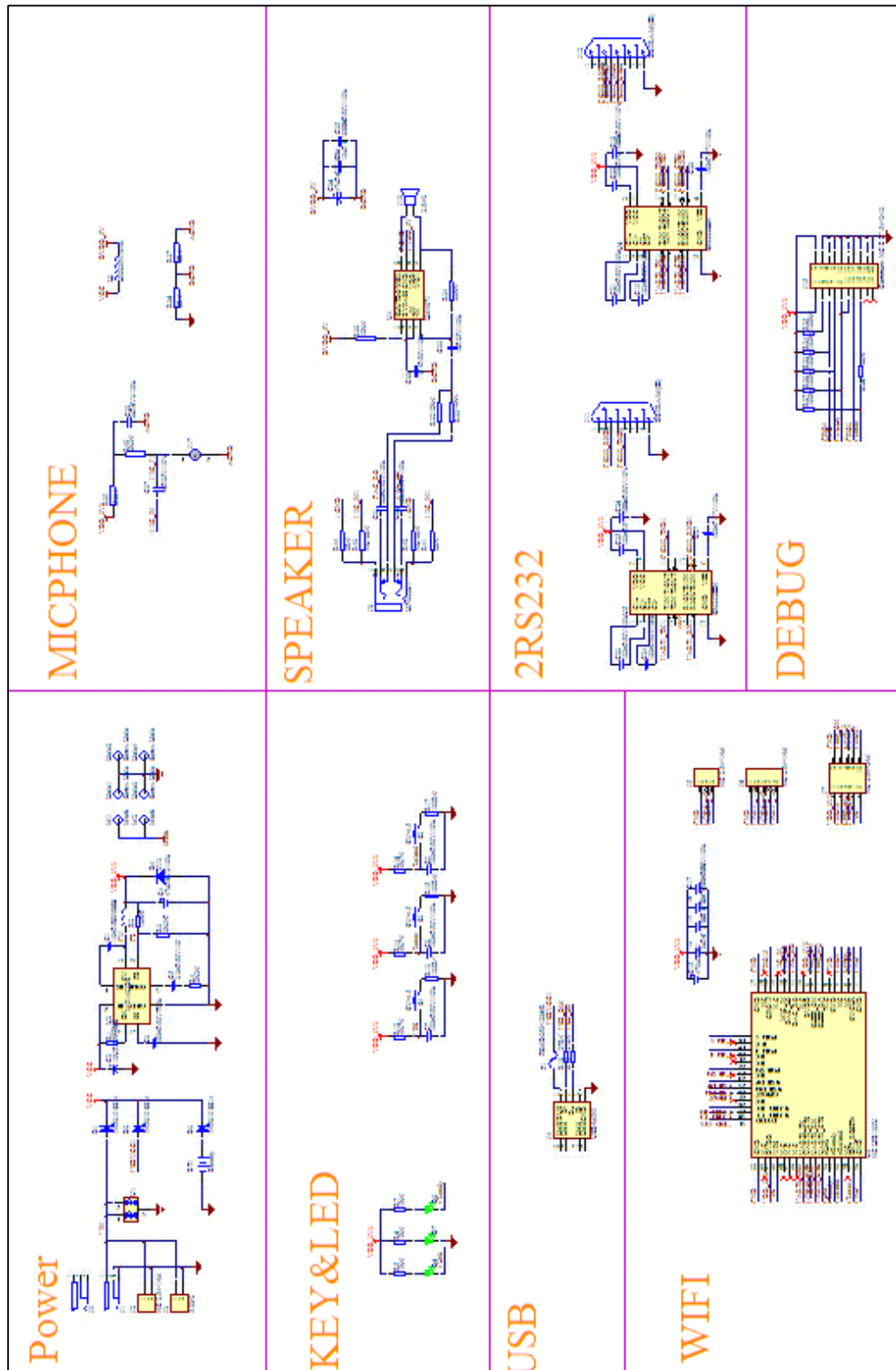

The picture shows USR-WIFI232-H evaluation kit schematic. USR-WIFI232-H evaluation board design files, please visit USR website download or contact USR engineers.

## Appendix B: GPIO/PWM CONTROL WITH NETWORK COMMANDS

User can control module's GPIO, PWM port by Send network command after make network connection to module with TCP or UDP protocol. If be saved,the status of GPIO won't be changed after the module reset. The following take USR-WIFI232-T for example.

### B.1 Network Command

#### B.1.1 GPIO <channel> OUT <value>

- Function: Set GPIO Channel value temporarily, needs to be saved if want effective after reset.
- Parameters:
  - ◆ Channel:GPIO Channel number,such as 11/12/18 for WIFI232-T ( map to Pin10/Pin9/Pin8)
  - ◆ Value: GPIO Channel value,1(high voltage), 0(low voltage)
- Return Data:
  - ◆ GPIO OK: Command successful
  - ◆ GPIO NOK: Command failed

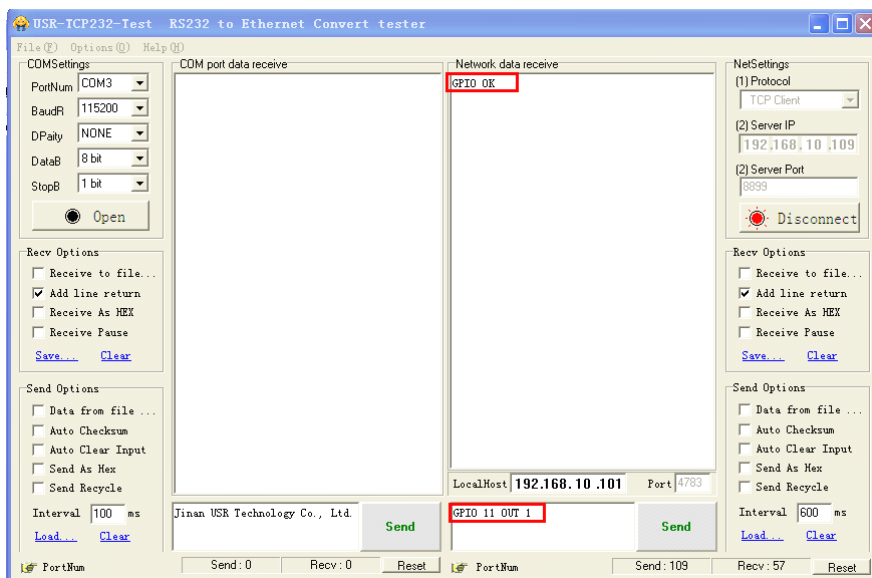

#### B.1.2 GPIO <channel> GET

- Function: Query GPIO Channel value
- Parameters:
  - ◆ channel:GPIO Channel number,such as 11/12/18 for WIFI232-T ( map to Pin10/Pin9/Pin8)
- Return Data:
  - ◆ +ok=<value>
    - Value: GPIO Channel value,1(high voltage), 0(low voltage)
  - ◆ GPIO NOK: Command failed

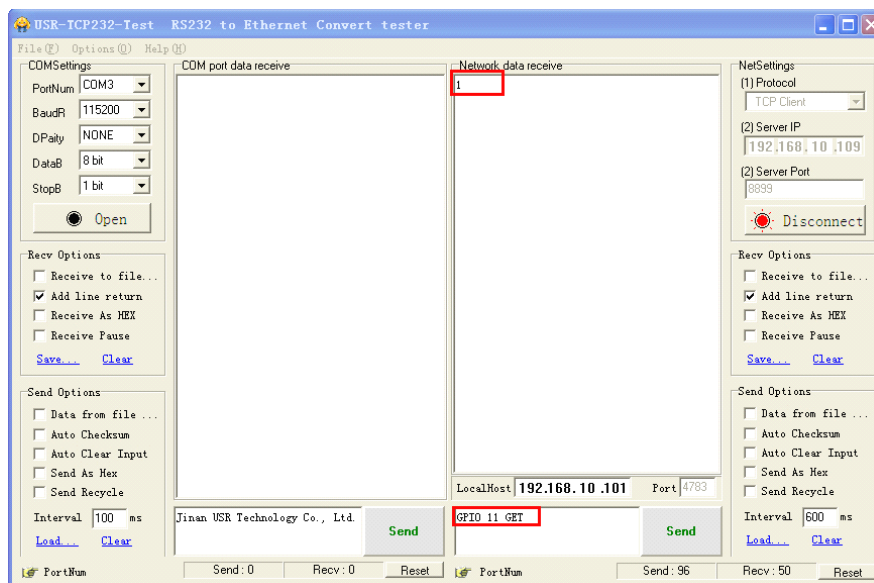

### B.1.3 GPIO <channel> SET

- Function: Save GPIO Channel setting
- Parameters:
  - ◆ channel:GPIO Channel number,such as 11/12/18 for WIFI232-T ( map to Pin10/Pin9/Pin8)
- Return Data:
  - ◆ GPIO OK: Command successful
  - ◆ GPIO NOK: Command failed

### B.1.4 PWM <channel frequency duty>

- Function: Set PWM Channel value temporarily, needs to be saved if want effective after reset.
- Parameters:
  - ◆ channel:PWM Channel number,such as 11/12/18 for WIFI232-T ( map to Pin10/Pin9/Pin8)
  - ◆ frequency: PWM Channel frequency, it can be 500~60000;
  - ◆ duty:PWM Channel duty, it can be 0~100.
- Return Data:
  - ◆ PWM OK: Command successful
  - ◆ PWM NOK: Command failed

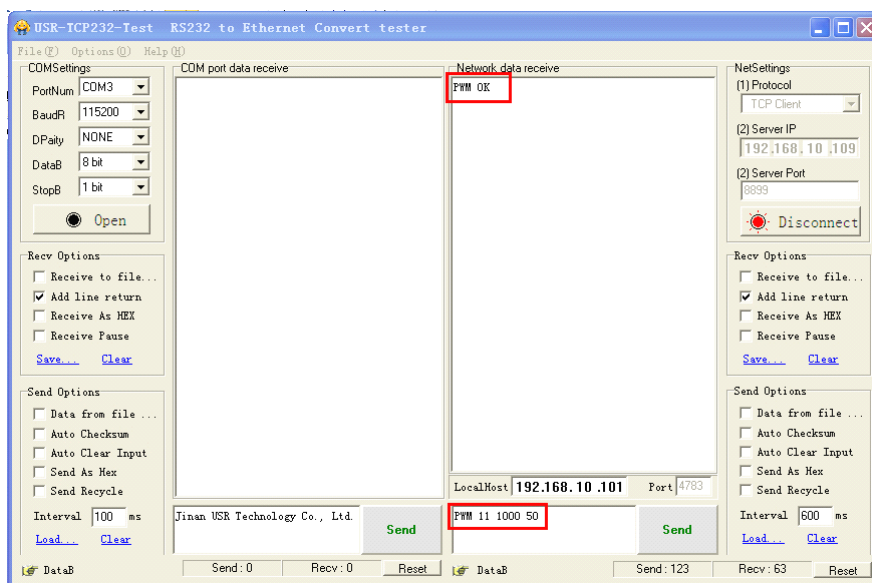

### B.1.5 PWM <channel> GET

- Function: Query PWM Channel output
- Parameters:
  - ◆ channel: PWM Channel number, such as 11/12/18 for WIFI232-T (map to Pin10/Pin9/Pin8)
- Return Data:
  - ◆ +ok=<frequency duty>
    - Frequency: PWM Channel frequency
    - Duty: PWM Channel duty
  - ◆ PWM NOK: Command failed

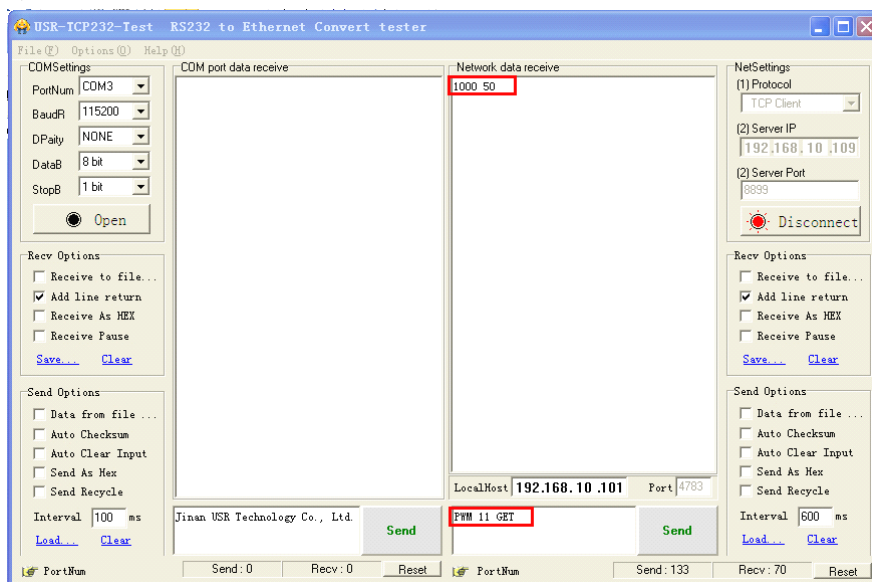

### B.1.6 PWM <channel> SET

- Function: Save PWM Channel setting
- Parameters:
  - ◆ channel: PWM Channel number, such as 11/12/18 for WIFI232-T (map to Pin10/Pin9/Pin8)
- Return Data:

- ◆ PWM OK: Command successful
- ◆ PWM NOK: Command failed

## B.2 Hexadecimal Network Command

Send hexadecimal data to fastly read/write module's port status.

### B.2.1 Read all PWM Channel Frequency

- Send Data: **【30】**
- Return Data: **【b0 <value1 value2 value3 value4 value5 value6 value7 value8>】**
  - ◆ value1: High byte of PWM Channel 0(GPIO11) frequency
  - ◆ value2: Low byte of PWM Channel 0(GPIO11) frequency
  - ◆ value3: High byte of PWM Channel 1(GPIO12) frequency
  - ◆ value4: Low byte of PWM Channel 1(GPIO12) frequency
  - ◆ value5: High byte of PWM Channel 2(GPIO18) frequency
  - ◆ value6: Low byte of PWM Channel 2(GPIO18) frequency
  - ◆ value7: no used
  - ◆ value8: no used

### B.2.2 Write PWM Channel Frequency

- Send Data: **【32 <channel value1 value2>】**
  - ◆ channel: PWM Channel number
  - ◆ value1: High byte of PWM Channel frequency
  - ◆ value2: Low byte of PWM Channel frequency
- Return Data: **【b2 <channel value1 value2>】**
  - ◆ Channel: PWM Channel number
  - ◆ value1: High byte of PWM Channel frequency
  - ◆ value2: Low byte of PWM Channel frequency

### B.2.3 Read All PWM Channel Duty

- Send Data: **【20】**
- Return Data: **【a0 <value1 value2 value3 value4>】**
  - ◆ value1: Duty of PWM Channel 0
  - ◆ value2: Duty of PWM Channel 1
  - ◆ value3: Duty of PWM Channel 2
  - ◆ value4: no used

### B.2.4 Write PWM Channel Duty

- Send Data: **【22 <channel value1>】**
  - ◆ channel: PWM Channel number
  - ◆ value1: Duty of PWM Channel
- Return Data: **【a2 <channel value1>】**
  - ◆ Channel: PWM Channel number
  - ◆ value1: Duty of PWM Channel

### B.2.5 Save Present GPIO/PWM Setting

- Send Data: **【7a】**
- Return Data: **【fa】**

### B.2.6 Read Resources of Module

- Send Data: **【7e】**
- Return Data: **【fe <value1 value2 value3>】**

- ◆ value1: Module's GPIO output pin number
- ◆ value2: Module's GPIO input pin number
- ◆ value3: Module's PWM pin number

## Appendix C: HTTP PROTOCOL TRANSFER

Module support simple http data transfer in command mode. If user need to implement complex HTTP data transfer, please confirm with USR engineer.

### C.1 HTTP AT command

#### C.1.1 AT+ HTTPURL

- Function:Set /Query HTTP server IP address and Port Number.
- Format:
  - ◆ Query Operation:  
**AT+HTTPURL<CR>**  
**+ok=<IP,Port><CR>< LF ><CR>< LF >**
  - ◆ Set Operation:  
**AT+HTTPURL=<IP,Port><CR>**  
**+ok<CR>< LF ><CR>< LF >**
- Parameters:
  - ◆ IP:HTTP server IP address.
  - ◆ Port; HTTP server Port number。

#### C.1.2 AT+ HTTPTP

- Function:Set /Query HTTP request type.
- Format:
  - ◆ Query Operation:  
**AT+HTTPTP<CR>**  
**+ok=<Type><CR>< LF ><CR>< LF >**
  - ◆ Set Operation:  
**AT+HTTPTP=<Type><CR>**  
**+ok<CR>< LF ><CR>< LF >**
- Parameters:
  - ◆ Type: GET(default) or POST.

#### C.1.3 AT+ HTTPPH

- Function:Set/Query HTTP protocol header path.
- Format:
  - ◆ Query Operation:  
**AT+HTTPPH<CR>**  
**+ok=<Path><CR>< LF ><CR>< LF >**
  - ◆ Set Operation:  
**AT+HTTPPH=<Path><CR>**  
**+ok<CR>< LF ><CR>< LF >**
- Parameters:
  - ◆ Path: Max length is 50 bytes.

#### C.1.4 AT+ HTTPCN

- Function:Set/Query Connection of HTTP protocol header.
- Format:

- ◆ Query Operation:  
**AT+HTTPCN<CR>**  
**+ok=<Connection><CR>< LF ><CR>< LF >**
  - ◆ Set Operation:  
**AT+HTTPCN=<Connection><CR>**  
**+ok<CR>< LF ><CR>< LF >**
  - Parameters:
    - ◆ Connection: Max length is 20 bytes.
- C.1.5 AT+ HTTPUA
- Function: Set/Query User-Agent of HTTP protocol header.
  - Format:
    - ◆ Query Operation:  
**AT+HTTPUA<CR>**  
**+ok=<Parameter><CR>< LF ><CR>< LF >**
    - ◆ Set Operation:  
**AT+HTTPUA=<Parameter><CR>**  
**+ok<CR>< LF ><CR>< LF >**
  - Parameters:
    - ◆ Parameter: Max length is 20 bytes.
- C.1.6 AT+ HTTPDPT
- Function: Send HTTP request or data.
  - Format:
    - ◆ Query Operation:  
**AT+HTTPDPT=<Data><CR>**  
**+ok<CR>< LF ><CR>< LF >**
  - Parameters:
    - ◆ Data: HTTP request data, send AT+HTTPDPT directly if no data to be sent.

## C.2 HTTP Example

HTTP parameter settings are as follows:

AT+HTTPURL=192.168.1.1,80	Set HTTP server address and port
AT+HTTPTP=POST	Set HTTP request type
AT+HTTPPH=/abcd	Set HTTP protocol header path
AT+HTTPCN= keep-alive	Set HTTP Connection area
AT+HTTPUA= lwip1.3.2	Set HTTP User-Agent area

If send "AT+HTTPDPT", the data packet will be sent as the following instance including the two new line:

```
POST /abcd HTTP/1.1
Connection:keep-alive
User-Agent:lwip1.3.2
Content-Length:0
Host:192.168.0.127:8999
```



If send AT+HTTPDT=abcd, the data packet will be sent as the following instance:

```
POST /abcd HTTP/1.1
Connection:keep-alive
User-Agent:lwip1.3.2
Content-Length:4
Host:192.168.0.127:8999
```

```
abcd
```

The data received from HTTP server will be output to serial port and end with "+ok".

If the module hasn't received data from HTTP server for 5 second, it will cut the TCP link with HTTP server.

## Appendix D: Contact Information

-----  
Company: Jinan USR IOT Technology Limited  
Address: 1-728, Huizhan Guoji Cheng, Gaoxin Qu, Jinan, Shandong, China  
Tel: 86-531-55507297 86-531-88826739-803  
Web: <http://en.usr.cn>  
Email: [sales@usr.cn](mailto:sales@usr.cn), [order@usr.cn](mailto:order@usr.cn)  
-----

## Appendix E: Disclaimer

This document provides information about USR-WIFI232-S/T/G2 modules, this document does not grant any license to intellectual property rights. Except the responsibility declared in the product sale clause, USR does not assume any other responsibilities. In addition, USR does not make any warranties for the sale and use of this product, including the suitability of the product for a particular purpose, merchantability or fitness for any patent, copyright or other intellectual property infringement, etc. USR may make changes to specifications and product descriptions without notice.

## Appendix F: Update History

- |       |             |   |
|-------|-------------|---|
| V 0.1 | 06-09-2013. | First Version   |
| V 1.1 | 09-11-2013. | Update AT command.Add AT+MDCH、 AT+UARTFT command,improve UDP/Server function<br>in AT+NETP command.         |
| V 1.2 | 10-12-2013. | Update AT command.Add AT+LPTIO.Update PWM/GPIO function. Add HTTP protocol demo. Add auto-frame function.   |
| V 1.3 | 10-18-2013. | Add nReload and nLink Pin description,  |
| V 2.0 | 03-20-2014. | Update evaluation board circuit.Update AT commands.Add AT + WALK,AT + WALKIND, AT + WPS,AT + SMTLK command. |
| V 2.1 | 04-14-2014. | Update AT commands.   |
| V 2.2 | 06-03-2014. | Add USR-WIFI232-H Introduction.   |

**<END>**